

CINCON ELECTRONICS

LOW POWER 1-60W DC-DC CONVERTER CATALOG 2019

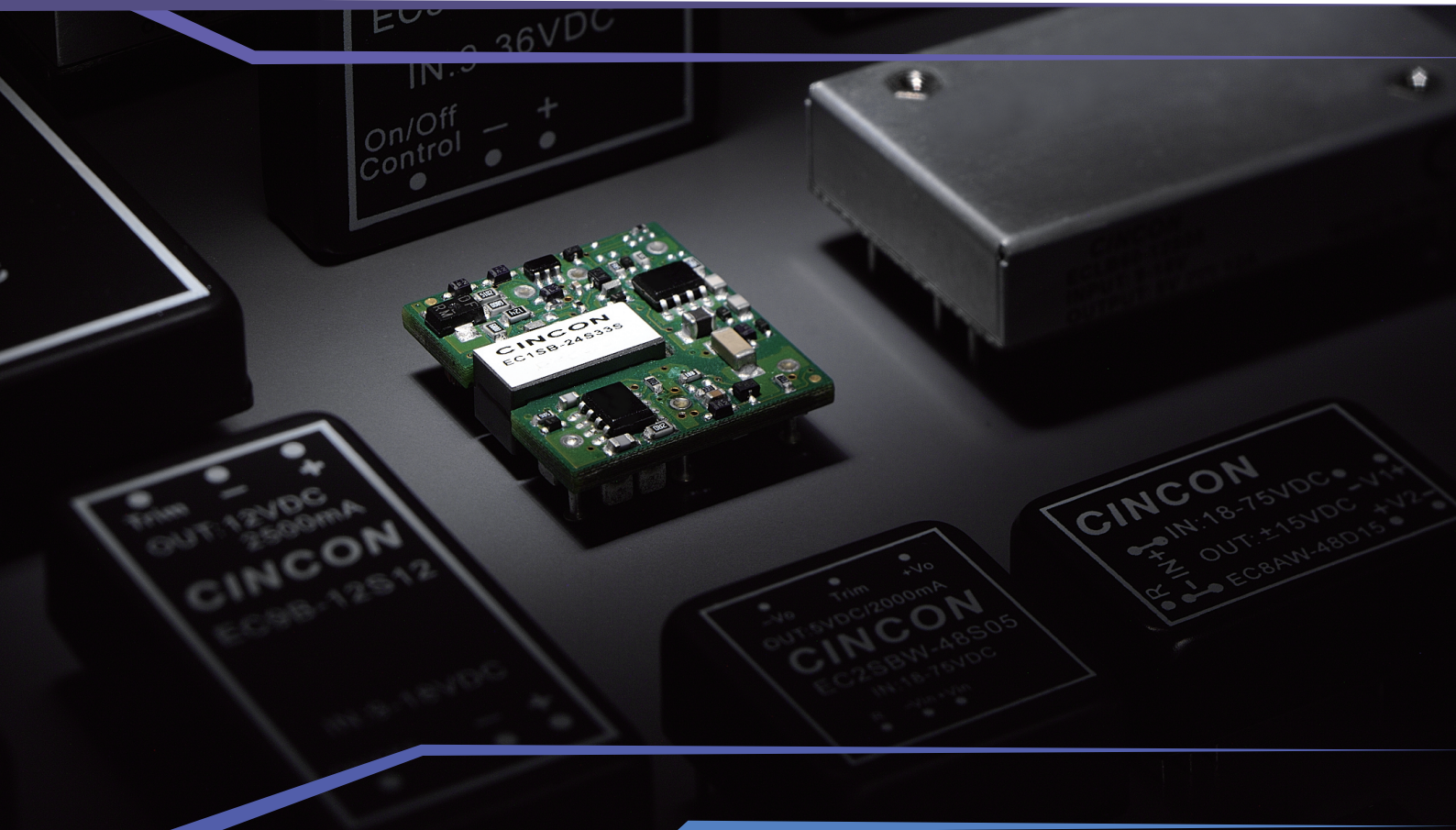

CONTENTS

QUICK SELECTION		2	EC6A	7.5W	46	EC7B	20W	84
EC1TAN	1W	4	EC6AW	8W	48	EC7BW	20W	86
EC1SAN	1W	6	NEW EC6AW-110	10W	50	EC7BW-110	20W	88
EC2SA	2W	8	EC7A	10W	52	NEW EC7BW18	20W	90
EC2SAN	2W	10	EC8AW	15W	54	EC9BW	30W	92
NEW EC2SANH	2W	12	EC2SB	10W	56	ECLB40W	40W	94
EC3SA	3W	14	EC2SBW	10W	58	ECLB40W-110	40W	96
EC3SAW	3W	16	EC3SB	15W	60	ECLB60W	60W	98
EC4SAW	6W	18	EC3SBW	15W	62	NEW ECLB75W	75W	100
NEW EC5SAW	10W	20	EC4SBW	20W	64	EC1SC	20W	102
NRND EC2A	1.5W	22	EC5SBW	30W	66	NRND EC3SCW	30W	104
EC3A	3W	24	NRND EC3B	7.5W	68	NRND EC3C	15W	106
EC3AE	3W	26	NRND EC3BB	7.5W	70	EC5C	15W	108
EC3A-E	3W	28	EC4BE	10W	72	EC6C	30W	110
EC3AB	3W	30	EC4BW	10W	74	EC7C	40W	112
EC3AW	3W	32	EC4BU	10W	76	NRND EC6E	30W	114
EC4A	6W	34	EC5BE	15W	78	REQUEST FOR QUOTE		116
EC4A-E	6W	36	EC5BW	15W	80			
EC4AB	6W	38	EC5BU	15W	82			
EC4AW	6W	40						
EC4AW-H6	6W	42						
EC5A	6-24W	44						

QUICK SELECTION

OUTPUT	INPUT VOLTAGE	OUTPUT VOLTAGE	PACKAGE	ISOLATION	EFF %	Series	PAGE
1W	5V, 12V, 24V	5V, 12V, 15V	SIP 4	1000VDC	82.0%	EC1TAN	4
	5V, 12V, 24V	5V, 12V 15V, +/-5V, +/-12V, +/-15V	SIP 7 / SMD	1500VDC	83.0%	EC1SAN	6
1.5W	5V, 12V, 24V, 28V, 48V	5V, 12V, 15V, +/-12V, +/-15V	DIP 24	500, 1500, 3000VDC	50.0%	EC2A	22
2W	4.5-9V, 9-18V, 18-36V, 36-75V	3.3V, 5V, 12V, 15V, +/-5V, +/-12V, +/-15V	SIP 8	1500VDC	84.0%	EC2SA	8
	5V, 12V, 24V	5V, 12V 15V, +/-5V, +/-12V, +/-15V	SIP 7	1000VDC	86.0%	EC2SAN	10
	5V, 12V, 24V	5V, 12V 15V, +/-5V, +/-12V, +/-15V	SIP 7	3000VDC	87.0%	EC2SANH	12
3W	4.5-6V, 9-18V, 18-36V, 36-72V	3.3V, 5V, 12V, 15V, +/-5V, +/-12V, +/-15V	DIP 24	500, 1500, 3000VDC	82.0%	EC3A	24
	4.5-9V, 9-18V, 18-36V, 36-72V	3.3V, 5V, 12V, 15V, +/-5V, +/-12V, +/-15V	DIP 24	500, 1500, 3000VDC	87.0%	EC3A-E	28
	4.5-9V, 9-18V, 18-36V, 36-75V	3.3V, 5V, 12V, 15V, +/-5V, +/-12V, +/-15V	SIP 8	1500VDC	86.0%	EC3SA	14
	5V, 12V, 24V, 28V, 48V	5V, 12V, 15V, +/-12V, +/-15V	DIP 24	500VDC	61.0%	EC3AE	26
	9-18V, 18-36V, 36-72V	3.3V, 5V, 12V, 15V, +/-5V, +/-12V, +/-15V	DIP 24	500, 1500, 3000VDC	80.0%	EC3AB	30
	9-36V, 18-75V	3.3V, 5V, 12V, 15V, +/-5V, +/-12V, +/-15V	SIP 8	1500VDC	85.0%	EC3SAW	16
	9-36V, 18-72V	3.3V, 5V, 12V, 15V, +/-5V, +/-12V, +/-15V	DIP 24	500, 1500, 3000VDC	77.0%	EC3AW	32
6W	4.7-6V, 9-32V	3.3V	DIP 24	Non-Isolation	84.0%	EC5A	44
	9-18V, 18-36V, 36-72V	3.3V, 5V, 12V, 15V, +/-5V, +/-12V, +/-15V	DIP 24	500, 1500, 3000VDC	84.0%	EC4A	34
	9-18V, 18-36V, 36-72V	3.3V, 5V, 12V, 15V, +/-5V, +/-12V, +/-15V	DIP 24	500, 1500, 3000VDC	87.0%	EC4A-E	36
	9-18V, 18-36V, 36-72V	3.3V, 5V, 12V, 15V, +/-5V, +/-12V, +/-15V	DIP 24	500, 1500, 3000VDC	84.0%	EC4AB	38
	9-36V, 18-72V	3.3V, 5V, 12V, 15V, +/-5V, +/-12V, +/-15V	DIP 24	1500, 3000VDC	83.0%	EC4AW	40
	9-36V, 18-72V	5V, 12V, +/-12V, +/-15V	DIP 24	6000VDC	85.0%	EC4AW-H6	42
	9-36V, 18-75V	3.3V, 5V, 12V, 15V, +/-5V, +/-12V, +/-15V	SIP 8	1500VDC	87.0%	EC4SAW	18
7.5W	9-18V, 18-36V, 36-72V	3.3V, 5V, 12V, 15V, +/-5V, +/-12V, +/-15V	DIP 24	1500VDC	87.0%	EC6A	46
	9-18V, 18-36V, 36-72V	3.3V, 5V, 12V, 15V, +/-5V, +/-12V, +/-15V	2" x 1"	1500VDC	87.0%	EC3B	68
	9-18V, 18-36V, 36-72V	3.3V, 5V, 12V, 15V, +/-5V, +/-12V, +/-15V	2" x 1"	1500VDC	87.0%	EC3BB	70
8W	9-36V, 18-75V	3.3V, 5V, 12V, 15V, +/-5V, +/-12V, +/-15V	DIP 24	1500VDC	87.0%	EC6AW	48
10W	4.7-9V, 9-18V, 18-36V, 36-75V	3.3V, 5V, 12V 15V, +/-5V, +/-12V, +/-15V	1" x 1"	1500VDC	87.0%	EC2SB	56
	4.7-9V, 9-18V, 18-36V, 36-75V	3.3V, 5V, 12V, 15V, +/-5V, +/-12V, +/-15V	2" x 1"	1500VDC	87.0%	EC4BU	76
	9-18V, 18-36V, 36-72V	5V, 12V 15V, +/-5V, +/-12V, +/-15V	2" x 1"	500VDC	82.0%	EC4BE	72
	9-18V, 18-36V, 36-75V	2.5V, 3.3V, 5V, 12V 15V, +/-12V, +/-15V	DIP 24	1500VDC	89.0%	EC7A	52
	9-32V	5V, 12V, 15V	DIP 24	Non-Isolation	88.0%	EC5A	44
	9-36V, 18-75V	3.3V, 5V, 12V 15V, +/-5V, +/-12V, +/-15V	SIP 8	3000VDC	89.0%	EC5SAW	20
	9-36V, 18-72V	3.3V, 5V, 12V 15V, +/-5V, +/-12V, +/-15V	2" x 1"	500VDC	82.0%	EC4BW	74
	9-36V, 18-75V	3.3V, 5V, 12V 15V, +/-5V, +/-12V, +/-15V	1" x 1"	1500VDC	86.0%	EC2SBW	58
	43-160V	3.3V, 5V, 12V 15V, +/-5V, +/-12V, +/-15V	DIP 24	3000VDC	88.5%	EC6AW-110	50

Modified Product Support

Recognizing the requirements for matching standard products to unique applications, Cincon is dedicated to provide support for customers requiring additional features or modification to catalog products.

OUTPUT	INPUT VOLTAGE	OUTPUT VOLTAGE	PACKAGE	ISOLATION	EFF %	Series	PAGE
15W	9-18V, 18-36V, 36-72V	3.3V, 5V, 12V 15V, +/-5V, +/-12V, +/-15V	2" x 1"	500VDC	82.0%	EC5BE	78
	9-18V, 18-36V, 36-72V	3.3V, 5V, 12V 15V, +/-5V, +/-12V, +/-15V	2" x 2"	500VDC	82.0%	EC3C	106
	9-18V, 18-36V, 36-75V	3.3V, 5V, 12V 15V, +/-5V, +/-12V, +/-15V	1" x 1"	1500VDC	90.0%	EC3SB	60
	9-18V, 18-36V, 36-75V	3.3V, 5V, 12V 15V, +/-5V, +/-12V, +/-15V	2" x 1"	1500VDC	90.0%	EC5BU	82
	9-36V, 18-72V	3.3V,5V,12V,15V,+/-5V,+/-12V,+/-15V,5 &+/-12V,5&+/-15V	2" x 2"	500VDC	84.0%	EC5C	108
	9-36V, 18-75V	3.3V, 5V, 12V 15V, +/-12V, +/-15V	DIP 24	1500VDC	90.0%	EC8AW	54
	9-36V, 18-75V	3.3V, 5V, 12V 15V, +/-5V, +/-12V, +/-15V	1" x 1"	1500VDC	88.0%	EC3SBW	62
	9-36V, 18-75V	3.3V, 5V, 12V 15V,+/-5V, +/-12V, +/-15V	2" x 1"	1500VDC	88.0%	EC5BW	80
19.2W	16-32V	12V	DIP 24	Non-Isolation	93.0%	EC5A	44
20W	9-18V, 18-36V, 36-75V	1.8V, 2.5V, 3.3V, 5V, 12V 15V, +/-12V, +/-15V	2" x 1"	1500VDC	90.0%	EC7B	84
	9-36V, 18-75V	3.3V, 5V, 12V 15V, +/-12V, +/-15V	1" x 1"	1500VDC	90.5%	EC4SBW	64
	9-36V, 18-72V	3.3V, 5V, 12V 15V, +/-5V, +/-12V, +/-15V	2" x 1.6"	1500VDC	84.0%	EC1SC	102
	9-36V, 18-75V	3.3V, 5V, 12V 15V,+/-5V, +/-12V, +/-15V	2" x 1"	1500VDC	90.0%	EC7BW	86
	8.5-160V	5V, 12V 15V, +/-12V, +/-15V, +/-24V	2" x 1"	3000VAC	90.0%	EC7BW18	90
	43-160V	5V, 12V, 15V, +/-12V, +/-15V	2" x 1"	3000VDC	90.0%	EC7BW-110	88
24W	19-32V	15V	DIP 24	Non-Isolation	94.0%	EC5A	44
30W	9-18V, 18-36V, 36-72V	3.3V,5V,12V,15V,+/-5V,+/-12V,+/-15V,5 &+/-12V,5&+/-15V	2" x 2"	500VDC	88.0%	EC6C	110
	9-36V, 18-72V	5V,12V,15V,+/-12V,+/-15V,5&+/-12V,5 &+/-15V, +5/+12/-5V	2.56" x 3"	500VDC	84.0%	EC6E	114
	9-36V, 18-75V	3.3V, 5V, 12V 15V, +/-12V, +/-15V	1" x 1"	500VDC	90.0%	EC5SBW	66
	9-36V, 18-75V	3.3V, 5V, 12V 15V, +/-12V, +/-15V	2" x 1"	1500VDC	92.0%	EC9BW	92
	9-36V, 18-75V	3.3V, 5V, 12V 15V	2" x 1.6"	1500VDC	91.0%	EC3SCW	104
40W	9-18V, 18-36V, 36-75V	2.5V,3.3V,5V,12V,15V,+/-12V,+/-15V,3.3 &5V,+/-12V,3.3&+/-15V,5&+/-12V,5&+/-15V	2" x 2"	1500VDC	93.0%	EC7C	112
	9-36V, 18-75V	3.3V, 5V, 12V 15V, +/-12V, +/-15V	2.05" x 1.2"	1500VDC	91.0%	ECLB40W	94
	43-160V	3.3V, 5V, 12V 15V,+/-24V, +/-12V, +/-15V	2.05" x 1.2"	3000VDC	91.0%	ECLB40W-110	96
60W	9-36V, 18-75V	3.3V, 5V, 12V 15V, +/-12V, +/-15V	2.05" x 1.2"	1500VDC	92.0%	ECLB60W	98
75W	9-36V, 18-75V	5V, 12V 15V, +/-12V, +/-15V, +/-24V	2.05" x 1.2"	2250VDC	92.0%	ECLB75W	100

ECTAN SERIES

1 WATT, UNREGULATED OUTPUT

Features

- ◆ Industry Standard SIP Packages
- ◆ Efficiency up to 82%
- ◆ 1000VDC Isolation
- ◆ Low Cost
- ◆ Unregulated Outputs
- ◆ Low Ripple and Noise
- ◆ No Tantalum Capacitors Inside

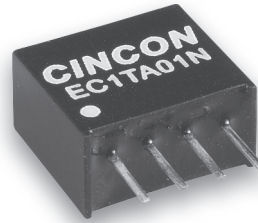

Mechanical Dimensions

All Dimensions in Inches (mm)

Tolerance	Inches	Millimeters
	X.XX±0.01	X.X±0.25
Pin	±0.002	±0.05

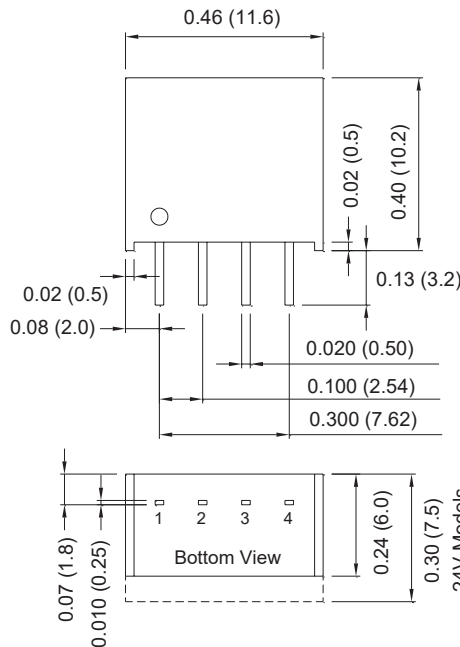

PIN CONNECTION	
PIN	Single Output
1	-V Input
2	+V Input
3	-V Output
4	+V Output

MODEL NUMBER	INPUT VOLTAGE	OUTPUT VOLTAGE	OUTPUT CURRENT	INPUT CURRENT		% EFF.	CAPACITOR LOAD MAX.
				NO LOAD	FULL LOAD		
EC1TA01N	5 VDC	5 VDC	200 mA	40 mA	253 mA	79	220µF
EC1TA02N	5 VDC	12 VDC	84 mA	40 mA	255 mA	79	220µF
EC1TA03N	5 VDC	15 VDC	67 mA	40 mA	251 mA	80	220µF
EC1TA11N	12 VDC	5 VDC	200 mA	15 mA	103 mA	81	220µF
EC1TA12N	12 VDC	12 VDC	84 mA	15 mA	103 mA	81	220µF
EC1TA13N	12 VDC	15 VDC	67 mA	15 mA	102 mA	82	220µF
EC1TA21N	24 VDC	5 VDC	200 mA	7 mA	52 mA	80	220µF
EC1TA22N	24 VDC	12 VDC	84 mA	7 mA	52 mA	80	220µF
EC1TA23N	24 VDC	15 VDC	67 mA	7 mA	52 mA	81	220µF

NOTE: 1. Nominal Input Voltage 5, 12 or 24VDC

Derating Curve

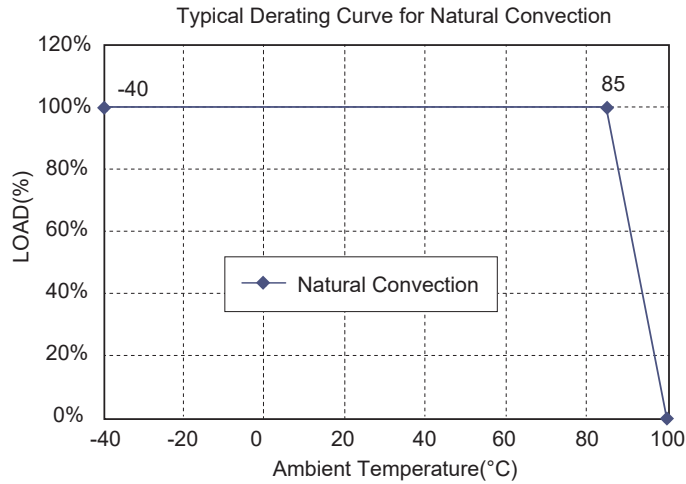

Specification

All Specifications Typical At Nominal Line, Full Load, and 25°C Unless Otherwise Noted

INPUT SPECIFICATIONS

Input Voltage Range	±10%
Input Surge Voltage (100ms max.)	5V 9Vdc max. 12V 18Vdc max. 24V 30Vdc max.
Input Filter	Capacitive

OUTPUT SPECIFICATIONS

Voltage Accuracy	±3.0% max.
Ripple and Noise, 20MHz BW	100mV pk-pk max.
Temperature Coefficient	±0.05%/°C max.
Short Circuit Protection	Momentary 1sec. max.
Line Regulation (note 1)	±1.2% max.
Load Regulation (note 2)	±10% max.

NOTE

- Line regulation is per 1.0% change in input voltage.
- Load regulation is for load change from 100% to 20%.
- The output noise is measured with 0.33µF ceramic capacitor.
- Maximum case temperature under any operating condition should not be exceeded 100°C.
- The EC1TA2XN input terminal need to parallel with 4.7µF ceramic capacitor.

GENERAL SPECIFICATIONS

Efficiency	See Table
Isolation Voltage	1000 VDC min.
Isolation Resistance	10 ⁹ ohm min.
Isolation Capacitance	10pF typ.
Switching Frequency	5 & 12V Input 90KHz typ. 24V Input 80KHz typ.
Operating Ambient Temperature Range	-40°C to +85°C
De-rating, Above 85°C	Linearly to Zero power at 100°C
Case temperature (note 4)	+100°C max.
Cooling	Natural Convection
Storage Temperature Range	-55°C to +125°C
Humidity	95% RH max. Non condensing
MTBF MIL-STD-217F, GB	1.7Mhrs min.
Dimensions:	
5 & 12V input	0.46 x 0.24 x 0.40 inches (11.6 x 6.0 x 10.2 mm)
24V input	0.46 x 0.30 x 0.40 inches (11.6 x 7.5 x 10.2 mm)
Case Material	Non-Conductive Black Plastic
Weight	5 & 12V Input 1.3 g 24V Input 1.7 g

EC1SA SERIES

1 WATT, UNREGULATED OUTPUT

Features

- ◆ Industry Standard SIP/SMD Packages
- ◆ Efficiency Up to 83%
- ◆ 1500VDC Isolation
- ◆ Low Cost
- ◆ Unregulated Outputs
- ◆ Low Ripple and Noise
- ◆ No Tantalum Capacitors Inside

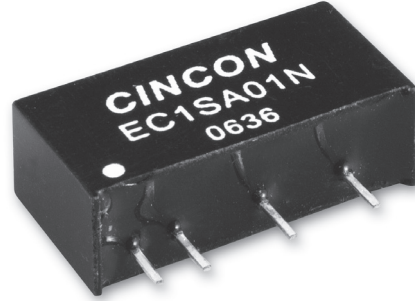

Mechanical Dimensions

All Dimensions In Inches (mm)

Tolerance	Inches	Millimeters
	X.XX±0.01	X.X±0.25
	X.XXX±0.005	X.X±0.13
Pin	±0.002	±0.05

SIP PACKAGES

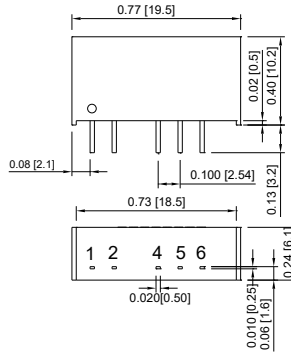

PIN CONNECTION		
Pin	Single Output	Dual Output
1	+V Input	+V Input
2	-V Input	-V Input
4	-V Output	-V Output
5	No Pin	Common
6	+V Output	+V Output

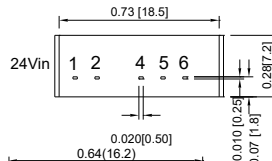

SMD PACKAGES

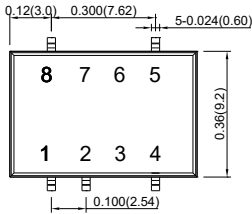

PIN CONNECTION		
Pin	Single Output	Dual Output
1	-V Input	
2	+V Input	
3	No Pin	
4	-V Output	
5	+V Output	
6	No Pin	
7	No Pin	
8	NA	

NA: Not Available for Electrical Connection

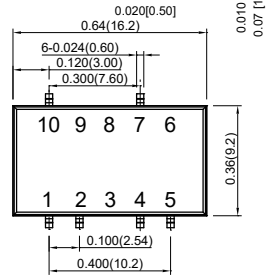

PIN CONNECTION		
Pin	Dual Output	
1	-V Input	
2	+V Input	
3	No Pin	
4	Common	
5	-V Output	
6	No Pin	
7	+V Output	
8	No Pin	
9	No Pin	
10	NA	

NA: Not Available for Electrical Connection

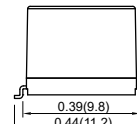
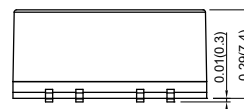
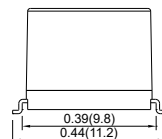
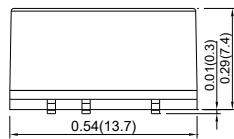

MODEL NUMBER	INPUT VOLTAGE	OUTPUT VOLTAGE	OUTPUT CURRENT	INPUT CURRENT		% EFF.	CAPACITOR LOAD MAX.
				NO LOAD	FULL LOAD		
EC1SA01N	5 VDC	5 VDC	200 mA	40 mA	253 mA	79	220µF
EC1SA02N	5 VDC	12 VDC	84 mA	40 mA	255 mA	79	220µF
EC1SA03N	5 VDC	15 VDC	67 mA	40 mA	254 mA	79	220µF
EC1SA04N	5 VDC	±12 VDC	42 mA	40 mA	258 mA	78	100µF
EC1SA05N	5 VDC	±15 VDC	33 mA	40 mA	254 mA	78	100µF
EC1SA06N	5 VDC	±5 VDC	100 mA	40 mA	270 mA	74	100µF
EC1SA11N	12 VDC	5 VDC	200 mA	15 mA	104 mA	80	220µF
EC1SA12N	12 VDC	12 VDC	84 mA	15 mA	104 mA	81	220µF
EC1SA13N	12 VDC	15 VDC	67 mA	15 mA	103 mA	81	220µF
EC1SA14N	12 VDC	±12 VDC	42 mA	15 mA	105 mA	80	100µF
EC1SA15N	12 VDC	±15 VDC	33 mA	15 mA	102 mA	81	100µF
EC1SA16N	12 VDC	±5 VDC	100 mA	15 mA	108 mA	77	100µF
EC1SA21N	24 VDC	5 VDC	200 mA	7 mA	52 mA	80	220µF
EC1SA22N	24 VDC	12 VDC	84 mA	7 mA	51 mA	83	220µF
EC1SA23N	24 VDC	15 VDC	67 mA	7 mA	52 mA	81	220µF
EC1SA24N	24 VDC	±12 VDC	42 mA	7 mA	52 mA	81	100µF
EC1SA25N	24 VDC	±15 VDC	33 mA	7 mA	50 mA	82	100µF
EC1SA26N	24 VDC	±5 VDC	100 mA	7 mA	53 mA	79	100µF

NOTE: 1. Nominal Input Voltage 5, 12 or 24VDC

Derating Curve

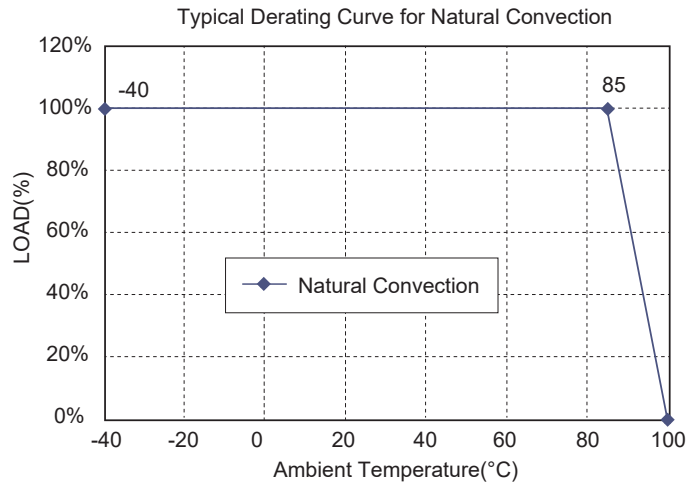

Specification

All Specifications Typical At Nominal Line, Full Load, and 25°C Unless Otherwise Noted

INPUT SPECIFICATIONS

Input Voltage Range	±10%
Input Surge Voltage (100ms max.)	5V 9Vdc max. 12V 18Vdc max. 24V 30Vdc max.
Input Filter	Capacitive

OUTPUT SPECIFICATIONS

Voltage Accuracy	±3.0% max.
Voltage Balance (Dual)	±1.0% max.
Ripple & Noise, 20MHz BW	SIP Models 75mV pk-pk max. SMD Models 120mV pk-pk max.
Temperature Coefficient	±0.05%/°C
Short Circuit Protection	Momentary 1sec. max.
Line Regulation (note 1)	±1.2% max.
Load Regulation (note 2)	±10% max.

NOTE

- Line regulation is per 1.0% change in input voltage.
- Load regulation is for load change from 100% to 20%.
- The output noise is measured with 0.33µF ceramic capacitor.
- Suffix "S" to the model number with SMD packages, 5 & 12Vin models single output only.
- Maximum case temperature under any operating condition should not be exceeded 100°C.
- The EC1SA2XN input terminal need to parallel with 4.7µF ceramic capacitor.

GENERAL SPECIFICATIONS

Efficiency	See Table
Isolation Voltage	1500 VDC min.
Isolation Resistance	10 ⁹ ohm min.
Isolation Capacitance	10pF typ.
Switching Frequency	24Vin 75KHz typ. Others 100KHz typ.
Operating Ambient Temperature Range	-40°C to +85°C
De-rating, Above 85°C	Linearly to Zero power at 100°C
Case temperature (note 5)	+100°C max.
Cooling	Natural Convection
Storage Temperature Range	-55°C to +125°C
Humidity	95% RH max. Non condensing
MTBF MIL-STD-217F, GB	1.5Mhrs min.
Dimensions	
SIP Models	0.77 x 0.24 x 0.40 inches (19.5 x 6.1 x 10.2 mm)
SIP Models (24Vin)	0.77 x 0.28 x 0.40 inches (19.5 x 7.2 x 10.2 mm)
SMD Models (Single)	0.54 x 0.36 x 0.29 inches (13.7 x 9.2 x 7.4 mm)
SMD Models(Dual)	0.64 x 0.36 x 0.29 inches (16.2 x 9.2 x 7.4 mm)
Case Material	Non-Conductive Black Plastic
Weight	24Vin 2.7 g Others 1.8 g SMD Type 1.4 g

EC2SA SERIES

2 WATT, 2:1 INPUT RANGE

Features

- ◆ 2W Isolated Output
- ◆ Compact SIP-8 Package
- ◆ Efficiency to 84%
- ◆ 2 : 1 Input Range
- ◆ Regulated Outputs
- ◆ Remote On/Off Control
- ◆ 1500VDC Isolation
- ◆ Continuous Short Circuit Protection
- ◆ Under Voltage Protection
- ◆ CE Mark Meets 2014/30/EU
- ◆ Safety Meets UL60950-1, EN60950-1, and IEC60950-1



Mechanical Dimensions

All Dimensions In Inches (mm)

Tolerance	Inches	Millimeters
	X.XX±0.02	X.X±0.5
Pin	±0.002	±0.05

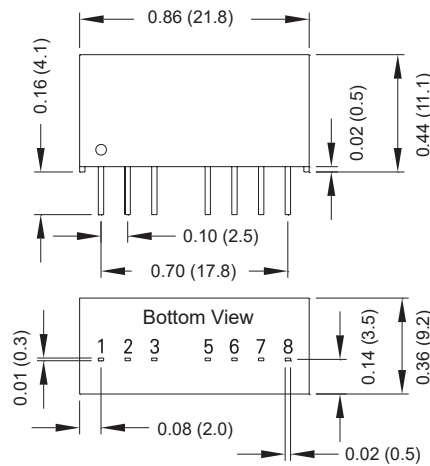

PIN CONNECTION		
PIN	Single Output	Dual Output
1	-Vin	-Vin
2	+Vin	+Vin
3	On/Off	On/Off
5	NC	NC
6	+Vo	+Vo
7	-Vo	Common
8	NC	-Vo

MODEL NUMBER	INPUT VOLTAGE	OUTPUT VOLTAGE	OUTPUT CURRENT		INPUT CURRENT		% EFF.	CAPACITOR LOAD MAX.
			MIN.	MAX.	NO LOAD	FULL LOAD		
EC2SA-05S33N	4.5-9.0 VDC	3.3 VDC	0 mA	500 mA	60 mA	452 mA	73	500µF
EC2SA-05S05N	4.5-9.0 VDC	5 VDC	0 mA	400 mA	60 mA	526 mA	76	400µF
EC2SA-05S12N	4.5-9.0 VDC	12 VDC	0 mA	167 mA	60 mA	501 mA	80	167µF
EC2SA-05S15N	4.5-9.0 VDC	15 VDC	0 mA	134 mA	60 mA	503 mA	80	134µF
EC2SA-05D05N	4.5-9.0 VDC	±5 VDC	±0 mA	±200 mA	60 mA	519 mA	77	200µF
EC2SA-05D12N	4.5-9.0 VDC	±12 VDC	±0 mA	±83 mA	60 mA	504 mA	79	83µF
EC2SA-05D15N	4.5-9.0 VDC	±15 VDC	±0 mA	±67 mA	60 mA	503 mA	80	67µF
EC2SA-12S33N	9-18 VDC	3.3 VDC	0 mA	500 mA	30 mA	181 mA	76	500µF
EC2SA-12S05N	9-18 VDC	5 VDC	0 mA	400 mA	30 mA	211 mA	79	400µF
EC2SA-12S12N	9-18 VDC	12 VDC	0 mA	167 mA	30 mA	204 mA	82	167µF
EC2SA-12S15N	9-18 VDC	15 VDC	0 mA	134 mA	30 mA	202 mA	83	134µF
EC2SA-12D05N	9-18 VDC	±5 VDC	±0 mA	±200 mA	30 mA	211 mA	79	200µF
EC2SA-12D12N	9-18 VDC	±12 VDC	±0 mA	±83 mA	30 mA	202 mA	82	83µF
EC2SA-12D15N	9-18 VDC	±15 VDC	±0 mA	±67 mA	30 mA	202 mA	83	67µF
EC2SA-24S33N	18-36 VDC	3.3 VDC	0 mA	500 mA	18 mA	90 mA	76	500µF
EC2SA-24S05N	18-36 VDC	5 VDC	0 mA	400 mA	18 mA	105 mA	79	400µF
EC2SA-24S12N	18-36 VDC	12 VDC	0 mA	167 mA	18 mA	102 mA	82	167µF
EC2SA-24S15N	18-36 VDC	15 VDC	0 mA	134 mA	18 mA	101 mA	83	134µF
EC2SA-24D05N	18-36 VDC	±5 VDC	±0 mA	±200 mA	18 mA	105 mA	79	200µF
EC2SA-24D12N	18-36 VDC	±12 VDC	±0 mA	±83 mA	18 mA	102 mA	81	83µF
EC2SA-24D15N	18-36 VDC	±15 VDC	±0 mA	±67 mA	18 mA	100 mA	84	67µF
EC2SA-48S33N	36-75 VDC	3.3 VDC	0 mA	500 mA	9 mA	46 mA	74	500µF
EC2SA-48S05N	36-75 VDC	5 VDC	0 mA	400 mA	9 mA	53 mA	79	400µF
EC2SA-48S12N	36-75 VDC	12 VDC	0 mA	167 mA	9 mA	51 mA	82	167µF
EC2SA-48S15N	36-75 VDC	15 VDC	0 mA	134 mA	9 mA	50 mA	84	134µF
EC2SA-48D05N	36-75 VDC	±5 VDC	±0 mA	±200 mA	9 mA	53 mA	78	200µF
EC2SA-48D12N	36-75 VDC	±12 VDC	±0 mA	±83 mA	9 mA	51 mA	82	83µF
EC2SA-48D15N	36-75 VDC	±15 VDC	±0 mA	±67 mA	9 mA	50 mA	84	67µF

NOTE: 1. Nominal Input Voltage 5, 12, 24 or 48VDC

Derating Curve

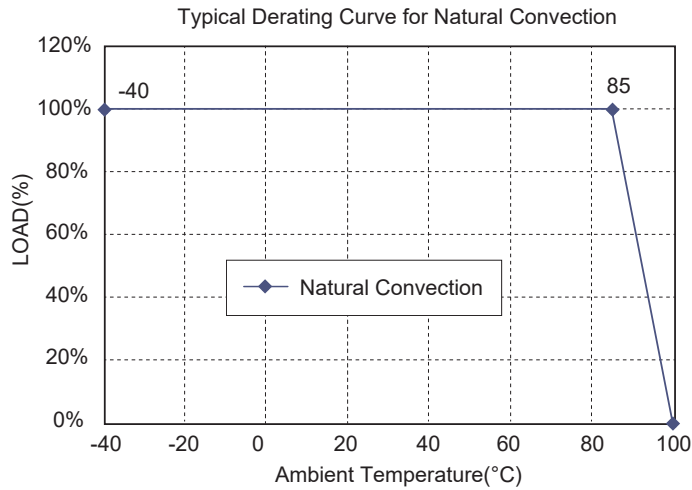

Specification

All Specifications Typical At Nominal Line, Full Load, and 25°C Unless Otherwise Noted

INPUT SPECIFICATIONS

Input Voltage Range	5V 4.5-9V
	12V 9-18V
	24V 18-36V
	48V 36-75V
Input Surge Voltage (100ms max.)	5V 15Vdc max.
	12V 25Vdc max.
	24V 50Vdc max.
	48V 100Vdc max.
Under Voltage Protection (note 5):	
5Vin	Power Up 4.2Vdc max.
	Power Down 3Vdc min.
12Vin	Power Up 7.3Vdc max.
	Power Down 5.8Vdc min.
24Vin	Power Up 15.5Vdc max.
	Power Down 12Vdc min.
48Vin	Power Up 31Vdc max.
	Power Down 24Vdc min.
Input Filter	Capacitive
Remote on/off control (note 6):	
Module Off (input idle current)	1mA max.

OUTPUT SPECIFICATIONS

Voltage Accuracy	±1.5% max.
Voltage Balance (Dual)	±1.0% max.
Cross regulation (Dual) (note 1)	Asymmetrical load
	25%/100% ±5.0% max.
Transient Response: 25% Step Load Change	
Error Band	±6% Vout nominal
Recovery Time	< 500µs
Ripple & Noise, 20MHz BW	75mV pk-pk max.
Temperature Coefficient	±0.03%/°C
Line Regulation (note 2)	±0.5% max.
Load Regulation (note 3)	±0.5% max.
	Single
	Dual
Output Short Circuit Protection	Continuous
Start up time	1ms typ.

GENERAL SPECIFICATIONS

Efficiency	See Table
Isolation Voltage	1500VDC min.
Isolation Resistance	10 ⁹ ohm min.
Isolation Capacitance	500pF typ.
Switching Frequency	100KHz min.
Operating Ambient Temperature	-40°C to +85°C
De-rating, Above 85°C	Linearly to Zero power at 100°C
Case Temperature (note 4)	100°C max.
Cooling	Natural Convection
Storage Temperature	-55°C to +125°C
Humidity	95% RH max. Non condensing
MTBF MIL-STD-217F, GB, 25°C, Full Load	2500Khrs typ.
Dimensions	0.86 x 0.36 x 0.44 inches (21.80 x 9.20 x 11.10 mm)
Case Material	Non-Conductive Black Plastic
Weight	4.8 g

NOTE

- For asymmetric loading both channels must be at 25% load or more.
- Measured from high line to low line.
- Measured from full load to 10% load.
- Maximum case temperature under any operating condition should not be exceeded 100°C.
- Suffix "N" to the model with under voltage protection.
- Suffix "N" Models: Module On 0 to < 0.8VDC or open circuit
 Module Off 4 to 15VDC
 Other Models: Module On 0 to < 1.2VDC or open circuit
 Module Off 5.5 to 15VDC

EC2SAN SERIES

2 WATT, UNREGULATED

Features

- ◆ Industry Standard SIP Packages
- ◆ Efficiency up to 86%
- ◆ 1000VDC Isolation
- ◆ Low Cost
- ◆ Unregulated Outputs
- ◆ Industry Standard Pinout
- ◆ No Tantalum Capacitors Inside

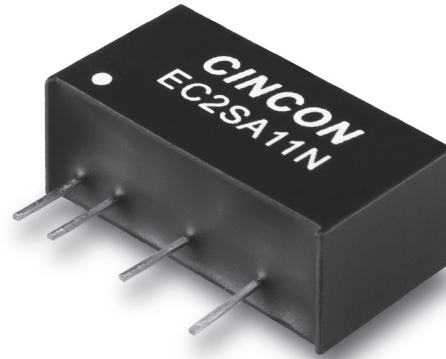

Mechanical Dimensions

All Dimensions In Inches (mm)

Tolerance	Inches	Millimeters
	X.XX±0.01	X.X±0.25
	X.XXX±0.005	X.XX±0.13
Pin	±0.002	±0.05

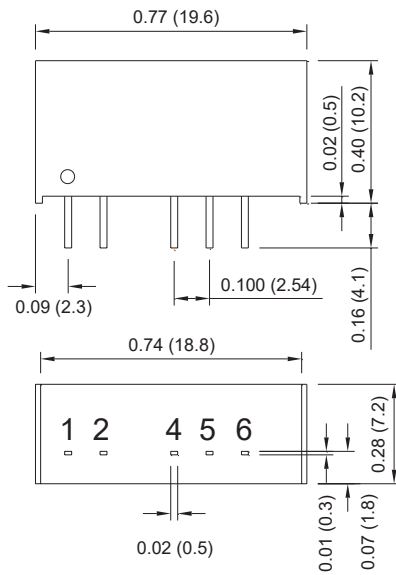

PIN CONNECTION		
PIN	Single Output	Dual Output
1	+V Input	+V Input
2	-V Input	-V Input
4	-V Output	-V Output
5	No Pin	Common
6	+V Output	+V Output

MODEL NUMBER	INPUT VOLTAGE	OUTPUT VOLTAGE	OUTPUT CURRENT	INPUT CURRENT		% EFF.	CAPACITOR LOAD MAX.
				NO LOAD	FULL LOAD		
EC2SA01N	5 VDC	5 VDC	400 mA	60 mA	488 mA	82	470µF
EC2SA02N	5 VDC	12 VDC	167 mA	60 mA	466 mA	86	470µF
EC2SA03N	5 VDC	15 VDC	134 mA	60 mA	473 mA	85	470µF
EC2SA04N	5 VDC	±12 VDC	±83 mA	60 mA	463 mA	86	470µF
EC2SA05N	5 VDC	±15 VDC	±67 mA	60 mA	467 mA	86	470µF
EC2SA06N	5 VDC	±5 VDC	±200 mA	60 mA	482 mA	83	470µF
EC2SA11N	12 VDC	5 VDC	400 mA	40 mA	203 mA	82	470µF
EC2SA12N	12 VDC	12 VDC	167 mA	40 mA	201 mA	83	470µF
EC2SA13N	12 VDC	15 VDC	134 mA	40 mA	199 mA	84	470µF
EC2SA14N	12 VDC	±12 VDC	±83 mA	40 mA	202 mA	82	470µF
EC2SA15N	12 VDC	±15 VDC	±67 mA	40 mA	199 mA	84	470µF
EC2SA16N	12 VDC	±5 VDC	±200 mA	40 mA	203 mA	82	470µF
EC2SA21N	24 VDC	5 VDC	400 mA	20 mA	105 mA	79	470µF
EC2SA22N	24 VDC	12 VDC	167 mA	20 mA	103 mA	81	470µF
EC2SA23N	24 VDC	15 VDC	134 mA	20 mA	102 mA	82	470µF
EC2SA24N	24 VDC	±12 VDC	±83 mA	20 mA	102 mA	81	470µF
EC2SA25N	24 VDC	±15 VDC	±67 mA	20 mA	102 mA	82	470µF
EC2SA26N	24 VDC	±5 VDC	±200 mA	20 mA	105 mA	79	470µF

NOTE: 1. Nominal Input Voltage 5, 12 or 24 VDC

Derating Curve

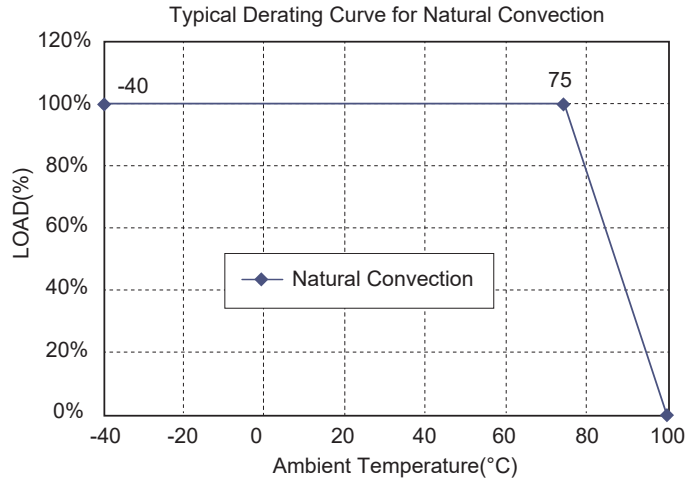

Specification

All Specifications Typical At Nominal Line, Full Load, and 25°C Unless Otherwise Noted

INPUT SPECIFICATIONS

Input Voltage Range	±10%
Input Surge Voltage (100ms max.)	5V 9Vdc max. 12V 18Vdc max. 24V 30Vdc max.
Input Filter	Capacitive

OUTPUT SPECIFICATIONS

Voltage Accuracy	±3.0% max.
Voltage Balance (Dual)	±1.0% max.
Ripple and Noise, 20MHz BW	150mV pk-pk max.
Single output, 5V	100mVpk-pk max.
Temperature Coefficient	±0.05%/°C max.
Short Circuit Protection	Momentary 1sec. max.
Line Regulation (note 1)	±1.2% max.
Load Regulation (note 2)	±10% max.

GENERAL SPECIFICATIONS

Efficiency	See Table
Isolation Voltage	1000 VDC min.
Isolation Resistance	10 ⁹ ohm min.
Isolation Capacitance	15 pF typ.
Switching Frequency	80KHz typ.
Operating Ambient Temperature Range	-40°C to +85°C
De-rating, Above 75°C	Linearly to Zero power at 100°C
Case temperature (note 4)	+100°C max.
Cooling	Natural Convection
Storage Temperature Range	-55°C to +125°C
Humidity	95% RH max. Non condensing
MTBF MIL-STD-217F,GB	3.3Mhrs min.
Dimensions	0.77 x 0.28 x 0.40 inches (19.6 x 7.2 x 10.2 mm)
Case Material	Non-Conductive Black Plastic
Weight	2.7 g

NOTE

1. Line regulation is per 1.0% change in input voltage.
2. Load regulation is for load change from 100% to 20%.
3. The output noise is measured with 0.33µF ceramic capacitor.
4. Maximum case temperature under any operating condition should not be exceeded 100°C.
5. The EC2SA2XN input terminal need to parallel with 10µF ceramic capacitor.

EC2SANH SERIES

2WATT, UNREGULATED OUTPUT DC-DC CONVERTERS

Features

- ◆ Industry Standard SIP Packages
- ◆ Efficiency up to 88%
- ◆ 3000VDC Isolation
- ◆ Low Cost
- ◆ Unregulated Outputs Industry
- ◆ Industry Standard Pinout
- ◆ No Tantalum Capacitors inside

PRELIMINARY

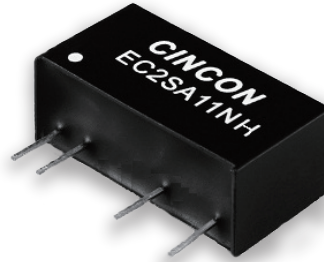

Mechanical Dimensions

All Dimensions In Inches(mm)
 Tolerance Inches Millimeters
 X.XX±0.01 X.X±0.25
 X.XXX±0.005 X.XX±0.13
 Pin ±0.002 ±0.05

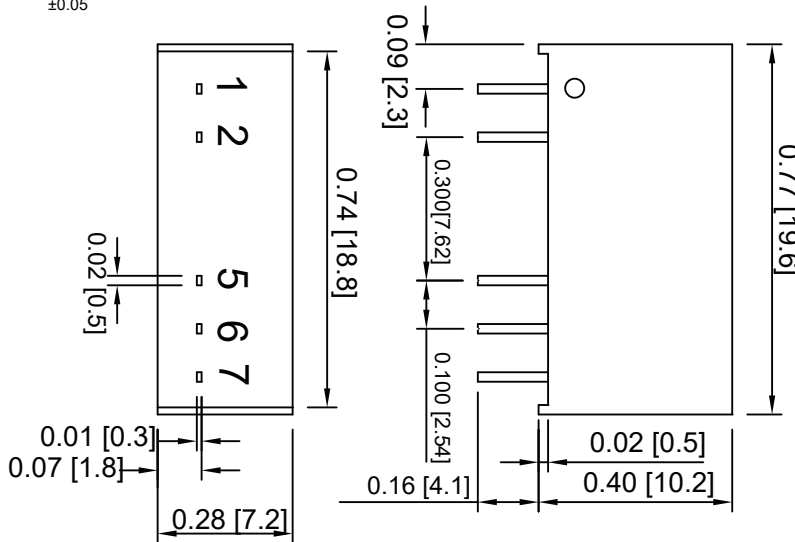

PIN CONNECTION		
PIN	Single Output	Dual Output
1	+V Input	+V Input
2	-V Input	-V Input
5	-V Output	-V Output
6	No Pin	Common
7	+V Output	+V Output

MODEL NUMBER	INPUT VOLTAGE	OUTPUT VOLTAGE	OUTPUT CURRENT	INPUT CURRENT		% EFF.	CAPACITOR LOAD MAX.
				NO LOAD	FULL LOAD		
EC2SA01NH	5 VDC	5 VDC	400 mA	40 mA	488 mA	82	220uF
EC2SA02NH	5 VDC	12 VDC	167 mA	50 mA	477 mA	84	220uF
EC2SA03NH	5 VDC	15 VDC	134 mA	55 mA	473 mA	85	220uF
EC2SA04NH	5 VDC	±12 VDC	±83 mA	50 mA	469 mA	85	100uF
EC2SA05NH	5 VDC	±15 VDC	±67 mA	45 mA	462 mA	87	100uF
EC2SA06NH	5 VDC	±5 VDC	±200 mA	40 mA	482 mA	83	100uF
EC2SA11NH	12 VDC	5 VDC	400 mA	20 mA	203 mA	82	220uF
EC2SA12NH	12 VDC	12 VDC	167 mA	20 mA	192 mA	87	220uF
EC2SA13NH	12 VDC	15 VDC	134 mA	20 mA	193 mA	87	220uF
EC2SA14NH	12 VDC	±12 VDC	±83 mA	20 mA	193 mA	86	100uF
EC2SA15NH	12 VDC	±15 VDC	±67 mA	20 mA	193 mA	87	100uF
EC2SA16NH	12 VDC	±5 VDC	±200 mA	20 mA	198 mA	84	100uF
EC2SA21NH	24 VDC	5 VDC	400 mA	10 mA	102 mA	82	220uF
EC2SA22NH	24 VDC	12 VDC	167 mA	10 mA	96 mA	87	220uF
EC2SA23NH	24 VDC	15 VDC	134 mA	10 mA	95 mA	88	220uF
EC2SA24NH	24 VDC	±12 VDC	±83 mA	10 mA	96 mA	87	100uF
EC2SA25NH	24 VDC	±15 VDC	±67 mA	10 mA	95 mA	88	100uF
EC2SA26NH	24 VDC	±5 VDC	±200 mA	10 mA	100 mA	83	100uF

NOTE:
 1. Nominal Input Voltage 5, 12 or 24 VDC
 2. An External Input Capacitor 1uF tantalum for 24Vin Models are recommended to Reduce Input Ripple Voltage.

Derating Curve

Typical Derating Curve of Natural Convection

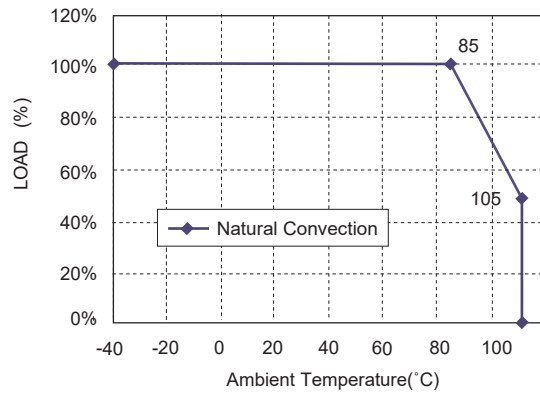

Specifications

All Specifications Typical At Nominal Line, Full Load, and 25°C Unless Otherwise Noted

INPUT SPECIFICATIONS

Input Voltage Range	±10%
Input Surge Voltage (100ms max.)	5V.....9Vdc max. 12V.....18Vdc max. 24V.....30Vdc max.
Input Filter (note5)	Capacitive

OUTPUT SPECIFICATIONS

Voltage Accuracy:	±3.0% max.
Voltage Balance (Dual Output)	±1.0% max.
Ripple and Noise, 20MHz BW (note 3)	200mV pk-pk max.
Temperature Coefficient	±0.05%/°C max.
Short Circuit Protection	Continuous, self-recovery
Line Regulation (note 1)	±1.2% max.
Load Regulation (note 2)	±10% max.

GENERAL SPECIFICATIONS

Efficiency	See Table
Isolation Voltage	3000VDC min.
Isolation Resistance	10 ⁹ ohm min.
Isolation Capacitance	18pF typ.
Switching Frequency	60KHz typ.
Operating Ambient Temperature Range	-40°C to +105°C
De-rating, Above 85°C	See Derating Curve
Case Temperature (note4)	+120°C max.
Cooling	Natural Convection
Storage Temperature Range	-55°C to +125°C
Humidity	95% RH max. Non condensing
MTBF MIL-HDBK-217F,GB	3.3Mhrs min.
Dimensions	0.77x0.28x0.40 inches (19.6x7.2x10.2 mm)
Case Material	Non-conductive black plastic
Weight	2.7g

NOTE

1. Line regulation is per 1.0% change in input voltage.
2. Load regulation is for load change from 100% to 20%.
3. The output noise is measured with 0.33uF ceramic capacitor.
4. Maximum case temperature under any operating condition should not be exceeded 120°C.
5. The EC2SA2XN input terminal need to parallel with 1uF tantalum capacitor.

EC3SA SERIES

3 WATT, 2:1 INPUT RANGE

Features

- ◆ 3W Isolated Output
- ◆ Compact SIP-8 Package
- ◆ Efficiency to 86%
- ◆ 2 : 1 Input Range
- ◆ Regulated Outputs
- ◆ Remote On/Off Control
- ◆ 1500VDC Isolation
- ◆ Continuous Short Circuit Protection
- ◆ Under Voltage Protection
- ◆ CE Mark Meets 2004/108/EC
- ◆ Safety Meets UL60950-1, EN60950-1, and IEC60950-1



Mechanical Dimensions

All Dimensions in Inches (mm)
 Tolerance Inches Millimeters
 X.XX±0.02 X.X±0.5
 Pin ±0.002 ±0.05

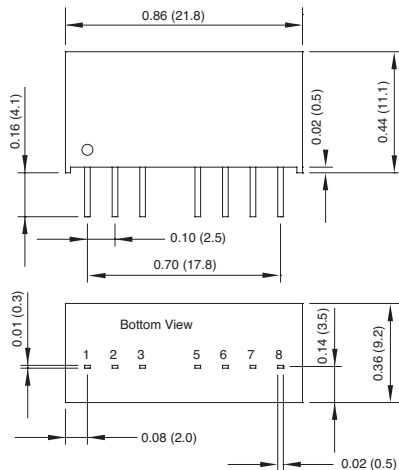

PIN CONNECTION		
PIN	Single Output	Dual Output
1	-V Input	-V Input
2	+V Input	+V Input
3	On/Off	On/Off
5	NC	NC
6	+V Output	+V Output
7	-V Output	Common
8	NC	-V Output

MODEL NUMBER	INPUT VOLTAGE	OUTPUT VOLTAGE	OUTPUT CURRENT		INPUT CURRENT		% EFF.	CAPACITOR LOAD MAX.
			MIN.	MAX.	NO LOAD	FULL LOAD		
EC3SA-05S33N	4.5-9.0 VDC	3.3 VDC	0 mA	700 mA	60 mA	632 mA	73	700µF
EC3SA-05S05N	4.5-9.0 VDC	5 VDC	0 mA	600 mA	60 mA	769 mA	78	600µF
EC3SA-05S12N	4.5-9.0 VDC	12 VDC	0 mA	250 mA	60 mA	759 mA	81	250µF
EC3SA-05S15N	4.5-9.0 VDC	15 VDC	0 mA	200 mA	60 mA	741 mA	81	200µF
EC3SA-05D05N	4.5-9.0 VDC	±5 VDC	±0 mA	±300 mA	60 mA	769 mA	78	300µF
EC3SA-05D12N	4.5-9.0 VDC	±12 VDC	±0 mA	±125 mA	60 mA	741 mA	81	125µF
EC3SA-05D15N	4.5-9.0 VDC	±15 VDC	±0 mA	±100 mA	60 mA	741 mA	81	100µF
EC3SA-12S33N	9-18 VDC	3.3 VDC	0 mA	700 mA	30 mA	253 mA	76	700µF
EC3SA-12S05N	9-18 VDC	5 VDC	0 mA	600 mA	30 mA	309 mA	81	600µF
EC3SA-12S12N	9-18 VDC	12 VDC	0 mA	250 mA	30 mA	301 mA	83	250µF
EC3SA-12S15N	9-18 VDC	15 VDC	0 mA	200 mA	30 mA	298 mA	84	200µF
EC3SA-12D05N	9-18 VDC	±5 VDC	±0 mA	±300 mA	30 mA	305 mA	82	300µF
EC3SA-12D12N	9-18 VDC	±12 VDC	±0 mA	±125 mA	30 mA	301 mA	83	125µF
EC3SA-12D15N	9-18 VDC	±15 VDC	±0 mA	±100 mA	30 mA	298 mA	84	100µF
EC3SA-24S33N	18-36 VDC	3.3 VDC	0 mA	700 mA	18 mA	125 mA	77	700µF
EC3SA-24S05N	18-36 VDC	5 VDC	0 mA	600 mA	18 mA	154 mA	81	600µF
EC3SA-24S12N	18-36 VDC	12 VDC	0 mA	250 mA	18 mA	149 mA	84	250µF
EC3SA-24S15N	18-36 VDC	15 VDC	0 mA	200 mA	18 mA	147 mA	85	200µF
EC3SA-24D05N	18-36 VDC	±5 VDC	±0 mA	±300 mA	18 mA	156 mA	80	300µF
EC3SA-24D12N	18-36 VDC	±12 VDC	±0 mA	±125 mA	18 mA	149 mA	84	125µF
EC3SA-24D15N	18-36 VDC	±15 VDC	±0 mA	±100 mA	18 mA	147 mA	85	100µF
EC3SA-48S33N	36-75 VDC	3.3 VDC	0 mA	700 mA	9 mA	63 mA	77	700µF
EC3SA-48S05N	36-75 VDC	5 VDC	0 mA	600 mA	9 mA	77 mA	81	600µF
EC3SA-48S12N	36-75 VDC	12 VDC	0 mA	250 mA	9 mA	73 mA	86	250µF
EC3SA-48S15N	36-75 VDC	15 VDC	0 mA	200 mA	9 mA	73 mA	86	200µF
EC3SA-48D05N	36-75 VDC	±5 VDC	±0 mA	±300 mA	9 mA	77 mA	81	300µF
EC3SA-48D12N	36-75 VDC	±12 VDC	±0 mA	±125 mA	9 mA	73 mA	86	125µF
EC3SA-48D15N	36-75 VDC	±15 VDC	±0 mA	±100 mA	9 mA	73 mA	86	100µF

Derating Curve

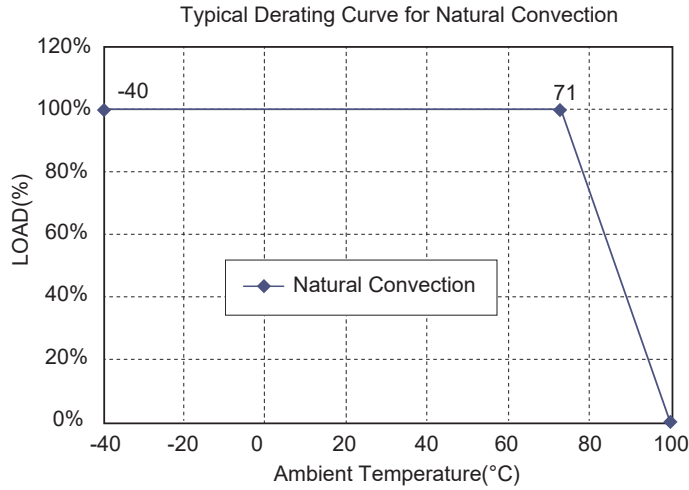

Specification

All Specifications Typical At Nominal Line, Full Load, and 25°C Unless Otherwise Noted

INPUT SPECIFICATIONS

Input Voltage Range	5V4.5-9V
	12V9-18V
	24V18-36V
	48V36-75V
Input Surge Voltage (100ms max.)	5V15Vdc max.
	12V25Vdc max.
	24V50Vdc max.
	48V100Vdc max.
Under Voltage Protection (note 5):	
5Vin	Power Up.....4.2Vdc max. Power Down.....3Vdc min.
12Vin	Power Up.....7.3Vdc max. Power Down.....5.8Vdc min.
24Vin	Power Up.....15.5Vdc max. Power Down.....12Vdc min.
48Vin	Power Up.....31Vdc max. Power Down.....24Vdc min.
Input Filter	Capacitive
Remote On/Off control (note 6):	
Module Off (input idle current)	1mA max.

OUTPUT SPECIFICATIONS

Voltage Accuracy	±1.5% max.
Voltage Balance (Dual)	±1.0% max.
Cross regulation (Dual) (note 1)	
Asymmetrical load 25%/100%	±5.0% max.
Transient Response: 25% Step Load Change	
Error Band	±6% Vout nominal
Recovery Time	< 500µs
Ripple & Noise 20MHz BW	75mV pk-pk max.
Temperature Coefficient	±0.03%/°C
Line Regulation (note 2)	±0.5% max.
Load Regulation (note 3)	±0.5% max.
	±1.0% max.
Output Short Circuit Protection	Continuous
Start up time	1ms typ.

GENERAL SPECIFICATIONS

Efficiency	See Table
Isolation Voltage	1500VDC min.
Isolation Resistance	10 ⁹ ohm min.
Isolation Capacitance	500pF typ.
Switching Frequency	100KHz min.
Operating Ambient Temperature	-40°C to +85°C
De-rating, Above 71°C	Linearly to Zero power at 100°C
Case Temperature (note 4)	100°C max.
Cooling	Natural Convection
Storage Temperature	-55°C to +125°C
Humidity	95% RH max. Non condensing
MTBF MIL-STD-217F, GB, 25°C, Full Load	2500khrs typ.
Dimensions	0.86 x 0.36 x 0.44 inches (21.8 x 9.2 x 11.1 mm)
Case Material	Non-Conductive Black Plastic
Weight	4.8 g

NOTE

- For asymmetric loading both channels must be at 25% load or more.
- Measured from high line to low line.
- Measured from full load to 10% load.
- Maximum case temperature under any operating condition should not be exceeded 100°C.
- Suffix "N" to the model with under voltage protection.
- Suffix "N" Models: Module On 0 to < 0.8VDC or open circuit
Module Off 4 to 15VDC
Other Models: Module On 0 to < 1.2VDC or open circuit
Module Off 5.5 to 15VDC

EC3SAW SERIES

3 WATT, 4:1 INPUT RANGE

Features

- ◆ 3W Isolated Output
- ◆ Compact SIP-8 Package
- ◆ Efficiency to 85%
- ◆ 4 : 1 Input Range
- ◆ Regulated Outputs
- ◆ Remote On/Off Control
- ◆ 1500VDC Isolation
- ◆ Continuous Short Circuit Protection
- ◆ Input Under Voltage Protection
- ◆ No Tantalum Capacitor Inside
- ◆ CE Mark Meets 2014/30/EU
- ◆ Safety Meets UL60950-1, EN60950-1, and IEC60950-1



Mechanical Dimensions

All Dimensions In Inches (mm)
 Tolerance Inches Millimeters
 X.XX±0.02 X.X±0.5
 Pin ±0.002 ±0.05

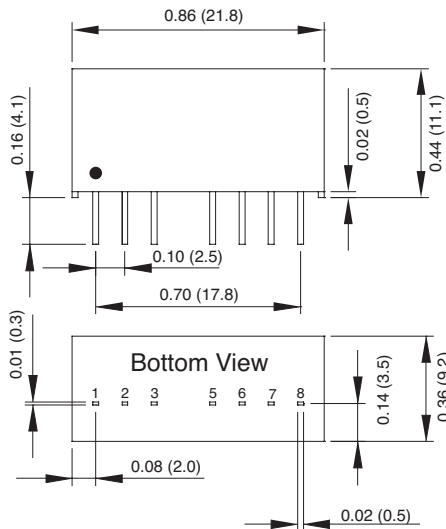

PIN CONNECTION		
PIN	Single	Dual
1	-Vin	-Vin
2	+Vin	+Vin
3	On/Off	On/Off
5	NC	NC
6	+Vo	+Vo
7	-Vo	Common
8	NC	-Vo

MODEL NUMBER	INPUT VOLTAGE	OUTPUT VOLTAGE	OUTPUT CURRENT		INPUT CURRENT		% EFF.	CAPACITOR LOAD MAX.
			MIN.	MAX.	NO LOAD	FULL LOAD		
EC3SAW-24S33P	9-36 VDC	3.3 VDC	0 mA	700 mA	4 mA	122 mA	79	1800µF
EC3SAW-24S05P	9-36 VDC	5 VDC	0 mA	600 mA	4 mA	154 mA	81	1000µF
EC3SAW-24S12P	9-36 VDC	12 VDC	0 mA	250 mA	8 mA	150 mA	84	220µF
EC3SAW-24S15P	9-36 VDC	15 VDC	0 mA	200 mA	12 mA	150 mA	84	120µF
EC3SAW-24D05P	9-36 VDC	±5 VDC	0 mA	±300 mA	8 mA	154 mA	81	470µF
EC3SAW-24D12P	9-36 VDC	±12 VDC	0 mA	±125 mA	12 mA	150 mA	84	100µF
EC3SAW-24D15P	9-36 VDC	±15 VDC	0 mA	±100 mA	12 mA	151 mA	83	47µF
EC3SAW-48S33P	18-75 VDC	3.3 VDC	0 mA	700 mA	3 mA	61 mA	79	1800µF
EC3SAW-48S05P	18-75 VDC	5 VDC	0 mA	600 mA	3 mA	76 mA	82	1000µF
EC3SAW-48S12P	18-75 VDC	12 VDC	0 mA	250 mA	5 mA	74 mA	85	220µF
EC3SAW-48S15P	18-75 VDC	15 VDC	0 mA	200 mA	5 mA	75 mA	84	120µF
EC3SAW-48D05P	18-75 VDC	±5 VDC	0 mA	±300 mA	5 mA	76 mA	82	470µF
EC3SAW-48D12P	18-75 VDC	±12 VDC	0 mA	±125 mA	10 mA	75 mA	84	100µF
EC3SAW-48D15P	18-75 VDC	±15 VDC	0 mA	±100 mA	10 mA	75 mA	83	47µF

NOTE: 1. Nominal Input Voltage 24 or 48VDC

Derating Curve

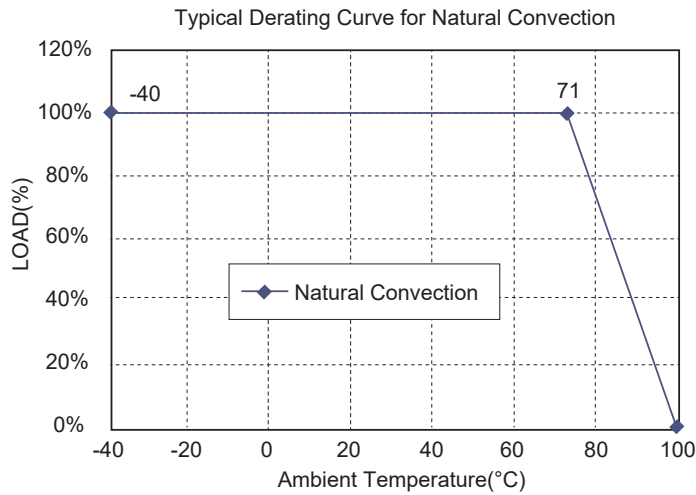

Specification

All Specifications Typical At Nominal Line, Full Load, and 25°C Unless Otherwise Noted

INPUT SPECIFICATIONS

Input Voltage Range	24VDC 9-36VDC	48VDC 18-75VDC
Input Surge Voltage (100ms max.)	24VDC 50VDC max.	48VDC 100VDC max.
Under Voltage Protection:		
24Vin	Power Up.....7.5 VDC max.	Power Down6 VDC min.
48Vin	Power Up15.5 VDC max.	Power Down12 VDC min.
Input Filter	Capacitive	
Remote On/Off Control: (Referenced to -Vin)		
Module On	Open Circuit	
Module Off	0 to < 1.2VDC	
Module Off (Input Idle Current)	1mA max.	

OUTPUT SPECIFICATIONS

Voltage Accuracy	±1.5% max.
Voltage Balance (Dual)	±1.0% max.
Cross Regulation (Dual)(note 4)	
Asymmetrical Load 25%/100%	±5.0% max.
Transient Response: 25% Step Load Change	
Error Band	±6% Vout nominal
Recovery Time	< 500µs
Ripple & Noise, 20MHz BW	50mV pk-pk max.
Temperature Coefficient	±0.03%/°C
Line Regulation (note 1)	±0.5% max.
Load Regulation (note 2)	
Single	±0.5% max.
Dual	±1.0% max.
Output Short Circuit Protection	Continuous
Start Up Time	5ms max.

GENERAL SPECIFICATIONS

Efficiency	See Table	
Isolation Voltage	1500VDC min.	
Isolation Resistance	10 ⁹ ohm min.	
Isolation Capacitance	500pF typ.	
Switching Frequency	100KHz min.	
Operating Ambient Temperature	-40°C to +85°C	
De-rating, Above 71°C	Linearly to Zero Power at 100°C	
Case Temperature (note 3)	100°C max.	
Cooling	Natural Convection	
Storage Temperature	-55°C to +125°C	
Humidity	95% RH max. Non-Condensing	
MTBFMIL-HDBK-217F, GB, 25°C, Full Load		
	Single	2800Khrs typ.
	Dual	2100Khrs typ.
EMI	Conductive EMI Meets EN55022 Class A & Class B (note 5)	
Dimensions	0.86 x 0.36 x 0.44 inches (21.8 x 9.2 x 11.1 mm)	
Case Material	Non-Conductive Black Plastic	
Weight	4.8 g	

NOTE

1. Measured from high line to low line.
2. Measured from full load to 10% load.
3. Maximum case temperature under any operating condition should not be exceeded 100°C.
4. For asymmetric loading both channels must be at 25% load or more.
5. The EC3SAW series meet EN55022 Class A & Class B with external C-L filter before the input pins to the converter. (see application note)

EC4SAW SERIES

5-6 WATT, 4:1 INPUT RANGE

Feature

- ◆ 5-6W Isolated Output
- ◆ Compact SIP-8 Package
- ◆ Efficiency to 89%
- ◆ 4 : 1 Input Range
- ◆ Regulated Outputs
- ◆ Remote On/Off Control
- ◆ 1500VDC Isolation
- ◆ Continuous Short Circuit Protection



Mechanical Dimensions

All Dimensions In Inches (mm)

Tolerance	Inches	Millimeters
	X.XX±0.02	X.X±0.5
Pin	±0.002	±0.05

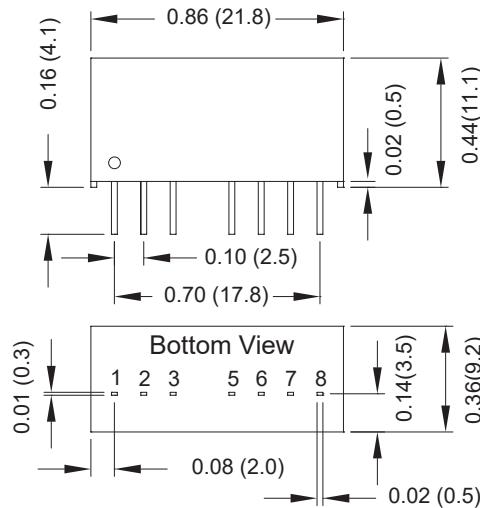

PIN CONNECTION		
PIN	Single Output	Dual Output
1	-V Input	-V Input
2	+V Input	+V Input
3	On/Off	On/Off
5	NC	NC
6	+V Output	+V Output
7	-V Output	Common
8	NC	-V Output

MODEL NUMBER	INPUT VOLTAGE	OUTPUT VOLTAGE	OUTPUT CURRENT		INPUT CURRENT		% EFF.		CAPACITOR LOAD MAX.
			MIN.	MAX.	NO LOAD	FULL LOAD	(3)	(2)	
EC4SAW-24S33N	9-36 VDC	3.3 VDC	0 mA	1500 mA	4 mA	310 mA	82	82	4700µF
EC4SAW-24S05N	9-36 VDC	5 VDC	0 mA	1200 mA	4 mA	298 mA	86	86	2200µF
EC4SAW-24S12N	9-36 VDC	12 VDC	0 mA	500 mA	5 mA	288 mA	88	88	1100µF
EC4SAW-24S15N	9-36 VDC	15 VDC	0 mA	400 mA	5 mA	288 mA	89	88	470µF
EC4SAW-24D05N	9-36 VDC	±5 VDC	0 mA	±600 mA	4 mA	298 mA	86	86	1400µF
EC4SAW-24D12N	9-36 VDC	±12 VDC	0 mA	±250 mA	6 mA	288 mA	88	88	660µF
EC4SAW-24D15N	9-36 VDC	±15 VDC	0 mA	±200 mA	6 mA	288 mA	88	88	220µF
EC4SAW-48S33N	18-75 VDC	3.3 VDC	0 mA	1500 mA	3 mA	155 mA	82	82	4700µF
EC4SAW-48S05N	18-75 VDC	5 VDC	0 mA	1200 mA	3 mA	150 mA	85	85	2200µF
EC4SAW-48S12N	18-75 VDC	12 VDC	0 mA	500 mA	3 mA	145 mA	88	89	1100µF
EC4SAW-48S15N	18-75 VDC	15 VDC	0 mA	400 mA	3 mA	145 mA	89	88	470µF
EC4SAW-48D05N	18-75 VDC	±5 VDC	0 mA	±600 mA	4 mA	150 mA	85	85	1400µF
EC4SAW-48D12N	18-75 VDC	±12 VDC	0 mA	±250 mA	3 mA	145 mA	88	89	660µF
EC4SAW-48D15N	18-75 VDC	±15 VDC	0 mA	±200 mA	3 mA	145 mA	88	89	220µF

NOTE:

1. Nominal Input Voltage 24 or 48 VDC
2. Measured at Nominal Input Voltage
3. Measured at 12VDC for 24Vin, 24VDC for 48Vin

Derating Curve

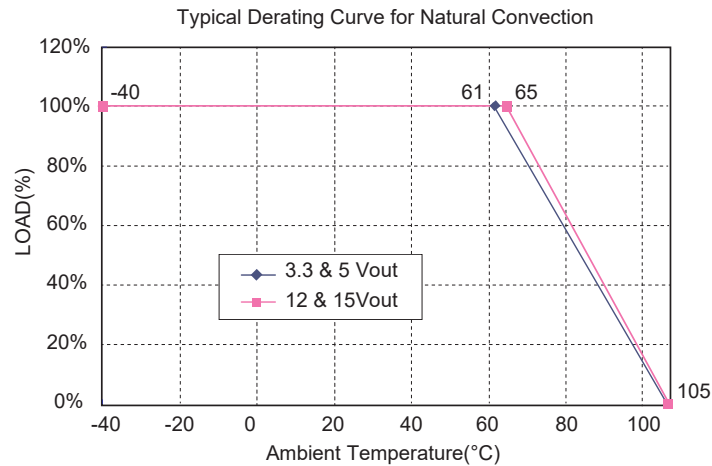

Specification

All Specifications Typical At Nominal Line, Full Load, and 25°C Unless Otherwise Noted

INPUT SPECIFICATIONS

Input Voltage Range	24V 9-36V
	48V 18-75V
Input Surge Voltage (100 ms max.)	24V 50VDC max.
	48V 100VDC max.
Input Filter	Capacitive
Remote On/Off control:	
Module On	Open or high impedance
Module Off	2mA to 4mA
Module Off (input idle current)	2.5mA max.

OUTPUT SPECIFICATIONS

Voltage Accuracy	±1.5% max.
Voltage Balance (Dual)	±1.0% max
Transient Response: 25% Step Load Change	
Error Band	±5% Vout nominal
Recovery Time	< 250µs
Ripple & Noise, 20MHz BW	100mV pk-pk max.
Temperature Coefficient	±0.03%/°C
Short Circuit Protection	Continuous
Line Regulation (note 1)	±0.2% max.
Load Regulation (note 2)	±0.5% max.
	Single
	Dual
	±1.0% max.
Cross regulation (Dual note 3)	
Asymmetrical load 25%/100%	±5.0% max.
Current Limit	180% typ.
Start up time	15ms typ.

GENERAL SPECIFICATIONS

Efficiency	See Table
Isolation Voltage	1500VDC min.
Isolation Resistance	10 ⁹ ohm min.
Isolation Capacitance	50pF max.
Switching Frequency	580KHz typ.
Operating Ambient Temperature	-40°C to +85°C
De-rating, Above 61°C.....	3.3V/5V
De-rating, Above 65°C.....	12V/15V
Case Temperature (note 3)	
Cooling	Natural Convection
Storage Temperature	-55°C to +125°C
Humidity	95% RH max. Non condensing
MTBF.....MIL-HDBK-217F, GB, 25°C, Full Load	1850Khrs typ.
Dimensions	0.86 x 0.36 x 0.44 inches (21.8 x 9.2 x 11.1 mm)
Case Material	Non-Conductive Black Plastic
Weight	4.8 g

NOTE

1. Measured from high line to low line.
2. Measured from full load to no load.
3. For asymmetric loading, both channels must be at 25% load or more.
4. Maximum case temperature under any operating condition should not be exceeded 105°C.

EC5SAW SERIES

6.6-10 WATT WIDE INPUT DC-DC CONVERTERS

Features

- ◆ 6.6-10W Isolated Output
- ◆ Compact SIP8 Package
- ◆ Low No Load Power Consumption
- ◆ Input under-voltage Protection
- ◆ Efficiency Up to 89%
- ◆ 4:1 Input Range
- ◆ Regulated Outputs
- ◆ Fixed Switching Frequency
- ◆ Remote On/Off Control
- ◆ No Tantalum Capacitor Inside
- ◆ 3000VDC Isolation
- ◆ Continuous Short Circuit Protection

Preliminary



Mechanical Dimensions

All Dimensions In Inches (mm)
 Tolerances : Inches Millimeters
 X.XX=±0.02 X. X=±0.5
 Pin ±0.002 ±0.05

PIN CONNECTION		
PIN	Single	Dual
1	-V Input	-V Input
2	+V Input	+V Input
3	On/Off	On/Off
6	+V Output	+V Output
7	-V Output	Common
8	NC	-V Output

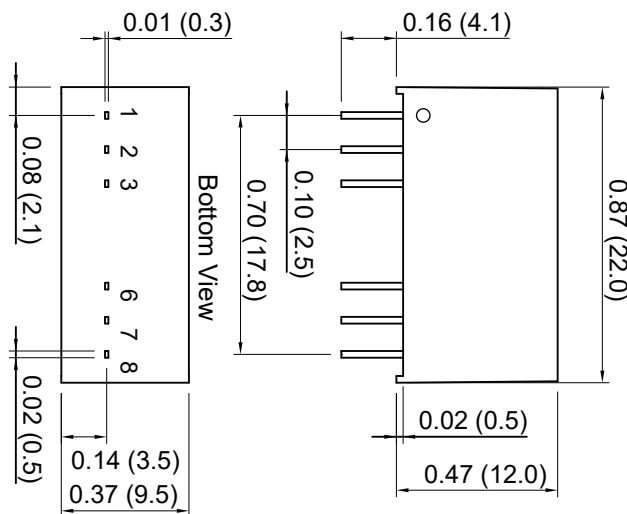

MODEL NUMBER	INPUT VOLTAGE(4)	OUTPUT VOLTAGE	OUTPUT CURRENT		INPUT CURRENT		% EFF.		CAPACITOR LOAD MAX.
			MIN.	MAX.	NO LOAD	FULL LOAD	(3)	(2)	
EC5SAW-24S33N	9-36 VDC	3.3 VDC	0 mA	2000 mA	5 mA	336 mA	81	82	2000uF
EC5SAW-24S05N	9-36 VDC	5 VDC	0 mA	2000 mA	5 mA	490 mA	84	85	2000uF
EC5SAW-24S12N	9-36 VDC	12 VDC	0 mA	833 mA	5 mA	473 mA	87	88	833uF
EC5SAW-24S15N	9-36 VDC	15 VDC	0 mA	666 mA	5 mA	468 mA	88	89	666uF
EC5SAW-24D05N	9-36 VDC	±5 VDC	0 mA	±1000 mA	5 mA	490 mA	84	85	1000uF
EC5SAW-24D12N	9-36 VDC	±12 VDC	0 mA	±417 mA	5 mA	468 mA	88	89	417uF
EC5SAW-24D15N	9-36 VDC	±15 VDC	0 mA	±333 mA	5 mA	468 mA	88	89	333uF
EC5SAW-48S33N	18-75 VDC	3.3 VDC	0 mA	2000 mA	5 mA	168 mA	81	82	2000uF
EC5SAW-48S05N	18-75 VDC	5 VDC	0 mA	2000 mA	5 mA	245 mA	84	85	2000uF
EC5SAW-48S12N	18-75 VDC	12 VDC	0 mA	833 mA	5 mA	237 mA	87	88	833uF
EC5SAW-48S15N	18-75 VDC	15 VDC	0 mA	666 mA	5 mA	234 mA	88	89	666uF
EC5SAW-48D05N	18-75 VDC	±5 VDC	0 mA	±1000 mA	5 mA	245 mA	84	85	1000uF
EC5SAW-48D12N	18-75 VDC	±12 VDC	0 mA	±417 mA	5 mA	234 mA	88	89	417uF
EC5SAW-48D15N	18-75 VDC	±15 VDC	0 mA	±333 mA	5 mA	234 mA	88	89	333uF

NOTE:
 1. Nominal Input Voltage 24 or 48 VDC
 2. Measured at Nominal Input Voltage
 3. Measured at 12VDC for 24Vin, 24VDC for 48Vin
 4. For 3.3Vo, 5Vo & ±5Vo has derating by input is required show Fig.1

Derating Curve

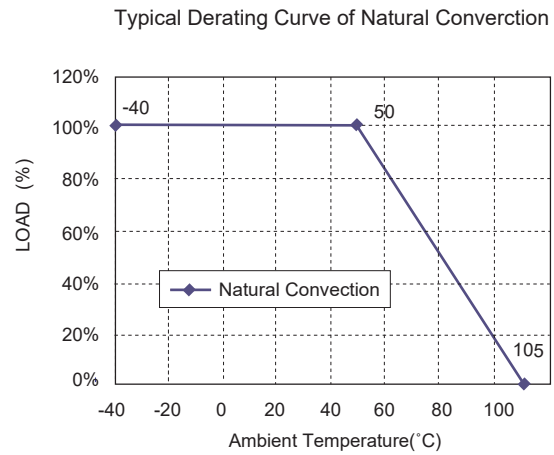
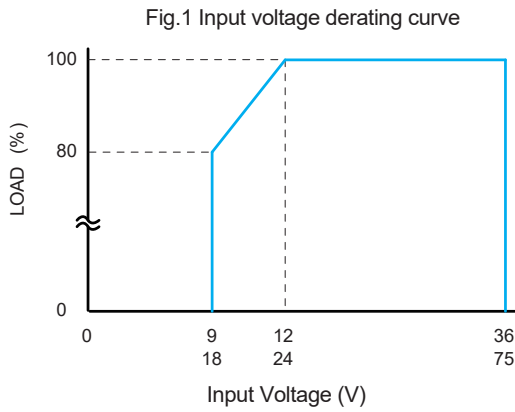

Specifications

All Specifications Typical At Nominal Line, Full Load, and 25°C Unless Otherwise Noted

INPUT SPECIFICATIONS

Input Voltage Range	24V.....9-36V 48V.....18-75V
Input Surge Voltage (100ms max.)	24V.....50VDC max. 48V.....100VDC max.
Input Filter	Capacitive
Remote On/Off control:	
Module On	Open or high impedance
Module Off	2mA to 4mA
Module Off (input idle current)	2.5mA max.

OUTPUT SPECIFICATIONS

Voltage Accuracy:	±1.0% max.
Voltage Balance (Dual)	±1.0% max.
Transient Response: 75%~100% Step Load Change	
Error Band	±5% Vout nominal
Recovery Time	< 250µs
Ripple & Noise, 20MHz BW (Note 5)	
3.3V & 5V & ±5V	100mV pk-pk max.
12V & 15V & ±12V & ±15V	1%Vo max.
Temperature Coefficient	±0.02%/°C
Short Circuit Protection	Continuous
Line Regulation (note 1)	±0.2% max.
Load Regulation (note 2)	±1.0% max.
Cross regulation(Dual note3)	
Asymmetrical load 25%/100%	±5.0% max.
Current Limit	180% typ.
Start up time	TBD

GENERAL SPECIFICATIONS

Efficiency	See Table
Isolation Voltage	3000VDC min.
Isolation Resistance	10 ⁹ ohm min.
Isolation Capacitance	TBD
Switching Frequency	530KHz typ.
Operating Ambient Temperature	-40°C to +85°C
De-rating, Above 50°C	Linearly to Zero power at 105°C
Case Temperature (note4)	105°C max.
Cooling	Natural Convection
Storage Temperature	-55°C to +125°C
Humidity	95% RH max. Non condensing
MTBF MIL-HDBK-217F, GB, 25°C, Full Load	TBD
Dimensions	0.87x0.37x0.47 inches (22x9.5x12 mm)
Case Material	Non-Conductive Black Plastic
Weight	TBD

NOTE

1. Measured from high line to low line.
2. Measured from full load to no load.
3. For asymmetric loading, both channels must be at 25% load or more.
4. Maximum case temperature under any operating condition should not be exceeded 105°C.
5. Output ripple and noise measured with 1µF ceramic capacitor

EC2A SERIES

1.5 WATT

Features

- ◆ 1.5W Output Power
- ◆ DIP-24/SMD Package
- ◆ Efficiency to 50%
- ◆ Regulated Outputs
- ◆ PI Input Filter
- ◆ Low Ripple and Noise

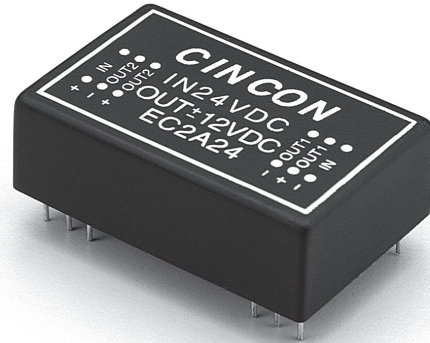

Mechanical Dimensions

NOTE: Pin Size is 0.02" Inch (0.5mm) DIA±0.05
 All Dimensions in Inches (mm)
 Tolerance Inches: X.XX=±0.02, X.XXX=±0.010
 Millimeters: X.X=±0.5, X.XX=±0.25

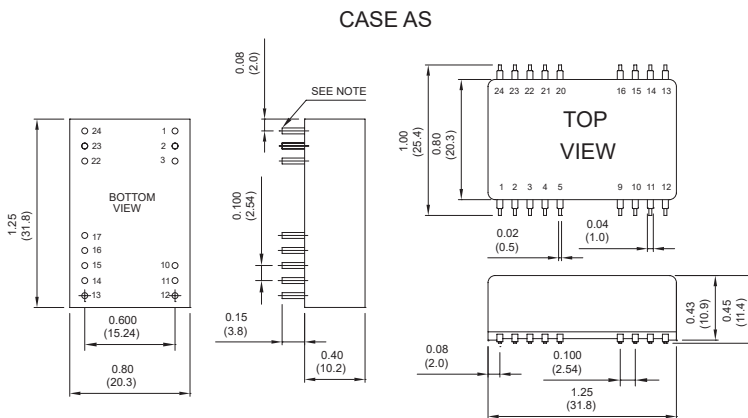

PIN CONNECTION									
Pin	500 VDC				1.5K & 3K VDC				
	Single Output	Dual Output		Pin	Single Output	Dual Output			
	DIP	SMD	DIP	SMD	DIP	SMD	DIP	SMD	
1,24	+V Input		+V Input		1,2,3	+V Input		+V Input	
2,23	NC		-V Output		22,23,24	-V Input		-V Input	
3,22	NC		Common		4	NP	NC	NP	NC
4,5	NP	NC	NP	NC	5	NP	NC	NP	NC
9	NP	NC	NP	NC	9	NP	NC	NP	NC
10	-V Output		Common		10,11	NP	NC	Common	
11	+V Output		+V Output		12	-V Output		-TP	
12,13	-V Input		-V Input		13	+V Output		-V Output	
14	+V Output		+V Output		14	NP	NC	NP	NC
15	-V Output		Common		15	NP	NC	+V Output	
16	NP	NC	NP	NC	16	NP	NC	+TP	
17	NP		NP		17	+TP	NP	NP	
20,21	NP	NC	NP	NC	20,21	NP	NC	NP	NC

* NP-NO PIN
 * NC-NO CONNECTION WITH PIN
 * TP-TEST POINT

MODEL NUMBER	INPUT VOLTAGE	OUTPUT VOLTAGE	OUTPUT CURRENT	INPUT CURRENT		CASE
				NO LOAD	FULL LOAD	
EC2A01	5 VDC	5 VDC	300 mA	110 mA	620 mA	DIP-24
EC2A02	5 VDC	12 VDC	125 mA	110 mA	550 mA	DIP-24
EC2A03	5 VDC	15 VDC	100 mA	110 mA	550 mA	DIP-24
EC2A04	5 VDC	±12 VDC	±60 mA	110 mA	550 mA	DIP-24
EC2A05	5 VDC	±15 VDC	±50 mA	110 mA	550 mA	DIP-24
EC2A11	12 VDC	5 VDC	300 mA	40 mA	260 mA	DIP-24
EC2A12	12 VDC	12 VDC	125 mA	40 mA	215 mA	DIP-24
EC2A13	12 VDC	15 VDC	100 mA	40 mA	215 mA	DIP-24
EC2A14	12 VDC	±12 VDC	±60 mA	40 mA	215 mA	DIP-24
EC2A15	12 VDC	±15 VDC	±50 mA	40 mA	215 mA	DIP-24
EC2A21	24 VDC	5 VDC	300 mA	20 mA	130 mA	DIP-24
EC2A22	24 VDC	12 VDC	125 mA	20 mA	115 mA	DIP-24
EC2A23	24 VDC	15 VDC	100 mA	20 mA	115 mA	DIP-24
EC2A24	24 VDC	±12 VDC	±60 mA	20 mA	115 mA	DIP-24
EC2A25	24 VDC	±15 VDC	±50 mA	20 mA	115 mA	DIP-24
EC2A31	28 VDC	5 VDC	300 mA	20 mA	110 mA	DIP-24
EC2A32	28 VDC	1 2VDC	125 mA	20 mA	100 mA	DIP-24
EC2A33	28 VDC	15 VDC	100 mA	20 mA	100 mA	DIP-24
EC2A34	28 VDC	±12 VDC	±60 mA	20 mA	100 mA	DIP-24
EC2A35	28 VDC	±15 VDC	±50 mA	20 mA	100 mA	DIP-24
EC2A41	48 VDC	5 VDC	300 mA	15 mA	65 mA	DIP-24
EC2A42	48 VDC	12 VDC	125 mA	15 mA	60 mA	DIP-24
EC2A43	48 VDC	15 VDC	100 mA	15 mA	60 mA	DIP-24
EC2A44	48 VDC	±12 VDC	±60 mA	15 mA	60 mA	DIP-24
EC2A45	48 VDC	±15 VDC	±50 mA	15 mA	60 mA	DIP-24

Derating Curve

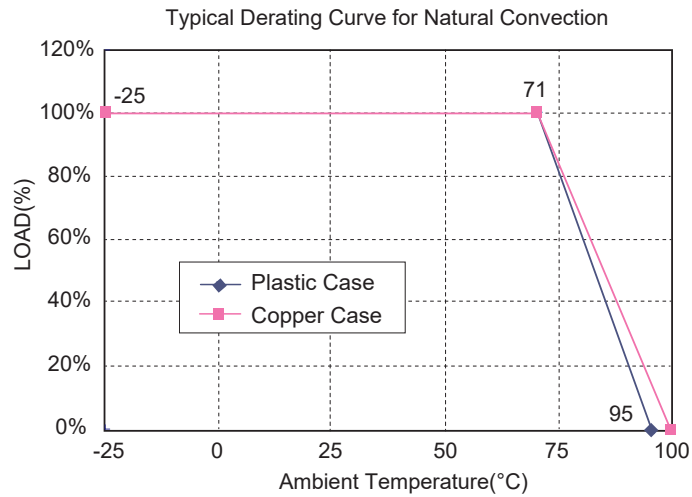

Specification

All Specifications Typical At Nominal Line, Full Load, and 25°C Unless Otherwise Noted

INPUT SPECIFICATIONS

Input Voltage Range	±10%
Input Filter	PI Type

ISOLATION VOLTAGE

500 VDC min.	Standard Models
3KVDC min.	Suffix "H" Models
1.5KVDC min.	Suffix "HM" Models

OUTPUT SPECIFICATIONS

Voltage Accuracy	±4.0% max.
Temperature coefficient	±0.02%/°C
Ripple & Noise, 20MHz BW	50mV pk-pk max.
Short Circuit Protection	Momentary
Line Regulation	±0.3%
Load Regulation	±0.5%

CASE MATERIAL

Standard Models	Non-Conductive Black Plastic
Suffix "M" Models	Black Coated Copper with Non-Conductive Base

NOTE

- Suffix "S" to the model number with SMD packages.
- Maximum case temperature under any operating condition should not be exceeded 95°C (Plastic Case), 100°C (Copper Case).

GENERAL SPECIFICATIONS

Efficiency	50%
Isolation Capacitance	30pF
Isolation Resistance	10 ⁹ ohm
Switching Frequency	20KHz min.
Operating Ambient Temperature Range	-25°C to +71°C
De-rating, Above 71°C (Plastic Case)	Linearly to Zero power at 95°C
De-rating, Above 71°C (Copper Case)	Linearly to Zero power at 100°C
Case Temperature (Plastic case note 2)	95°C max.
(Copper case note 2)	100°C max.
Cooling	Natural Convection
Storage Temperature Range	-40°C to +100°C
Dimensions	DIP
	1.25 × 0.80 × 0.40 inches (31.8 × 20.3 × 10.2 mm)
	SMD
	1.25 × 0.80 × 0.45 inches (31.8 × 20.3 × 11.4 mm)
Weight	12.5 g

EC3A SERIES

3 WATT, 2:1 INPUT RANGE

Features

- ◆ 3W Isolated Output
- ◆ 24-Pin DIP Package
- ◆ Efficiency to 82%
- ◆ 2 : 1 Input Range
- ◆ Regulated Outputs
- ◆ Pi Input Filter
- ◆ Continuous Short Circuit Protection
- ◆ UL60950-1 Approval for H/HM Versions only

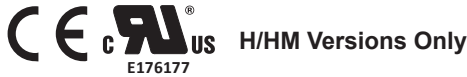
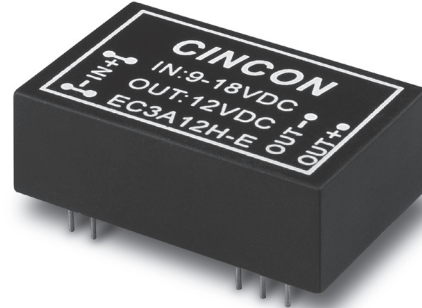

Mechanical Dimensions

NOTE: Pin Size is 0.02" Inch (0.5mm) DIA
 All Dimensions in Inches (mm)
 Tolerance Inches: X.XX±0.02, X.XXX±0.010
 Millimeters: X.X±0.5, X.XX±0.25

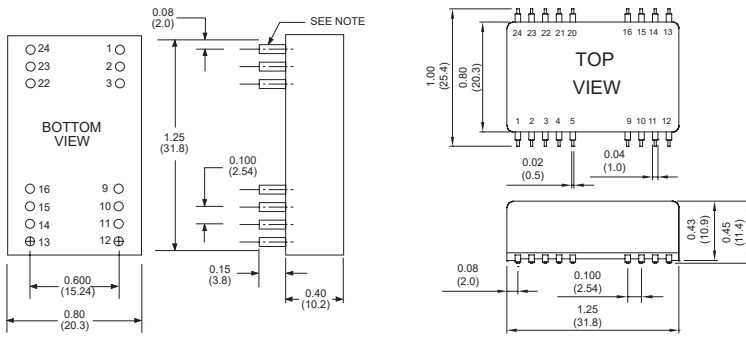

PIN CONNECTION									
Pin	500 VDC				1.5K & 3K VDC				
	Single Output		Dual Output		Pin	Single Output		Dual Output	
	DIP	SMD	DIP	SMD		DIP	SMD	DIP	SMD
1,24	+V Input		+V Input		1,24	NP	NC	NP	NC
2,23	NC		-V Output		2,3	-V Input		-V Input	
3,22	NC		Common		4,5	NP	NC	NP	NC
4	NP	NC	NP	NC	9	NC		Common	
5	NP	NC	NP	NC	10,15	NC		NC	
9	NP	NC	NP	NC	11	NC		-V Output	
10,15	-V Output		Common		12,13	NP	NC	NP	NC
11,14	+V Output		+V Output		14	+V Output		+V Output	
12,13	-V Input		-V Input		16	-V Output		Common	
16	NP	NC	NP	NC	20,21	NP	NC	NP	NC
20,21	NP	NC	NP	NC	22,23	+V Input		+V Input	

* NP-NO PIN
 * NC-NO CONNECTION WITH PIN

MODEL NUMBER	INPUT VOLTAGE	OUTPUT VOLTAGE	OUTPUT CURRENT	INPUT CURRENT		% EFF.	CAPACITOR LOAD MAX.
				NO LOAD	FULL LOAD		
EC3A01	4.5-6 VDC	5 VDC	600 mA	15 mA	800 mA	75	2200µF
EC3A02	4.5-6 VDC	12 VDC	250 mA	15 mA	759 mA	79	2200µF
EC3A03	4.5-6 VDC	15 VDC	200 mA	15 mA	779 mA	77	2200µF
EC3A04	4.5-6 VDC	±5 VDC	±300 mA	25 mA	779 mA	77	1000µF
EC3A05	4.5-6 VDC	±12 VDC	±125 mA	25 mA	789 mA	76	1000µF
EC3A06	4.5-6 VDC	±15 VDC	±100 mA	25 mA	800 mA	75	1000µF
EC3A07	4.5-6 VDC	3.3 VDC	600 mA	15 mA	582 mA	68	2200µF
EC3A11	9-18 VDC	5 VDC	600 mA	7.5 mA	325 mA	77	2200µF
EC3A12	9-18 VDC	12 VDC	250 mA	7.5 mA	313 mA	80	2200µF
EC3A13	9-18 VDC	15 VDC	200 mA	7.5 mA	316 mA	79	2200µF
EC3A14	9-18 VDC	±5 VDC	±300 mA	12 mA	325 mA	77	1000µF
EC3A15	9-18 VDC	±12 VDC	±125 mA	12 mA	325 mA	77	1000µF
EC3A16	9-18 VDC	±15 VDC	±100 mA	12 mA	316 mA	79	1000µF
EC3A17	9-18 VDC	3.3 VDC	600 mA	7.5 mA	229 mA	72	2200µF
EC3A21	18-36 VDC	5 VDC	600 mA	5 mA	158 mA	79	2200µF
EC3A22	18-36 VDC	12 VDC	250 mA	5 mA	156 mA	80	2200µF
EC3A23	18-36 VDC	15 VDC	200 mA	5 mA	152 mA	82	2200µF
EC3A24	18-36 VDC	±5 VDC	±300 mA	7.5 mA	162 mA	77	1000µF
EC3A25	18-36 VDC	±12 VDC	±125 mA	7.5 mA	158 mA	79	1000µF
EC3A26	18-36 VDC	±15 VDC	±100 mA	7.5 mA	154 mA	81	1000µF
EC3A27	18-36 VDC	3.3 VDC	600 mA	5 mA	111 mA	74	2200µF
EC3A31	36-72 VDC	5 VDC	600 mA	2 mA	78 mA	79	2200µF
EC3A32	36-72 VDC	12 VDC	250 mA	2 mA	78 mA	80	2200µF
EC3A33	36-72 VDC	15 VDC	200 mA	2 mA	78 mA	80	2200µF
EC3A34	36-72 VDC	±5 VDC	±300 mA	3 mA	80 mA	78	1000µF
EC3A35	36-72 VDC	±12 VDC	±125 mA	3 mA	80 mA	78	1000µF
EC3A36	36-72 VDC	±15 VDC	±100 mA	3 mA	80 mA	78	1000µF
EC3A37	36-72 VDC	3.3 VDC	600 mA	3 mA	57 mA	72	2200µF

NOTE:
 1. Nominal input voltage is 5, 12, 24 or 48VDC.
 2. Typical value at nominal input voltage and full load.

Derating Curve

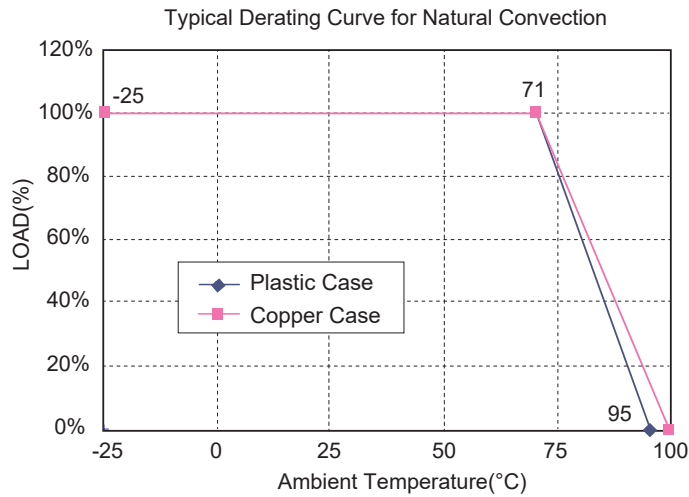

Specification

All Specifications Typical At Nominal Line, Full Load, and 25°C Unless Otherwise Noted

INPUT SPECIFICATIONS

Input Voltage Range	5V4.5-6V
	12V 9-18V
	24V 18-36V
	48V 36-72V
Input Surge Voltage (100ms max.)	5V 10Vdc max.
	12V 25Vdc max.
	24V 50Vdc max.
	48V 100Vdc max.
Input Filter	Pi Type

OUTPUT SPECIFICATIONS

Voltage Accuracy	±2.0% max.
Voltage Balance (Dual)	±1.0% max.
Temperature Coefficient	±0.05%/°C
Ripple & Noise, 20MHz BW	3.3V/5V ..100mV pk-pk, max.
	12V/15V1% pk-pk max.
Short Circuit Protection	Continuous
Line Regulation	Single/Dual (note 1) ±0.5% max.
Load Regulation	Single (note 2) ±0.5% max.
	Dual (note 3) ±1.0% max.

GENERAL SPECIFICATIONS

Efficiency	See Table
Isolation Voltage:	
	500 VDC min.
	3K VDC min.
	1.5K VDC min.
Isolation Resistance	
Switching Frequency	
Operating Ambient Temperature Range	-25°C to +71°C
Power de-rating Curve	see Figure1
Case Temperature (note 4)	Plastic/Copper case 95°C/100°C max.
Cooling	Natural Convection
Storage Temperature Range	-40°C to +100°C
Humidity	95% RH max. Non condensing
MTBF	MIL-STD-217F
Dimensions	DIP
	SMD
Case Material:	
	Standard Models
	Suffix "M" Models
Weight	12.5 g

NOTE

1. Measured from high line to low line.
2. Measured from full load to 10% load.
3. Measured from full load to 1/4 load.
4. Maximum case temperature under any operating condition should not be exceed 95°C (Plastic Case), 100°C (Copper Case).

EC3AE SERIES

3 WATT

Features

- ◆ 3W Isolated Output
- ◆ DIP-24/SMD Package
- ◆ Efficiency to 61%
- ◆ Regulated Outputs
- ◆ LC Input Filter
- ◆ Low Ripple and Noise

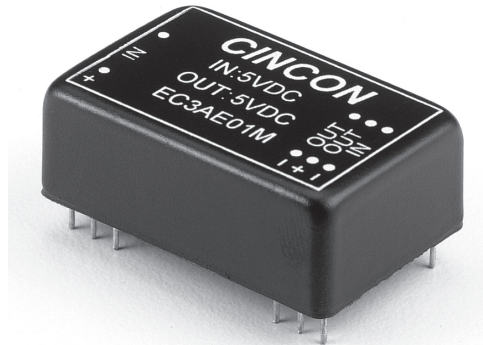

Mechanical Dimensions

NOTE: Pin Size is 0.02" Inch (0.5mm) DIA
 All Dimensions in Inches (mm)
 Tolerance Inches: X.XX±0.02, X.XXX±0.010
 Millimeters: X.X±0.5, X.XX±0.25

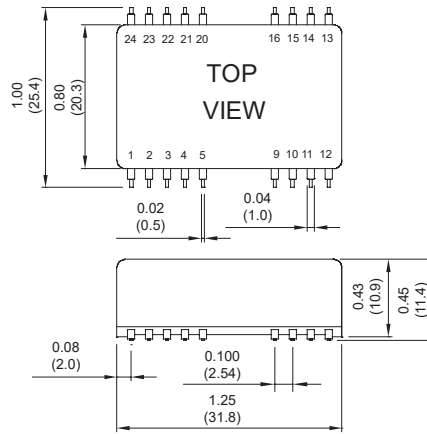
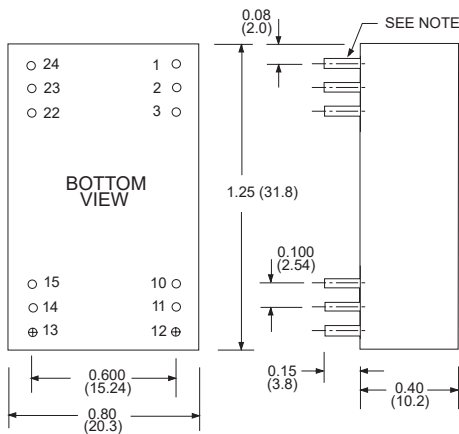

PIN CONNECTION				
500 VDC				
Pin	Single Output		Dual Output	
	DIP	SMD	DIP	SMD
1,24	+V Input		+V Input	
2,23	NC		-V Output	
3,22	NC		Common	
4,5	NP	NC	NP	NC
9	NP	NC	NP	NC
10,15	-V Output		Common	
11,14	+V Output		+V Output	
12,13	-V Input		-V Input	
16	NP	NC	NP	NC
20,21	NP	NC	NP	NC

* NC-NO CONNECTION WITH PIN
 * NP-No PIN

*0.41(10.4) for S/HS Models

MODEL NUMBER	INPUT VOLTAGE	OUTPUT VOLTAGE	OUTPUT CURRENT	INPUT CURRENT		% EFF.	CASE
				NO LOAD	FULL LOAD		
EC3AE01M	5 VDC	5 VDC	600 mA	120 mA	984 mA	61	DIP-24
EC3AE02M	5 VDC	12 VDC	250 mA	120 mA	984 mA	61	DIP-24
EC3AE03M	5 VDC	15 VDC	200 mA	120 mA	984 mA	61	DIP-24
EC3AE04M	5 VDC	±12 VDC	±125 mA	120 mA	984 mA	61	DIP-24
EC3AE05M	5 VDC	±15 VDC	±100 mA	120 mA	984 mA	61	DIP-24
EC3AE11M	12 VDC	5 VDC	600 mA	60 mA	410 mA	61	DIP-24
EC3AE12M	12 VDC	12 VDC	250 mA	60 mA	410 mA	61	DIP-24
EC3AE13M	12 VDC	15 VDC	200 mA	60 mA	410 mA	61	DIP-24
EC3AE14M	12 VDC	±12 VDC	±125 mA	60 mA	410 mA	61	DIP-24
EC3AE15M	12 VDC	±15 VDC	±100 mA	60 mA	410 mA	61	DIP-24
EC3AE21M	24 VDC	5 VDC	600 mA	40 mA	205 mA	61	DIP-24
EC3AE22M	24 VDC	12 VDC	250 mA	40 mA	205 mA	61	DIP-24
EC3AE23M	24 VDC	15 VDC	200 mA	40 mA	205 mA	61	DIP-24
EC3AE24M	24 VDC	±12 VDC	±125 mA	40 mA	205 mA	61	DIP-24
EC3AE25M	24 VDC	±15 VDC	±100 mA	40 mA	205 mA	61	DIP-24
EC3AE31M	28 VDC	5 VDC	600 mA	35 mA	176 mA	61	DIP-24
EC3AE32M	28 VDC	12 VDC	250 mA	35 mA	176 mA	61	DIP-24
EC3AE33M	28 VDC	15 VDC	200 mA	35 mA	176 mA	61	DIP-24
EC3AE34M	28 VDC	±12 VDC	±125 mA	35 mA	176 mA	61	DIP-24
EC3AE35M	28 VDC	±15 VDC	±100 mA	35 mA	176 mA	61	DIP-24
EC3AE41M	48 VDC	5 VDC	600 mA	20 mA	102 mA	61	DIP-24
EC3AE42M	48 VDC	12 VDC	250 mA	20 mA	102 mA	61	DIP-24
EC3AE43M	48 VDC	15 VDC	200 mA	20 mA	102 mA	61	DIP-24
EC3AE44M	48 VDC	±12 VDC	±125 mA	20 mA	102 mA	61	DIP-24
EC3AE45M	48 VDC	±15 VDC	±100 mA	20 mA	102 mA	61	DIP-24

Derating Curve

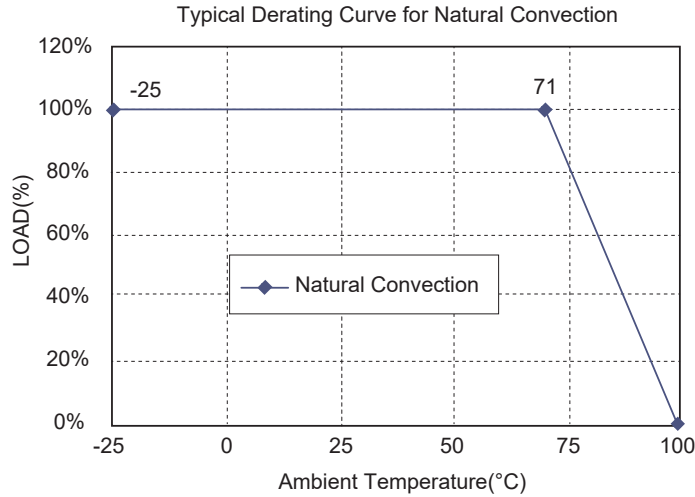

Specification

All Specifications Typical At Nominal Line, Full Load, and 25°C Unless Otherwise Noted

INPUT SPECIFICATIONS

Input Voltage Range	±10%
Input Filter	LC Type

ISOLATION VOLTAGE

500 VDC min.	Standard Models
--------------	-----------------

OUTPUT SPECIFICATIONS

Voltage Accuracy	±3.0% max.
Temperature coefficient	±0.02%/°C
Ripple & Noise, 20MHz BW	50mV pk-pk max.
Short Circuit Protection	Indefinite & Current Limit
Line Regulation (note 1)	±0.3% max.
Load Regulation (note 2)	±0.5% max.
	Single
	Dual
	±1.0% max.

CASE MATERIAL

Standard Models	Black Coated Copper with Non-Conductive Base
-----------------	---

NOTE

1. Measured from high line to low line.
2. Measured from full load to 10% load.
3. Suffix "S" to the model number with SMD packages.
4. Maximum case temperature under any operating condition should not be exceeded 100°C.

GENERAL SPECIFICATIONS

Efficiency	See Table
Isolation Capacitance	150pF typ.
Isolation Resistance	10 ⁹ ohm min.
Switching Frequency	80KHz typ.
Operating Ambient Temperature Range	-25°C to +71°C
De-rating, Above 71°C	Linearly to Zero power at 100°C
Case Temperature (note 4)	100°C max.
Cooling	Natural Convection
Storage Temperature Range	-40°C to +100°C
Dimensions	DIP
	SMD
	1.25 x 0.80 x 0.40 inches (31.8 x 20.3 x 10.2 mm)
	1.25 x 0.80 x 0.45 inches (31.8 x 20.3 x 11.4 mm)
Weight	17.2 g

EC3A-E SERIES

3 WATT, 2:1 INPUT RANGE

Features

- ◆ 3W Isolated Output
- ◆ 24-Pin DIP Package
- ◆ Efficiency to 87%
- ◆ 2 : 1 Input Range
- ◆ Regulated Outputs
- ◆ Pi Input Filter
- ◆ Continuous Short Circuit Protection
- ◆ Meet EMI EN55022 class A
- ◆ No Tantalum Capacitor inside
- ◆ Wide Operating Temperature Range
- ◆ UL60950-1 2nd Approval

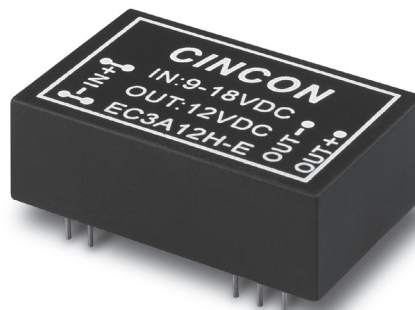

Mechanical Dimensions

NOTE: Pin Size is 0.02" Inch (0.5mm) DIA
 All Dimensions in Inches (mm)
 Tolerance Inches: X.XX=±0.02, X.XXX=±0.010
 Millimeters: X.X=±0.5, X.XX=±0.25

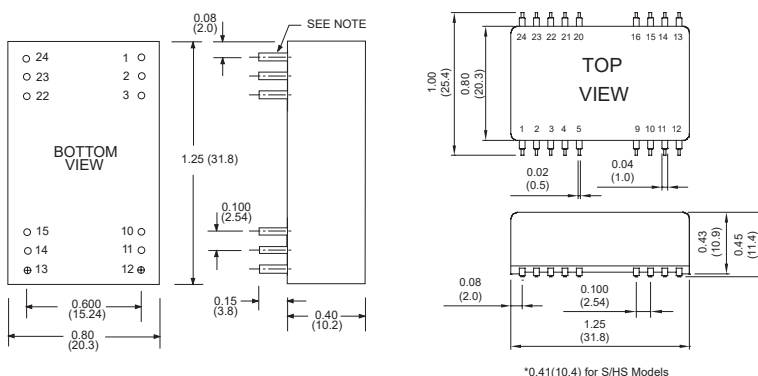

PIN CONNECTION									
Pin	500 VDC				1.5K & 3K VDC				
	Single Output		Dual Output		Pin	Single Output		Dual Output	
	DIP	SMD	DIP	SMD		DIP	SMD	DIP	SMD
1,24	+V Input		+V Input		1,24	NP	NC	NP	NC
2,23	NC		-V Output		2,3	-V Input		-V Input	
3,22	NC		Common		4,5	NP	NC	NP	NC
4	NP	NC	NP	NC	9	NC		Common	
5	NP	NC	NP	NC	10,15	NC		NC	
9	NP	NC	NP	NC	11	NC		-V Output	
10,15	-V Output		Common		12,13	NP	NC	NP	NC
11,14	+V Output		+V Output		14	+V Output		+V Output	
12,13	-V Input		-V Input		16	-V Output		Common	
16	NP	NC	NP	NC	20,21	NP	NC	NP	NC
20,21	NP	NC	NP	NC	22,23	+V Input		+V Input	

* NP-NO PIN
 * NC-NO CONNECTION WITH PIN

MODEL NUMBER	INPUT VOLTAGE	OUTPUT VOLTAGE	OUTPUT CURRENT	INPUT CURRENT		% EFF.	CAPACITOR LOAD MAX.
				NO LOAD	FULL LOAD		
EC3A01□-E	4.5-9 VDC	5 VDC	600 mA	15 mA	779 mA	77	2200µF
EC3A02□-E	4.5-9 VDC	12 VDC	250 mA	15 mA	750 mA	80	2200µF
EC3A03□-E	4.5-9 VDC	15 VDC	200 mA	15 mA	750 mA	80	2200µF
EC3A04□-E	4.5-9 VDC	±5 VDC	±300 mA	25 mA	779 mA	77	1000µF
EC3A05□-E	4.5-9 VDC	±12 VDC	±125 mA	25 mA	750 mA	80	1000µF
EC3A06□-E	4.5-9 VDC	±15 VDC	±100 mA	25 mA	750 mA	80	1000µF
EC3A07□-E	4.5-9 VDC	3.3 VDC	600 mA	15 mA	550 mA	72	2200µF
EC3A11□-E	9-18 VDC	5 VDC	600 mA	7.5 mA	309 mA	81	2200µF
EC3A12□-E	9-18 VDC	12 VDC	250 mA	10 mA	298 mA	84	2200µF
EC3A13□-E	9-18 VDC	15 VDC	200 mA	10 mA	294 mA	85	2200µF
EC3A14□-E	9-18 VDC	±5 VDC	±300 mA	15 mA	305 mA	82	1000µF
EC3A15□-E	9-18 VDC	±12 VDC	±125 mA	12 mA	298 mA	84	1000µF
EC3A16□-E	9-18 VDC	±15 VDC	±100 mA	15 mA	294 mA	85	1000µF
EC3A17□-E	9-18 VDC	3.3 VDC	600 mA	7.5 mA	212 mA	78	2200µF
EC3A21□-E	18-36 VDC	5 VDC	600 mA	7.5 mA	152 mA	82	2200µF
EC3A22□-E	18-36 VDC	12 VDC	250 mA	7.5 mA	145 mA	86	2200µF
EC3A23□-E	18-36 VDC	15 VDC	200 mA	7.5 mA	145 mA	86	2200µF
EC3A24□-E	18-36 VDC	±5 VDC	±300 mA	7.5 mA	152 mA	82	1000µF
EC3A25□-E	18-36 VDC	±12 VDC	±125 mA	10 mA	147 mA	85	1000µF
EC3A26□-E	18-36 VDC	±15 VDC	±100 mA	10 mA	145 mA	86	1000µF
EC3A27□-E	18-36 VDC	3.3 VDC	600 mA	5 mA	106 mA	78	2200µF
EC3A31□-E	36-72 VDC	5 VDC	600 mA	3 mA	74 mA	84	2200µF
EC3A32□-E	36-72 VDC	12 VDC	250 mA	3 mA	73 mA	86	2200µF
EC3A33□-E	36-72 VDC	15 VDC	200 mA	5 mA	73 mA	86	2200µF
EC3A34□-E	36-72 VDC	±5 VDC	±300 mA	5 mA	74 mA	85	1000µF
EC3A35□-E	36-72 VDC	±12 VDC	±125 mA	5 mA	72 mA	87	1000µF
EC3A36□-E	36-72 VDC	±15 VDC	±100 mA	5 mA	72 mA	87	1000µF
EC3A37□-E	36-72 VDC	3.3 VDC	600 mA	3 mA	52 mA	79	2200µF

NOTE:
 1. □ can be none, M, H, HM, S, MS, HS or HMS.
 2. Nominal input voltage is 5, 12, 24 or 48VDC.
 3. Typical value at nominal input voltage and full load.

Derating Curve

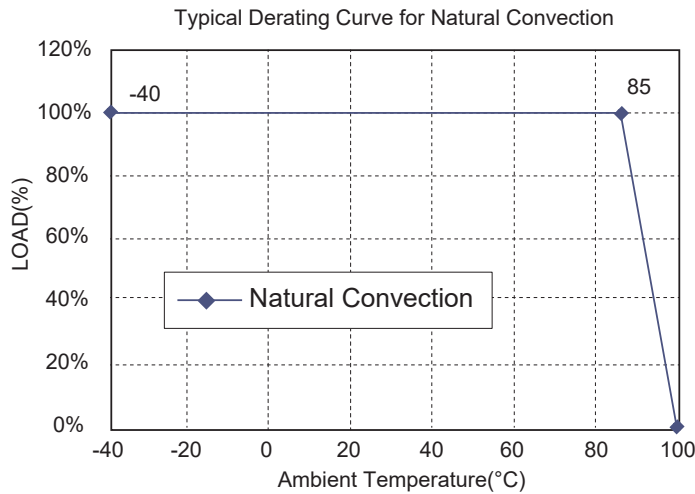

Specification

All Specifications Typical At Nominal Line, Full Load, and 25°C Unless Otherwise Noted

INPUT SPECIFICATIONS

Input Voltage Range	5V 4.5-9V
	12V 9-18V
	24V 18-36V
	48V 36-72V
Input Surge Voltage (100ms max.)	5V 10Vdc max.
	12V 25Vdc max.
	24V 50Vdc max.
	48V 100Vdc max.
Under Voltage Lockout	5V
	Power Up 4.4Vdc
	Power Down 4.2Vdc
	12V
	Power Up 8.8Vdc
	Power Down 8Vdc
	24V
	Power Up 17Vdc
	Power Down 16Vdc
	48V
	Power Up 34Vdc
	Power Down 31Vdc
Input Filter	Pi Type

OUTPUT SPECIFICATIONS

Voltage Accuracy	±1.5% max.
Voltage Balance (Dual)	±1.0% max.
Temperature Coefficient	±0.05%/°C
Ripple & Noise, 20MHz BW (note 5)	3.3V/5V ...100mV pk-pk, max.
	12V/15V1% pk-pk max.
Short Circuit Protection	Continuous
Line Regulation	Single/Dual (note 1)
	±0.5% max.
Load Regulation	Single (note 2)
	±0.5% max.
	Dual (note 3)
	±1.0% max.
Start up time	10 ms max.

GENERAL SPECIFICATIONS

Efficiency	See Table
Isolation Voltage:	
	500 VDC min.
	3K VDC min.
	1.5K VDC min.
Isolation Resistance	10 ⁹ ohm min.
Isolation Capacitance	250pF Typ.
Switching Frequency	100KHz min.
Operating Ambient Temperature Range	-40°C to +85°C
De-rating, Above 85°C	Linearly to Zero Power at 100°C
Case Temperature (note 4)	100°C max.
Cooling	Natural Convection
Storage Temperature Range	-40°C to +100°C
EMI	Conductive EMI Meet EN55022 Class A
Humidity	95% RH max. Non condensing
MTBFMIL-HDBK-217F	2500Khrs typ.
Dimensions	
	DIP
	1.25 x 0.80 x 0.40 inches (31.8 x 20.3 x 10.2 mm)
	MS/HMS Models
	1.25 x 0.80 x 0.45 inches (31.8 x 20.3 x 11.4 mm)
	S/HS Models
	1.25 x 0.80 x 0.41 inches (31.8 x 20.3 x 10.4 mm)
Case Material:	
Standard Models	Non-Conductive Black Plastic
Suffix "M" Models	Black Coated Copper with Non-Conductive Base
Suffix "S" Models	SMD package
Weight	12.5 g

NOTE

1. Measured from high line to low line.
2. Measured from full load to 10% load.
3. Measured from full load to 1/4 load.
4. Maximum case temperature under any operating condition should not exceed 100°C.
5. The output noise is measured with 0.1µF MLCC across for SMD package.

EC3AB SERIES

3 WATT, 2:1 INPUT RANGE

Features

- ◆ 3W Isolated Output
- ◆ DIP-24/SMD Package
- ◆ Efficiency to 80%
- ◆ Regulated Outputs
- ◆ Pi Input Filter
- ◆ Continuous Short Circuit Protection
- ◆ Meets EN55022 Class B, Conducted
- ◆ Remote ON/OFF (Option)

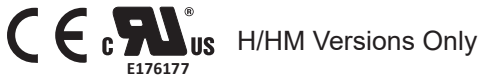
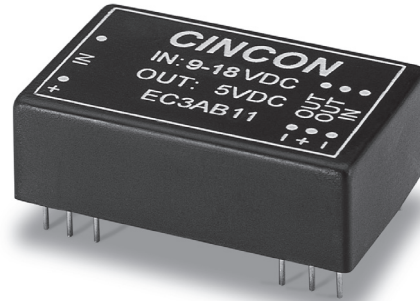

Mechanical Dimensions

NOTE: Pin Size is 0.02±0.002 Inch (0.5±0.05 mm) DIA
 All Dimensions in Inches (mm)
 Tolerance Inches: X.XX±0.02, X.XXX±0.010
 Millimeters: X.X±0.5, X.XX±0.25

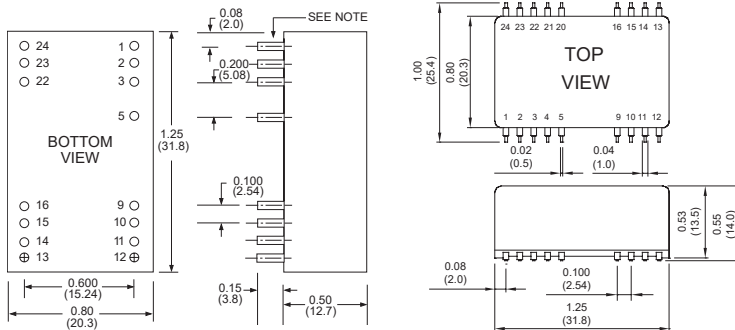

PIN CONNECTION									
500 VDC				1.5K & 3K VDC					
Pin	Single Output		Dual Output		Pin	Single Output		Dual Output	
	DIP	SMD	DIP	SMD		DIP	SMD	DIP	SMD
1,24	+V Input		+V Input		1,24	NP	NC	NP	NC
2,23	NC		-V Output		2,3	-V Input		-V Input	
3,22	NC		Common		4	NP	NC	NP	NC
4	NP	NC	NP	NC	5	NP/ Remote On/Off	NC/ Remote On/Off	NP/ Remote On/Off	NC/ Remote On/Off
5	NP	NC	NP	NC	9	NC		Common	
9	NP	NC	NP	NC	10,15	NC		NC	
10,15	-V Output		Common		11	NC		-V Output	
11,14	+V Output		+V Output		12,13	NP	NC	NP	NC
12,13	-V Input		-V Input		14	+V Output		+V Output	
16	NP	NC	NP	NC	16	-V Output		Common	
20	NP	NC	NP	NC	20,21	NP	NC	NP	NC
21	NP	NC	NP	NC	22,23	+V Input		+V Input	

* NC-NO CONNECTION WITH PIN
 * NP-NO PIN
 * Remote On/Off (Option)

MODEL NUMBER	INPUT VOLTAGE	OUTPUT VOLTAGE	OUTPUT CURRENT	INPUT CURRENT		% EFF.	CASE
				NO LOAD	FULL LOAD		
EC3AB11	9-18 VDC	5 VDC	600 mA	7.5 mA	329 mA	76	DIP-24
EC3AB12	9-18 VDC	12 VDC	250 mA	7.5 mA	316 mA	79	DIP-24
EC3AB13	9-18 VDC	15 VDC	200 mA	7.5 mA	321 mA	78	DIP-24
EC3AB14	9-18 VDC	±5 VDC	±300 mA	12 mA	329 mA	76	DIP-24
EC3AB15	9-18 VDC	±12 VDC	±125 mA	12 mA	325 mA	77	DIP-24
EC3AB16	9-18 VDC	±15 VDC	±100 mA	12 mA	329 mA	76	DIP-24
EC3AB17	9-18 VDC	3.3 VDC	600 mA	7.5 mA	229 mA	72	DIP-24
EC3AB21	18-36 VDC	5 VDC	600 mA	5 mA	162 mA	77	DIP-24
EC3AB22	18-36 VDC	12 VDC	250 mA	5 mA	156 mA	80	DIP-24
EC3AB23	18-36 VDC	15 VDC	200 mA	5 mA	156 mA	80	DIP-24
EC3AB24	18-36 VDC	±5 VDC	±300 mA	7.5 mA	164 mA	76	DIP-24
EC3AB25	18-36 VDC	±12 VDC	±125 mA	7.5 mA	156 mA	80	DIP-24
EC3AB26	18-36 VDC	±15 VDC	±100 mA	7.5 mA	162 mA	77	DIP-24
EC3AB27	18-36 VDC	3.3 VDC	600 mA	5 mA	111 mA	74	DIP-24
EC3AB31	36-72 VDC	5 VDC	600 mA	2 mA	81 mA	77	DIP-24
EC3AB32	36-72 VDC	12 VDC	250 mA	2 mA	81 mA	77	DIP-24
EC3AB33	36-72 VDC	15 VDC	200 mA	2 mA	81 mA	77	DIP-24
EC3AB34	36-72 VDC	±5 VDC	±300 mA	3 mA	80 mA	78	DIP-24
EC3AB35	36-72 VDC	±12 VDC	±125 mA	3 mA	82 mA	76	DIP-24
EC3AB36	36-72 VDC	±15 VDC	±100 mA	3 mA	82 mA	76	DIP-24
EC3AB37	36-72 VDC	3.3 VDC	600 mA	3 mA	58 mA	71	DIP-24

NOTE: 1. Nominal Input Voltage 12, 24 or 48 VDC

Derating Curve

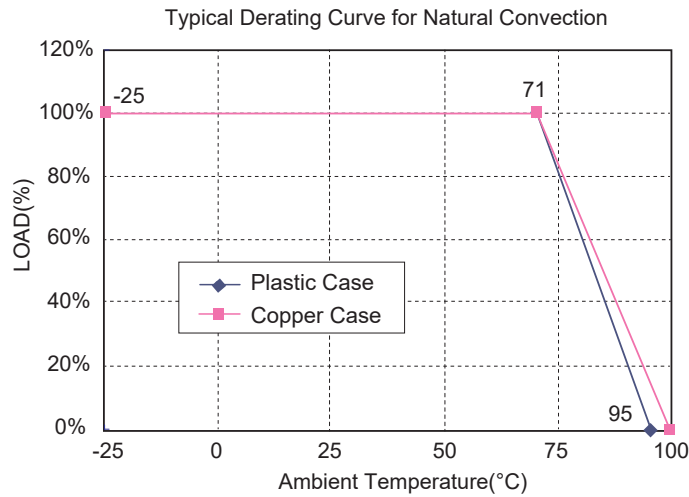

Specification

All Specifications Typical At Nominal Line, Full Load, and 25°C Unless Otherwise Noted

INPUT SPECIFICATIONS

Input Voltage Range	12V 9-18V
	24V 18-36V
	48V 36-72V
Positive Logic Remote On/Off (see note 6)	
Input Filter	Pi Type

OUTPUT SPECIFICATIONS

Voltage Accuracy	±2.0% max.
Voltage Balance (Dual)	±1.0% max.
Temperature Coefficient	±0.05%/°C
Ripple & Noise, 20MHz BW	3.3V/5V ...100mV pk-pk max. 12V/15V1% pk-pk max.
Short Circuit Protection	Continuous
Line Regulation Single/Dual (note 1)	±0.5% max.
Load Regulation (note 2) Single	±0.5% max.
	Dual (note 3) ±1.0% max.

GENERAL SPECIFICATIONS

Efficiency	See Table
Isolation Resistance	10 ⁹ ohm min.
Switching Frequency	100KHz min.
Operating Ambient Temperature Range	-25°C to +71°C
De-rating, Above 71°C (Plastic Case)	Linearly to Zero power at 95°C
De-rating, Above 71°C (Copper Case)	Linearly to Zero power at 100°C
Case Temperature (Plastic case note 8)	95°C max.
	(Copper case note 8) 100°C max.
Cooling	Natural Convection
Storage Temperature Range	-40°C to +100°C
EMI/RFI	Conductive EMI Meet EN55022 Class B
Dimensions	DIP 1.25 x 0.80 x 0.50 inches (31.8 x 20.3 x 12.7 mm)
	SMD 1.25 x 0.80 x 0.55 inches (31.8 x 20.3 x 14.0 mm)

ISOLATION VOLTAGE

500 VDC min.	Standard Models
3K VDC min. (note 4)	Suffix "H" Models
1.5K VDC min.	Suffix "HM" Models

CASE MATERIAL

Standard Models	Non-Conductive Black Plastic
Suffix "M" Models	Black Coated Copper with Non-Conductive Base

NOTE

1. Measured from high line to low line.
2. Measured from full load to 10% load.
3. Measured from full load to 1/4 load.
4. Non-conductive black plastic only.
5. Suffix "T" to the model number with remote on/off for "H"/"HM" versions only.
6. Logic Compatibility CMOS or open collector TTL, ref. to -Vin
Module On >5.5Vdc or open circuit
Module Off < 1.8Vdc.
Shutdown Idle 10mA
Control common referenced to input minus
7. Suffix "S" to the model number with SMD packages.
8. Maximum case temperature under any operating condition should not be exceeded 95°C (Plastic Case), 100°C (Copper Case).

EC3AW SERIES

3 WATT, 4:1 INPUT RANGE

Features

- ◆ 3W Isolated Output
- ◆ DIP-24/SMD Package
- ◆ Efficiency to 77%
- ◆ 4 : 1 Input Range
- ◆ Regulated Outputs
- ◆ Pi Input Filter
- ◆ Continuous Short Circuit Protection

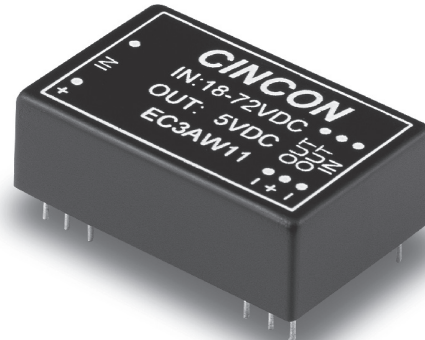

Mechanical Dimensions

NOTE: Pin Size is 0.02±0.002 Inch (0.5±0.05 mm) DIA
 All Dimensions in Inches (mm)
 Tolerance Inches: X.XX±0.02, X.XXX±0.010
 Millimeters: X.X±0.5, X.XX±0.25

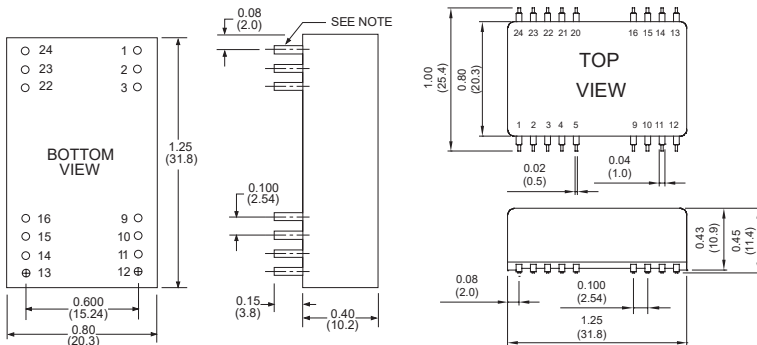

PIN CONNECTION									
Pin	500 VDC				1.5K & 3K VDC				
	Single Output		Dual Output		Pin	Single Output		Dual Output	
	DIP	SMD	DIP	SMD		DIP	SMD	DIP	SMD
1,24	+V Input		+V Input		1,24	NP	NC	NP	NC
2,23	NC		-V Output		2,3	-V Input		-V Input	
3,22	NC		Common		4,5	NP	NC	NP	NC
4	NP	NC	NP	NC	9	NC		Common	
5	NP	NC	NP	NC	10,15	NC		NC	
9	NP	NC	NP	NC	11	NC		-V Output	
10,15	-V Output		Common		12,13	NP	NC	NP	NC
11,14	+V Output		+V Output		14	+V Output		+V Output	
12,13	-V Input		-V Input		16	-V Output		Common	
16	NP	NC	NP	NC	20,21	NP	NC	NP	NC
20,21	NP	NC	NP	NC	22,23	+V Input		+V Input	

* NP-NO PIN
 * NC-NO CONNECTION WITH PIN

MODEL NUMBER	INPUT VOLTAGE	OUTPUT VOLTAGE	OUTPUT CURRENT	INPUT CURRENT		% EFF.	CASE
				NO LOAD	FULL LOAD		
EC3AW01	9-36 VDC	5 VDC	600 mA	15 mA	174 mA	72	DIP-24
EC3AW02	9-36 VDC	12 VDC	250 mA	15 mA	165 mA	76	DIP-24
EC3AW03	9-36 VDC	15 VDC	200 mA	15 mA	165 mA	76	DIP-24
EC3AW04	9-36 VDC	±5 VDC	±300 mA	25 mA	179 mA	70	DIP-24
EC3AW05	9-36 VDC	±12 VDC	±125 mA	25 mA	174 mA	72	DIP-24
EC3AW06	9-36 VDC	±15 VDC	±100 mA	25 mA	174 mA	72	DIP-24
EC3AW07	9-36 VDC	3.3 VDC	600 mA	15 mA	117 mA	70	DIP-24
EC3AW11	18-72 VDC	5 VDC	600 mA	7.5 mA	87 mA	72	DIP-24
EC3AW12	18-72 VDC	12 VDC	250 mA	7.5 mA	81 mA	77	DIP-24
EC3AW13	18-72 VDC	15 VDC	200 mA	7.5 mA	81 mA	77	DIP-24
EC3AW14	18-72 VDC	±5 VDC	±300 mA	12 mA	88 mA	71	DIP-24
EC3AW15	18-72 VDC	±12 VDC	±125 mA	12 mA	87 mA	72	DIP-24
EC3AW16	18-72 VDC	±15 VDC	±100 mA	12 mA	87 mA	72	DIP-24
EC3AW17	18-72 VDC	3.3 VDC	600 mA	7.5 mA	58 mA	70	DIP-24

NOTE: 1. Nominal Input Voltage 24 or 48 VDC

Derating Curve

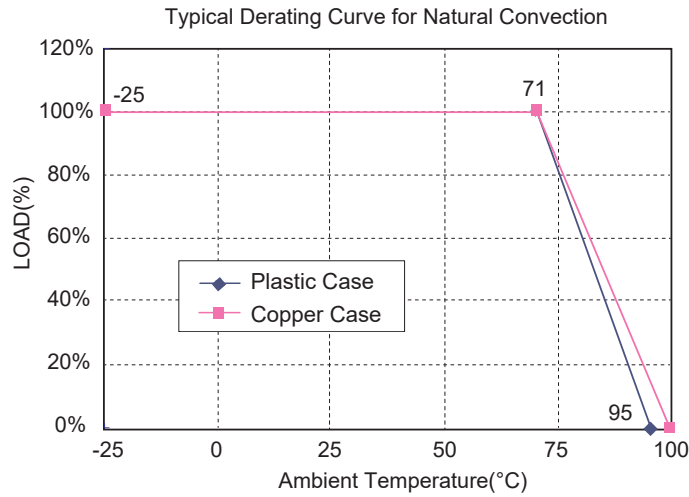

Specification

All Specifications Typical At Nominal Line, Full Load, and 25°C Unless Otherwise Noted

INPUT SPECIFICATIONS

Input Voltage Range	24V 9-36V
	48V 18-72V
Input Filter	Pi Type

ISOLATION VOLTAGE

500 VDC min.	Standard Models
3K VDC min. (note 4)	Suffix "H" Models
1.5K VDC min.	Suffix "HM" Models

OUTPUT SPECIFICATIONS

Voltage Accuracy	±2.0% max.
Voltage Balance (Dual)	±1.0% max.
Temperature Coefficient	±0.05%/°C
Ripple & Noise, 20MHz BW Single & ±5V Dual	100mV pk-pk max. 1% pk-pk max.
Short Circuit Protection	Continuous
Line Regulation Single/Dual (note 1)	±0.5% max.
Load Regulation Single (note 2)	±0.5% max.
Dual (note 3)	±1.0% max.

CASE MATERIAL

Standard Models	Non-Conductive Black Plastic
Suffix "M" Models	Black Coated Copper with Non-conductive Base

NOTE

1. Measured from high line to low line.
2. Measured from full load to 10% load.
3. Measured from full load to 1/4 load.
4. Non-conductive black plastic only.
5. Suffix "S" to the model number with SMD packages.
6. Maximum case temperature under any operating condition should not be exceeded 95°C (Plastic Case), 100°C (Copper Case).

GENERAL SPECIFICATIONS

Efficiency	See Table
Isolation Resistance	10 ⁹ ohm min.
Switching Frequency	100KHz min.
Operating Ambient Temperature Range	-25°C to +71°C
De-rating, Above 71°C (Plastic Case)	Linearly to Zero power at 95°C
De-rating, Above 71°C (Copper Case)	Linearly to Zero power at 100°C
Case Temperature (Plastic case note 6)	95°C max.
(Copper case note 6)	100°C max.
Cooling	Natural Convection
Storage Temperature Range	-40°C to +100°C
Dimension	DIP
	SMD
	1.25 x 0.80 x 0.40 inches (31.8 x 20.3 x 10.2 mm)
	1.25 x 0.80 x 0.45 inches (31.8 x 20.3 x 11.4 mm)
Weight	12.5 g

EC4A SERIES

5-6 WATT, 2:1 INPUT RANGE

Features

- ◆ 5-6W Isolated Output
- ◆ 24-Pin DIP Package
- ◆ Efficiency to 84%
- ◆ 2 : 1 Input Range
- ◆ Regulated Outputs
- ◆ Pi Input Filter
- ◆ Continuous Short Circuit Protection
- ◆ UL60950-1 Approval for H/HM Versions only

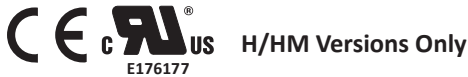
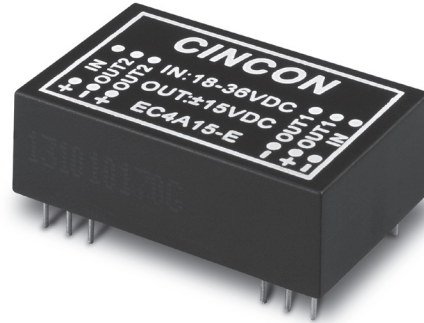

Mechanical Dimensions

NOTE: Pin Size is 0.02±0.002 Inch (0.5±0.05 mm) DIA
 All Dimensions in Inches (mm)
 Tolerance Inches: X.XX±0.02, X.XXX±0.010
 Millimeters: X.X±0.5, X.XX±0.25

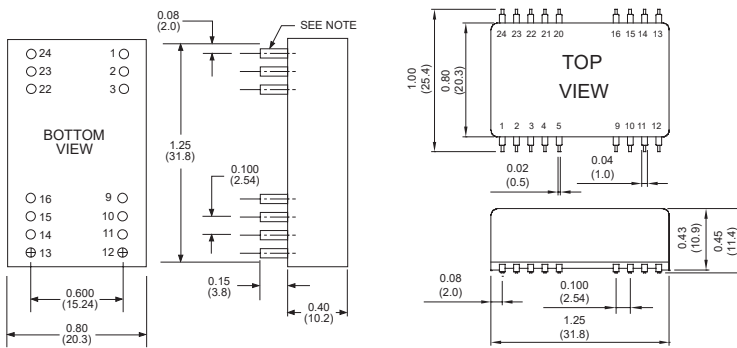

* 0.41(10.4)mm for "E" Version S/HS Models

PIN CONNECTION									
Pin	500 VDC				1.5K & 3K VDC				
	Single Output		Dual Output		Pin	Single Output		Dual Output	
	DIP	SMD	DIP	SMD		DIP	SMD	DIP	SMD
1,24	+V Input		+V Input		1,24	NP	NC	NP	NC
2,23	NC		-V Output		2,3	-V Input		-V Input	
3,22	NC		Common		4,5	NP	NC	NP	NC
4	NP	NC	NP	NC	9	NC		Common	
5	NP	NC	NP	NC	10,15	NC		NC	
9	NP	NC	NP	NC	11	NC		-V Output	
10,15	-V Output		Common		12,13	NP	NC	NP	NC
11,14	+V Output		+V Output		14	+V Output		+V Output	
12,13	-V Input		-V Input		16	-V Output		Common	
16	NP	NC	NP	NC	20,21	NP	NC	NP	NC
20,21	NP	NC	NP	NC	22,23	+V Input		+V Input	

* NP-NO PIN

* NC-NO CONNECTION WITH PIN

MODEL NUMBER	INPUT VOLTAGE	OUTPUT VOLTAGE	OUTPUT CURRENT	INPUT CURRENT		% EFF.	CAPACITOR LOAD MAX.
				NO LOAD	FULL LOAD		
EC4A01	9-18 VDC	5 VDC	1000 mA	7.5 mA	541 mA	77	4700µF
EC4A02	9-18 VDC	12 VDC	470 mA	7.5 mA	573 mA	82	4700µF
EC4A03	9-18 VDC	15 VDC	400 mA	7.5 mA	625 mA	80	4700µF
EC4A04	9-18 VDC	±12 VDC	±230 mA	12 mA	554 mA	83	2200µF
EC4A05	9-18 VDC	±15 VDC	±190 mA	12 mA	556 mA	81	2200µF
EC4A06	9-18 VDC	±5 VDC	±500 mA	12 mA	541 mA	77	2200µF
EC4A07	9-18 VDC	3.3 VDC	1000 mA	7.5 mA	382 mA	72	4700µF
EC4A11	18-36 VDC	5 VDC	1000 mA	5 mA	260 mA	80	4700µF
EC4A12	18-36 VDC	12 VDC	470 mA	5 mA	280 mA	84	4700µF
EC4A13	18-36 VDC	15 VDC	400 mA	5 mA	298 mA	84	4700µF
EC4A14	18-36 VDC	±12 VDC	±230 mA	7.5 mA	280 mA	82	2200µF
EC4A15	18-36 VDC	±15 VDC	±190 mA	7.5 mA	293 mA	81	2200µF
EC4A16	18-36 VDC	±5 VDC	±500 mA	7.5 mA	260 mA	80	2200µF
EC4A17	18-36 VDC	3.3 VDC	1000 mA	5 mA	186 mA	74	4700µF
EC4A21	36-72 VDC	5 VDC	1000 mA	2 mA	132 mA	79	4700µF
EC4A22	36-72 VDC	12 VDC	470 mA	2 mA	142 mA	83	4700µF
EC4A23	36-72 VDC	15 VDC	400 mA	2 mA	154 mA	81	4700µF
EC4A24	36-72 VDC	±12 VDC	±230 mA	3 mA	142 mA	81	2200µF
EC4A25	36-72 VDC	±15 VDC	±190 mA	3 mA	147 mA	81	2200µF
EC4A26	36-72 VDC	±5 VDC	±500 mA	3 mA	130 mA	80	2200µF
EC4A27	36-72 VDC	3.3 VDC	1000 mA	2 mA	93 mA	74	4700µF

NOTE:
 1. Nominal Input Voltage is 12, 24 or 48 VDC.
 2. Typical value at nominal input voltage and full load.

Derating Curve

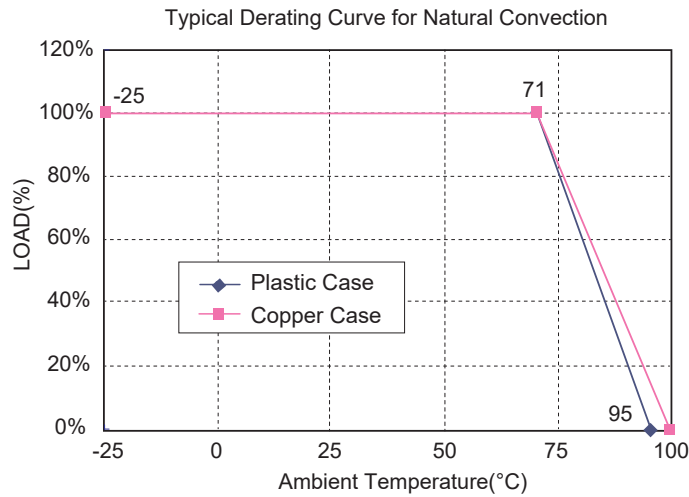

Specification

All Specifications Typical At Nominal Line, Full Load, and 25°C Unless Otherwise Noted

INPUT SPECIFICATIONS

Input Voltage Range	12V 9-18V
	24V 18-36V
	48V 36-72V
Input Surge Voltage (100ms max.)	12V 25Vdc max.
	24V 50Vdc max.
	48V 100Vdc max.
Input Filter	Pi Type

OUTPUT SPECIFICATIONS

Voltage Accuracy	±2.0% max.
Voltage Balance (Dual)	±1.0% max.
Temperature Coefficient	±0.05%/°C
Ripple & Noise, 20MHz BW	3.3V/5V....100mV pk-pk, max
	12V/15V.....1% pk-pk max.
Short Circuit Protection	Continuous
Line Regulation	Single/Dual (note 1)
Load Regulation	Single (note 2)
	Dual (note 3)

NOTE

1. Measured from high line to low line.
2. Measured from full load to 10% load.
3. Measured from full load to 1/4 load.
4. Maximum case temperature under any operating condition should not be exceed 95°C (Plastic Case), 100°C (Copper Case).

GENERAL SPECIFICATIONS

Efficiency	See Table
Isolation Voltage:	
500 VDC min.	Standard Models
3K VDC min.	Suffix "H" Models
(Non-Conductive Black Plastic Only)	
1.5K VDC min.	Suffix "HM" Models
Isolation Resistance	10 ⁹ ohm min.
Switching Frequency	100KHz min.
Operating Ambient Temperature Range	-25°C to +71°C
Power de-rating Curve	see Figure1
Case Temperature (note 4)	Plastic/Copper case.
	95°C/100°C max.
Cooling	Natural Convection
Storage Temperature Range	-40°C to +100°C
Humidity	95% RH max. Non condensing
MTBF.....MIL-STD-217F	2000Khrs typ.
Dimensions	DIP
	SMD
Case Material:	
Standard Models	Non-Conductive Black Plastic
Suffix "M" Models	Black Coated Copper with
	Non-conductive Base
Suffix "S" Models	SMD package
Weight	12.5 g

EC4A-E SERIES

5-6 WATT, 2:1 INPUT RANGE

Features

- ◆ 5-6W Isolated Output
- ◆ 24-Pin DIP Package
- ◆ Efficiency to 87%
- ◆ 2 : 1 Input Range
- ◆ Regulated Outputs
- ◆ Pi Input Filter
- ◆ Continuous Short Circuit Protection
- ◆ Meet EMI EN55022 class A
- ◆ No Tantalum Capacitor inside
- ◆ Wide Operating Temperature Range
- ◆ UL60950-1 Approval

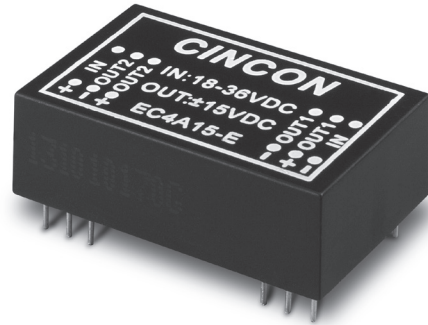

Mechanical Dimensions

NOTE: Pin Size is 0.02±0.002 Inch (0.5±0.05 mm) DIA
 All Dimensions in Inches (mm)
 Tolerance Inches: X.XX±0.02, X.XXX±0.010
 Millimeters: X.X±0.5, X.XX±0.25

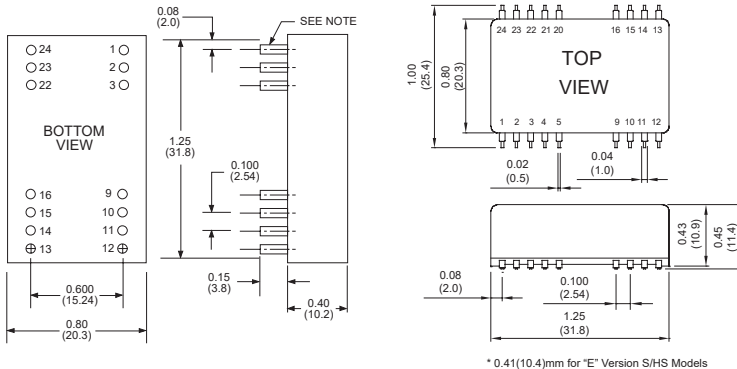

* 0.41(10.4)mm for "E" Version S/HS Models

PIN CONNECTION									
Pin	500 VDC				1.5K & 3K VDC				
	Single Output		Dual Output		Single Output		Dual Output		
	DIP	SMD	DIP	SMD	DIP	SMD	DIP	SMD	
1,24	+V Input	+V Input	1,24	NP	NC	NP	NC	NC	
2,23	NC	-V Output	2,3	-V Input	-V Input				
3,22	NC	Common	4,5	NP	NC	NP	NC		
4	NP	NC	NP	NC	9	NC	Common		
5	NP	NC	NP	NC	10,15	NC	NC		
9	NP	NC	NP	NC	11	NC	-V Output		
10,15	-V Output	Common	12,13	NP	NC	NP	NC		
11,14	+V Output	+V Output	14	+V Output	+V Output				
12,13	-V Input	-V Input	16	-V Output	Common				
16	NP	NC	NP	NC	20,21	NP	NC	NP	NC
20,21	NP	NC	NP	NC	22,23	+V Input	+V Input		

* NP-NO PIN

* NC-NO CONNECTION WITH PIN

MODEL NUMBER	INPUT VOLTAGE	OUTPUT VOLTAGE	OUTPUT CURRENT	INPUT CURRENT		% EFF.	CAPACITOR LOAD MAX.
				NO LOAD	FULL LOAD		
EC4A01□-E	9-18 VDC	5 VDC	1000 mA	7.5 mA	514 mA	81	4700µF
EC4A02□-E	9-18 VDC	12 VDC	500 mA	10 mA	595 mA	84	4700µF
EC4A03□-E	9-18 VDC	15 VDC	400 mA	15 mA	588 mA	85	4700µF
EC4A04□-E	9-18 VDC	±12 VDC	±250 mA	12 mA	588 mA	85	2200µF
EC4A05□-E	9-18 VDC	±15 VDC	±200 mA	18 mA	588 mA	85	2200µF
EC4A06□-E	9-18 VDC	±5 VDC	±500 mA	12 mA	514 mA	81	2200µF
EC4A07□-E	9-18 VDC	3.3 VDC	1200 mA	7.5 mA	429 mA	77	4700µF
EC4A11□-E	18-36 VDC	5 VDC	1000 mA	5 mA	251 mA	83	4700µF
EC4A12□-E	18-36 VDC	12 VDC	500 mA	8 mA	291 mA	86	4700µF
EC4A13□-E	18-36 VDC	15 VDC	400 mA	8 mA	287 mA	87	4700µF
EC4A14□-E	18-36 VDC	±12 VDC	±250 mA	8 mA	291 mA	86	2200µF
EC4A15□-E	18-36 VDC	±15 VDC	±200 mA	10 mA	287 mA	87	2200µF
EC4A16□-E	18-36 VDC	±5 VDC	±500 mA	8 mA	254 mA	82	2200µF
EC4A17□-E	18-36 VDC	3.3 VDC	1200 mA	5 mA	209 mA	79	4700µF
EC4A21□-E	36-72 VDC	5 VDC	1000 mA	3 mA	126 mA	83	4700µF
EC4A22□-E	36-72 VDC	12 VDC	500 mA	6 mA	144 mA	87	4700µF
EC4A23□-E	36-72 VDC	15 VDC	400 mA	6 mA	144 mA	87	4700µF
EC4A24□-E	36-72 VDC	±12 VDC	±250 mA	6 mA	144 mA	87	2200µF
EC4A25□-E	36-72 VDC	±15 VDC	±200 mA	6 mA	144 mA	87	2200µF
EC4A26□-E	36-72 VDC	±5 VDC	±500 mA	5 mA	126 mA	83	2200µF
EC4A27□-E	36-72 VDC	3.3 VDC	1200 mA	2 mA	104 mA	79	4700µF

NOTE:

- can be none, M, H, HM, S, MS, HS or HMS.
- Nominal Input Voltage is 12, 24 or 48 VDC.
- Typical value at nominal input voltage and full load.

Derating Curve

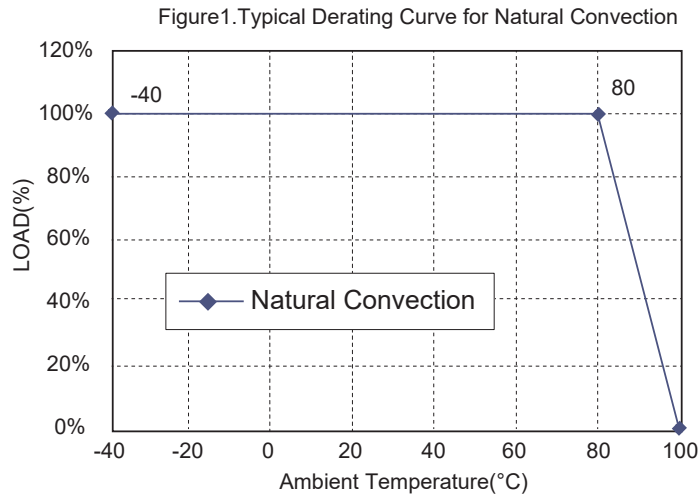

Specification

All Specifications Typical At Nominal Line, Full Load, and 25°C Unless Otherwise Noted

INPUT SPECIFICATIONS

Input Voltage Range	12V 9-18V
	24V 18-36V
	48V 36-72V
Input Surge Voltage (100ms max.)	12V 25Vdc max.
	24V 50Vdc max.
	48V 100Vdc max.
Under Voltage Lockout	12V Power Up 8.8Vdc
	Power Down 8Vdc
	24V Power Up 17Vdc
	Power Down 16Vdc
	48V Power Up 34Vdc
	Power Down 31Vdc

OUTPUT SPECIFICATIONS

Voltage Accuracy	±1.5% max.
Voltage Balance (Dual)	±1.0% max.
Temperature Coefficient	±0.05%/°C
Ripple & Noise, 20MHz BW (note 5)	3.3V/5V 100mV pk-pk, max.
	12V/15V 1% pk-pk, max.
Short Circuit Protection	Continuous
Line Regulation	Single/Dual (note 1) ±0.5% max.
Load Regulation	Single (note 2) ±0.5% max.
	Dual (note 3) ±1.0% max.
Start up time	5 ms max.

NOTE

1. Measured from high line to low line.
2. Measured from full load to 10% load.
3. Measured from full load to 1/4 load.
4. Maximum case temperature under any operating condition should not exceed 100°C.
5. The output noise is measured with 0.1µF MLCC across for SMD package.

GENERAL SPECIFICATIONS

Efficiency	See Table
Isolation Voltage:	Standard Models
	500 VDC min.
	3K VDC min.
	(Non-Conductive Black Plastic Only)
	1.5K VDC min.
Isolation Resistance	Suffix "H" Models
Isolation Capacitance	Suffix "HM" Models
Switching Frequency	10 ⁹ ohm min.
Operating Ambient Temperature Range	250pF typ.
De-rating, Above 80°C	100KHz min.
Case Temperature	-40°C to +85°C
Cooling	Linearly to Zero Power at 100°C
Storage Temperature Range	100°C max.
EMI	Natural Convection
	-40°C to +100°C
	Conductive EMI Meet EN55022
	Class A
Humidity	95% RH max. Non condensing
MTBF.....MIL-STD-217F	1800Khrs typ.
Dimensions	DIP
	1.25 × 0.80 × 0.40 inches
	(31.8 × 20.3 × 10.2 mm)
	MS/HMS Models
	1.25 × 0.80 × 0.45 inches
	(31.8 × 20.3 × 11.4 mm)
	S/HS Models
	1.25 × 0.80 × 0.41 inches
	(31.8 × 20.3 × 10.4 mm)
Case Material:	
	Standard Models
	Suffix "M" Models
	Suffix "S" Models
Weight	Non-Conductive Black Plastic
	Black Coated Copper with
	Non-conductive Base
	SMD package
	12.5 g

EC4AB SERIES

5-6 WATT, 2:1 INPUT

Features

- ◆ 5-6W Isolated Output
- ◆ DIP-24/SMD Package
- ◆ Efficiency to 84%
- ◆ Regulated Outputs
- ◆ Pi Input Filter
- ◆ Continuous Short Circuit Protection
- ◆ Meets EN55022 Class B, Conducted
- ◆ Remote On/Off (Option)

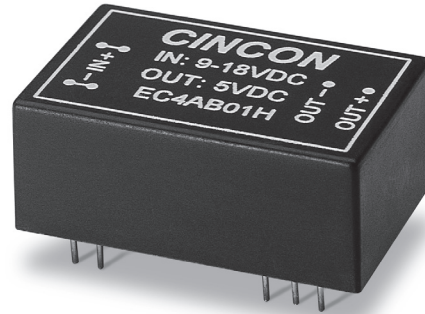
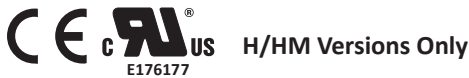

Mechanical Dimensions

NOTE: Pin Size is 0.02±0.002 Inch (0.5±0.05 mm) DIA
All Dimensions in Inches (mm)

Tolerance Inches: X.XX±0.02, X.XXX±0.010
Millimeters: X.X±0.5, X.XX±0.25

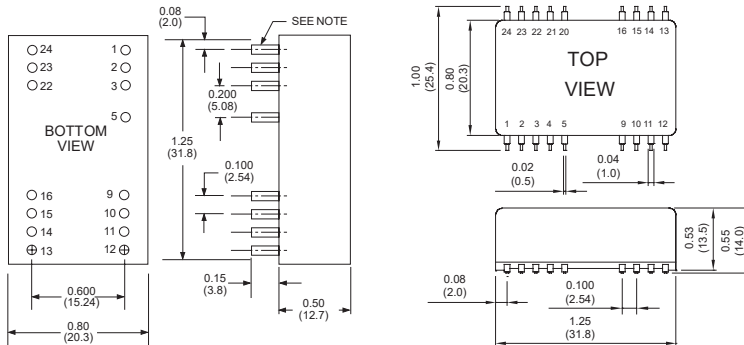

PIN CONNECTION									
500 VDC				1.5K & 3K VDC					
Pin	Single Output		Dual Output		Pin	Single Output		Dual Output	
	DIP	SMD	DIP	SMD		DIP	SMD	DIP	SMD
1,24	+V Input		+V Input		1,24	NP	NC	NP	NC
2,23	NC		-V Output		2,3	-V Input		-V Input	
3,22	NC		Common		4	NP	NC	NP	NC
4	NP	NC	NP	NC	5	NP/ Remote On/Off	NC/ Remote On/Off	NP/ Remote On/Off	NC/ Remote On/Off
5	NP	NC	NP	NC	9	NC		Common	
9	NP	NC	NP	NC	10,15	NC		NC	
10,15	-V Output		Common		11	NC		-V Output	
11,14	+V Output		+V Output		12,13	NP	NC	NP	NC
12,13	-V Input		-V Input		14	+V Output		+V Output	
16	NP	NC	NP	NC	16	-V Output		Common	
20	NP	NC	NP	NC	20,21	NP	NC	NP	NC
21	NP	NC	NP	NC	22,23	+V Input		+V Input	

* NP-NO PIN
* NC-NO CONNECTION WITH PIN
* Remote On/Off(Option)

MODEL NUMBER	INPUT VOLTAGE	OUTPUT VOLTAGE	OUTPUT CURRENT	INPUT CURRENT		% EFF.	CASE
				NO LOAD	FULL LOAD		
EC4AB01	9-18 VDC	5 VDC	1000 mA	7.5 mA	548 mA	76	DIP-24
EC4AB02	9-18 VDC	12 VDC	470 mA	7.5 mA	588 mA	80	DIP-24
EC4AB03	9-18 VDC	15 VDC	400 mA	7.5 mA	617 mA	81	DIP-24
EC4AB04	9-18 VDC	±12 VDC	±230 mA	12 mA	568 mA	81	DIP-24
EC4AB05	9-18 VDC	±15 VDC	±190 mA	12 mA	586 mA	81	DIP-24
EC4AB06	9-18 VDC	±5 VDC	±500 mA	12 mA	548 mA	76	DIP-24
EC4AB07	9-18 VDC	3.3 VDC	1000 mA	7.5 mA	382 mA	72	DIP-24
EC4AB11	18-36 VDC	5 VDC	1000 mA	5 mA	264 mA	79	DIP-24
EC4AB12	18-36 VDC	12 VDC	470 mA	5 mA	283 mA	83	DIP-24
EC4AB13	18-36 VDC	15 VDC	400 mA	5 mA	298 mA	84	DIP-24
EC4AB14	18-36 VDC	±12 VDC	±230 mA	7.5 mA	284 mA	81	DIP-24
EC4AB15	18-36 VDC	±15 VDC	±190 mA	7.5 mA	290 mA	82	DIP-24
EC4AB16	18-36 VDC	±5 VDC	±500 mA	7.5 mA	264 mA	79	DIP-24
EC4AB17	18-36 VDC	3.3 VDC	1000 mA	5 mA	188 mA	73	DIP-24
EC4AB21	36-72 VDC	5 VDC	1000 mA	2 mA	132 mA	79	DIP-24
EC4AB22	36-72 VDC	12 VDC	470 mA	2 mA	143 mA	82	DIP-24
EC4AB23	36-72 VDC	15 VDC	400 mA	2 mA	154 mA	81	DIP-24
EC4AB24	36-72 VDC	±12 VDC	±230 mA	3 mA	142 mA	81	DIP-24
EC4AB25	36-72 VDC	±15 VDC	±190 mA	3 mA	148 mA	80	DIP-24
EC4AB26	36-72 VDC	±5 VDC	±500 mA	3 mA	132 mA	79	DIP-24
EC4AB27	36-72 VDC	3.3 VDC	1000 mA	3 mA	94 mA	73	DIP-24

NOTE: 1.Nominal Input voltage 12, 24 or 48 VDC

Derating Curve

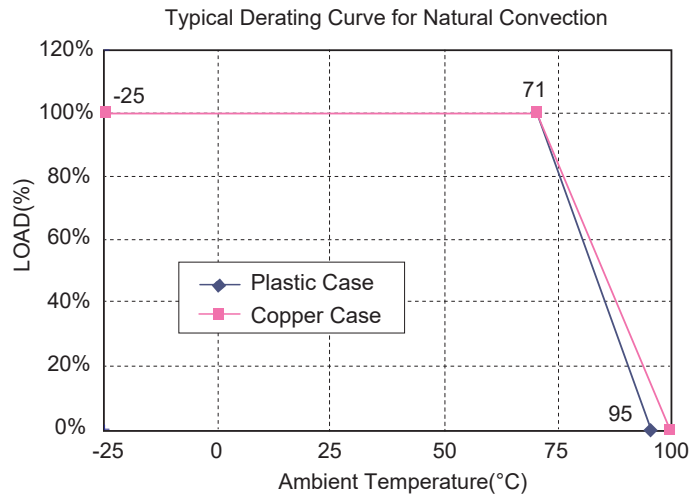

Specification

All Specifications Typical At Nominal Line, Full Load, and 25°C Unless Otherwise Noted

INPUT SPECIFICATIONS

Input Voltage Range	12V 9-18V
	24V 18-36V
	48V 36-72V

Positive Logic Remote On/Off (see note 6)
Input Filter

Pi Type

OUTPUT SPECIFICATIONS

Voltage Accuracy	±2.0% max.
Voltage Balance (Dual)	±1.0% max.
Temperature Coefficient	±0.05%/°C
Ripple & Noise, 20MHz BW	3.3V/5V.....100mV pk-pk max. 12V/15V.....1% pk-pk max.
Short Circuit Protection	Continuous
Line Regulation Single/Dual (note 1)	±0.5% max.
Load Regulation (note 2) Single	±0.5% max.
Dual (note 3)	±1.0% max.

GENERAL SPECIFICATIONS

Efficiency	See Table
Isolation Resistance	10 ⁹ ohm min.
Switching Frequency	100KHz min.
Operating Ambient Temperature Range	-25°C to +71°C
De-rating, Above 71°C (Plastic Case)	Linearly to Zero power at 95°C
De-rating, Above 71°C (Copper Case)	Linearly to Zero power at 100°C
Case Temperature (Plastic case note 8)	95°C max.
(Copper case note 8)	100°C max.
Cooling	Natural Convection
Storage Temperature Range	-40°C to +100°C
EMI/RFI	Conductive EMI Meet EN55022 Class B
Dimensions	DIP 1.25 × 0.80 × 0.50 inches (31.8 × 20.3 × 1 2.7 mm)
	SMD 1.25 × 0.80 × 0.55 inches (31.8 × 20.3 × 14.0 mm)
Weight	15 g

ISOLATION VOLTAGE

500 VDC min.
3K VDC min. (note 4)
1.5K VDC min.

Standard Models
Suffix "H" Models
Suffix "HM" Models

CASE MATERIAL

Standard Models
Suffix "M" Models

Non-Conductive Black Plastic
Black Coated Copper with
Non-conductive Base

NOTE

1. Measured from high line to low line.
2. Measured from full load to 10% load.
3. Measured from full load to 1/4 load.
4. Non-conductive black plastic only.
5. Suffix "T" to the model number with remote on/off for "H"/"HM" versions only.
6. Logic Compatibility CMOS or open collector TTL, ref. to -Vin
Module On >5.5VDC or open circuit
Module Off < 1.8Vdc.
Shutdown Idle 10mA
Control Common referenced to input minus
7. Suffix "S" to the model number with SMD packages.
8. Maximum case temperature under any operating condition should not be exceeded 95°C (Plastic Case), 100°C (Copper Case).

EC4AW SERIES

3.3-6 WATT, 4:1 INPUT

Features

- ◆ 3.3W-6W Isolated Output
- ◆ DIP-24/SMD Package
- ◆ Efficiency to 83%
- ◆ 4 : 1 Input Range
- ◆ Regulated Outputs
- ◆ Pi Input Filter
- ◆ Continuous Short Circuit Protection
- ◆ Without Tantalum Capacitor Inside

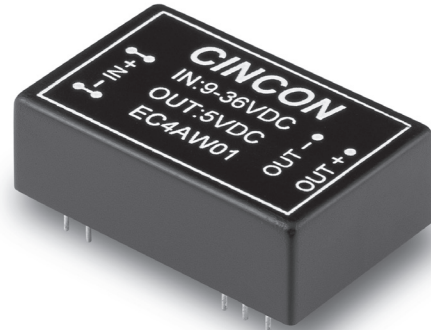

Mechanical Dimensions

NOTE: Pin Size is 0.02±0.002 Inch (0.5±0.05 mm) DIA
 All Dimensions in Inches (mm)
 Tolerance Inches: X.XX±0.02, X.XXX±0.010
 Millimeters: X.X±0.5, X.XX±0.25

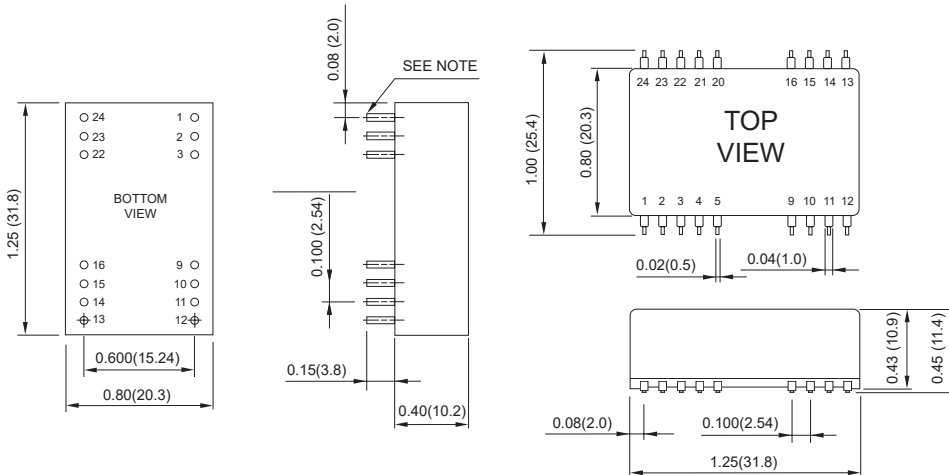

PIN CONNECTION				
Pin	Single Output		Dual Output	
	DIP	SMD	DIP	SMD
1,2,4	NP	NC	NP	NC
2,3	-V Input		-V Input	
4,5	NP	NC	NP	NC
9	NC		Common	
10,15	NC		NC	
11	NC		-V Output	
12,13	NP	NC	NP	NC
14	+V Output		+V Output	
16	-V Output		Common	
20,21	NP	NC	NP	NC
22,23	+V Input		+V Input	

* NC-NO CONNECTION WITH PIN
 * NP-NO PIN

MODEL NUMBER	INPUT VOLTAGE	OUTPUT VOLTAGE	OUTPUT CURRENT	INPUT CURRENT		% EFF.		CAPACITOR LOAD MAX.
				NO LOAD	FULL LOAD	(2)	(3)	
EC4AW01	9-36 VDC	5 VDC	1000 mA	5 mA	254 mA	84	82	1000µF
EC4AW02	9-36 VDC	12 VDC	470 mA	5 mA	283 mA	85	83	470µF
EC4AW03	9-36 VDC	15 VDC	400 mA	5 mA	301 mA	85	83	400µF
EC4AW04	9-36 VDC	±12 VDC	±230 mA	7.5 mA	280 mA	85	82	230µF
EC4AW05	9-36 VDC	±15 VDC	±190 mA	7.5 mA	293 mA	85	81	190µF
EC4AW06	9-36 VDC	±5 VDC	±500 mA	5 mA	251 mA	85	83	500µF
EC4AW07	9-36 VDC	3.3 VDC	1000 mA	5 mA	176 mA	80	78	1000µF
EC4AW11	18-72 VDC	5 VDC	1000 mA	5 mA	132 mA	83	79	1000µF
EC4AW12	18-72 VDC	12 VDC	470 mA	5 mA	143 mA	86	82	470µF
EC4AW13	18-72 VDC	15 VDC	400 mA	5 mA	154 mA	86	81	400µF
EC4AW14	18-72 VDC	±12 VDC	±230 mA	7.5 mA	143 mA	85	80	230µF
EC4AW15	18-72 VDC	±15 VDC	±190 mA	7.5 mA	148 mA	85	80	190µF
EC4AW16	18-72 VDC	±5 VDC	±500 mA	5 mA	130 mA	84	80	500µF
EC4AW17	18-72 VDC	3.3 VDC	1000 mA	5 mA	93 mA	79	74	1000µF

NOTE:
 1. Nominal Input Voltage: 24 or 48 VDC.
 2. Measured at 12VDC for 24Vin, 24VDC for 48Vin.
 3. Measured at Nominal Input Voltage.

Derating Curve

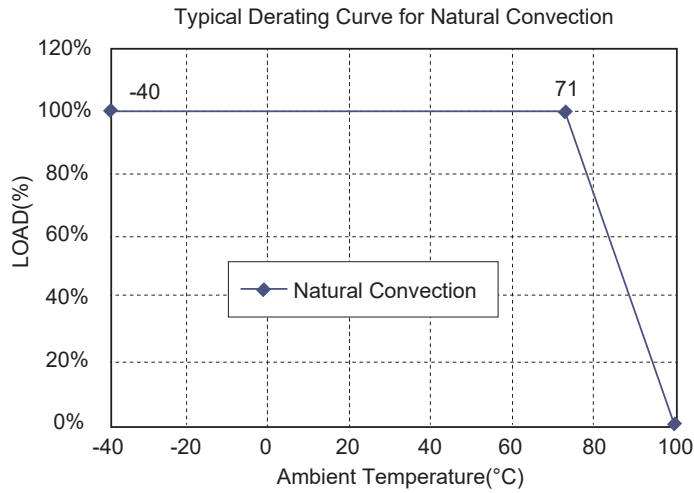

Specification

All Specifications Typical At Nominal Line, Full Load, and 25°C Unless Otherwise Noted

INPUT SPECIFICATIONS

Input Voltage Range	24V 9-36V 48V 18-72V
Input Filter	Pi Type

ISOLATION VOLTAGE

1.5K VDC min.	Standard or Suffix "HM" Models
3K VDC min. (note 4)	Suffix "H" Models

OUTPUT SPECIFICATIONS

Voltage Accuracy	±2.0% max.
Voltage Balance (Dual)	±1.0% max.
Temperature Coefficient	±0.05%/°C
Ripple & Noise, 20MHz BW	100mV pk-pk max.
Short Circuit Protection	Continuous
Line Regulation Single/Dual (note 1)	±0.5% max.
Load Regulation Single (note 2)	±0.5% max.
Dual (note 3)	±1.0% max.
Start up time	30 ms typ.

CASE MATERIAL

Standard Models	Non-Conductive Black Plastic
Suffix "HM" Models (note 5)	Black Coated Copper with Non-conductive Base

NOTE

1. Measured from high line to low line.
2. Measured from full load to 10% load.
3. Measured from full load to 1/4 load.
4. Non-conductive black plastic only.
5. Suffix "S" to the model number with SMD packages.
6. Maximum case temperature under any operating condition should not be exceeded 100°C.

GENERAL SPECIFICATIONS

Efficiency	See Table
Isolation Resistance	10 ⁹ ohm min.
Switching Frequency	200KHz min.
Operating Ambient Temperature Range	-40°C to +85°C
De-rating, Above 71°C	Linearly to Zero power at 100°C
Case Temperature	100°C max
Cooling	Natural Convection
Storage Temperature Range	-40°C to +100°C
Dimensions	DIP 1.25 x 0.80 x 0.40 inches (31.8 x 20.3 x 10.2 mm)
	SMD 1.25 x 0.80 x 0.45 inches (31.8 x 20.3 x 11.4 mm)
Weight	12.5 g

EC4AW-H6 SERIES

5-6 WATT, 6000 VDC ISOLATION

Features

- ◆ 5-6W Isolated Output
- ◆ DIP-24 Package
- ◆ Regulated Outputs
- ◆ Efficiency to 85%
- ◆ Continuous Short Circuit Protection
- ◆ I/O Isolation Voltage 6000VDC
- ◆ Reinforced Insulation Rated For Working Voltage 300VAC
- ◆ 5µA Leakage Current
- ◆ EMI Meets EN55022 Class A
- ◆ Safety Meets UL60950-1 and UL60601-1

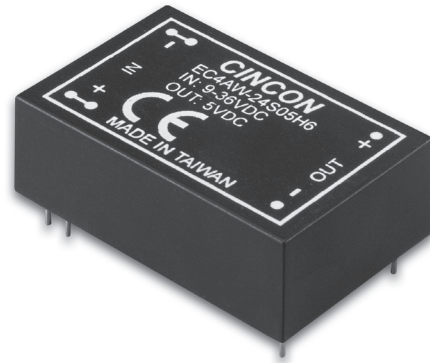

Mechanical Dimensions

NOTE: Pin Size is 0.02±0.002 Inch (0.5±0.05 mm) DIA
 All Dimensions in Inches (mm)
 Tolerance Inches: X.XX=±0.02, X.XXX=±0.010
 Millimeters: X.X=±0.5, X.XX=±0.25

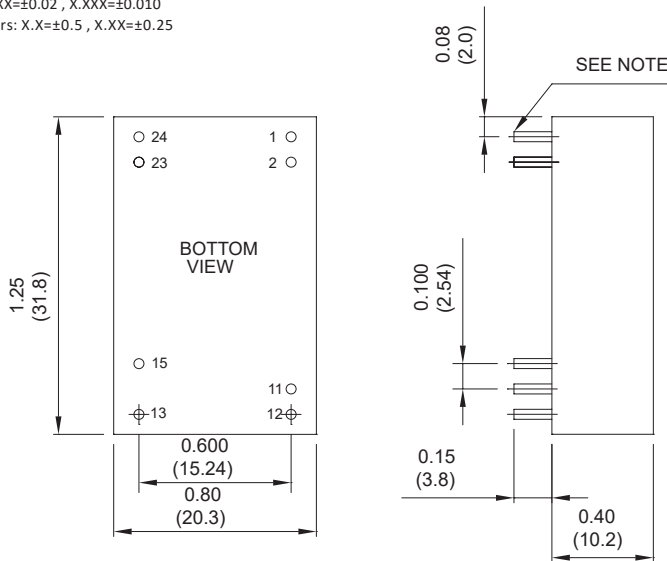

PIN CONNECTION		
PIN	Single Output	Dual Output
1	+V Input	+V Input
2	+V Input	+V Input
11	NP	Common
12	-V Output	NP
13	+V Output	-V Output
15	NP	+V Output
23	-V Input	-V Input
24	-V Input	-V Input

* NP-NO PIN
 * NC-NO CONNECTION WITH PIN

MODEL NUMBER	INPUT VOLTAGE	OUTPUT VOLTAGE	OUTPUT CURRENT		INPUT CURRENT		% EFF.		CAPACITOR LOAD MAX.
			MIN.(4)	MAX.	NO LOAD	FULL LOAD	(2)	(3)	
EC4AW-24S05H6	9-36 VDC	5 VDC	100 mA	1000 mA	10 mA	260 mA	81	80	1000µF
EC4AW-24S12H6	9-36 VDC	12 VDC	50 mA	500 mA	10 mA	295 mA	85.5	85	500µF
EC4AW-24D12H6	9-36 VDC	±12 VDC	25 mA	±250 mA	15 mA	298 mA	84.5	84	250µF
EC4AW-24D15H6	9-36 VDC	±15 VDC	20 mA	±200 mA	15 mA	298 mA	84.5	84	200µF
EC4AW-48S05H6	18-72 VDC	5 VDC	100 mA	1000 mA	5 mA	130 mA	81	80	1000µF
EC4AW-48S12H6	18-72 VDC	12 VDC	50 mA	500 mA	5 mA	149 mA	85	84	500µF
EC4AW-48D12H6	18-72 VDC	±12 VDC	25 mA	±250 mA	8 mA	150 mA	84	83	250µF
EC4AW-48D15H6	18-72 VDC	±15 VDC	20 mA	±200 mA	8 mA	149 mA	85	84	200µF

NOTE:

1. Nominal Input Voltage 24 or 48VDC
2. Measured at 12VDC for 24Vin Models, 24VDC for 48Vin Models
3. Measured at Nominal Input Voltage
4. Operation Under Minimum Load Will not Damage The Converter, but It May not Meet All Specifications

Derating Curve

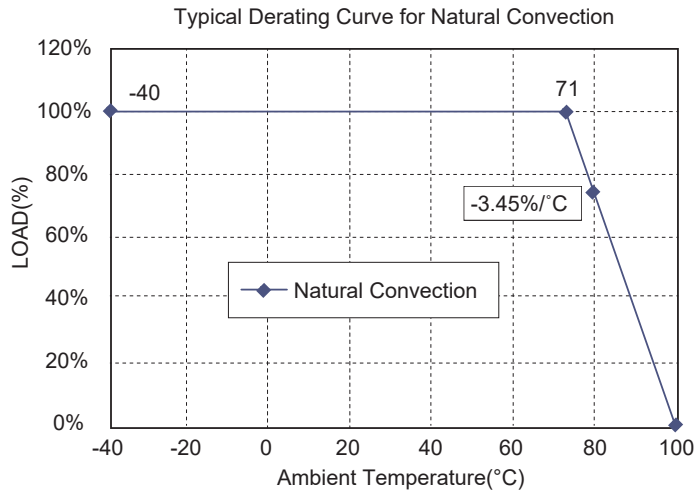

Specification

All Specifications Typical At Nominal Line, Full Load, and 25°C Unless Otherwise Noted

INPUT SPECIFICATIONS

Input Voltage Range	24Vin 9-36V 48Vin 18-72V
Under Voltage Protection	24Vin power up 8.8V typ. 24Vin power down 8V typ. 48Vin power up 17V typ. 48Vin power down .. 16V typ.
Leakage Current	5uA max.
Input Filter	Pi Type
Input Surge (100ms max.)	24Vin 50V max. 48Vin 100V max.

OUTPUT SPECIFICATIONS

Voltage Accuracy	±1.5% max.
Voltage Balance (Dual)	±2.0% max.
Transient Response: 75% - 100% Step Load Change	
Error Band	±6% Vout nominal
Recovery Time	< 500µs
Ripple & Noise, 20MHz BW (with 0.1uF MLCC)	5V 100mV pk-pk max. 12V/15V 1% pk-pk max.
Temperature Coefficient	±0.05%/°C
Line Regulation (note 1)	±0.5% max.
Load Regulation	Single (note 2) ±0.5% max. Dual (note 3) ±1.0% max.
Cross Regulation(Dual output)	
Load cross variation 25%/100%	±5% max.
Output Short Circuit Protection	Continuous
Start up time	1.5ms typ.

GENERAL SPECIFICATIONS

Efficiency	See Table
Isolation Voltage	6000VDC min.
Isolation Resistance	10 ⁹ ohm min.
Isolation Capacitance	40pF typ.
Reinforced Insulation	Creepage Distances8mm min. Air Clearances8mm min.
Switching Frequency	100KHz min.
Operating Ambient Temperature	-40°C to +71°C
De-rating, Above 71°C	Linearly to Zero power at 100°C
Case Temperature (note 4)	100°C max.
Storage Temperature	-40°C to +100°C
EMI	Conductive EMI Meet EN55022 Class A
Humidity	95% RH max. Non condensing
MTBF	MIL-HDBK-217-F, GB, 25°C, Full Load 1430Khrs typ.
Dimensions	1.25 x 0.80 x 0.40 inches
Case Material	(31.8 x 20.3 x 10.2 mm) Non-Conductive Black Plastic
Weight	13.1g

NOTE

1. Measured from high line to low line.
2. Measured from full load to 10% load.
3. Measured from full load to 25% load.
4. Maximum case temperature under any operating condition should not be exceeded 100°C.

EC5A SERIES

6-24 WATT, NON-ISOLATION

Features

- ◆ 6-24W Non-Isolated Output
- ◆ DIP-24/SMD Package
- ◆ Efficiency to 94%
- ◆ Regulated Outputs
- ◆ Input LC Filter



Mechanical Dimensions

NOTE: Pin Size is 0.02±0.002 Inch (0.5±0.05 mm) DIA
 All Dimensions in Inches (mm)
 Tolerance Inches: X.XX±0.02, X.XXX±0.010
 Millimeters: X.X±0.5, X.XX±0.25

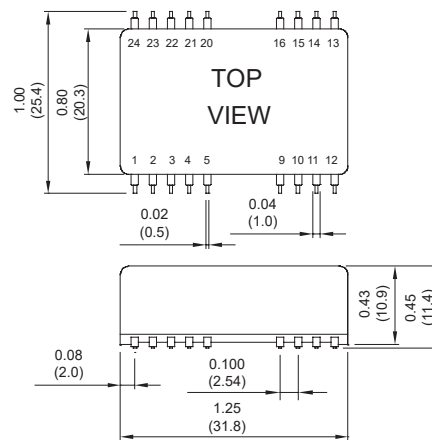
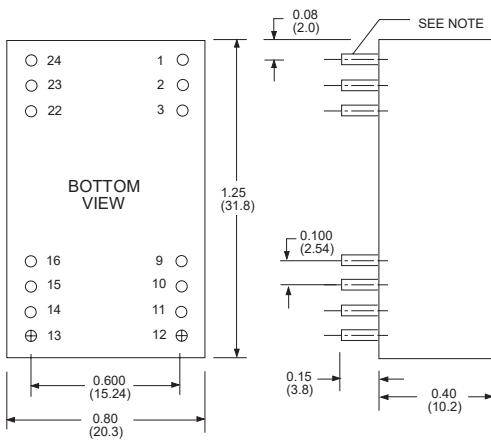

PIN CONNECTION		
PIN	Function	
	DIP	SMD
1,24	NP	NC
2,3	-V Input	
4,5	NP	NC
9,16	-V Output	
10,15	NC	
11,14	+V Output	
12,13	NP	NC
20,21	NP	NC
22,23	+V Input	

* NP-NO PIN
 * NC-NO CONNECTION WITH PIN

MODEL NUMBER	INPUT VOLTAGE	OUTPUT VOLTAGE	OUTPUT CURRENT	INPUT CURRENT		% EFF	CASE
				NO LOAD	FULL LOAD		
EC5A-05S33	4.7-6 VDC	3.3 VDC	2000 mA	15 mA	1553 mA	85	DIP-24
EC5A-12S33	9-32 VDC	3.3 VDC	2000 mA	15 mA	655 mA	84	DIP-24
EC5A-12S05	9-32 VDC	5 VDC	2000 mA	15 mA	947 mA	88	DIP-24
EC5A-12S12	9-32 VDC	12 VDC	830 mA	15 mA	954 mA	87	DIP-24
EC5A-12S15	9-32 VDC	15 VDC	666 mA	15 mA	957 mA	87	DIP-24
EC5A-24S12	16-32 VDC	12 VDC	1600 mA	15 mA	860 mA	93	DIP-24
EC5A-24S15	19-32 VDC	15 VDC	1600 mA	15 mA	1064 mA	94	DIP-24

NOTE: 1. Nominal Input Voltage: 5, 12 or 24 VDC

Derating Curve

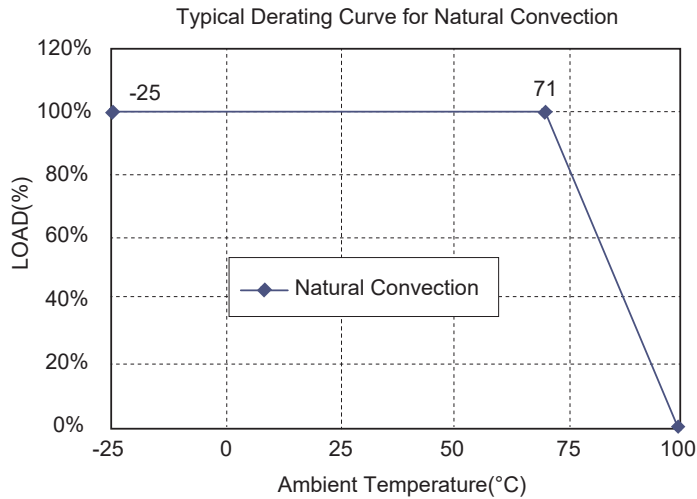

Specification

All Specifications Typical At Nominal Line, Full Load, and 25°C Unless Otherwise Noted

INPUT SPECIFICATIONS

Input Voltage Range	5.0V 4.7-6V
	12V 9-32V
	24V 16-32V
	24V 19-32V
Input Filter	LC Type

OUTPUT SPECIFICATIONS

Voltage Accuracy	±2.0% max.
Temperature Coefficient	±0.05%/°C
Ripple & Noise, 20MHz BW	3.3V/5V.....100mV pk-pk max.
	12V/15V.....1% pk-pk max.
Over Current Protection	120- 160%
Line Regulation (note 1)	±0.5% max.
Load Regulation (note 2)	±0.5% max.

GENERAL SPECIFICATIONS

EEfficiency	See Table
Switching Frequency	150KHz typ.
Isolation Voltage (Input/Output)	Non-Isolation
Operating Ambient Temperature Range	-25°C to +71°C
De-rating, Above 71°C	Linearly to Zero power at 100°C
Case Temperature (note 4)	100°C max.
Cooling	Natural Convection
Storage Temperature Range	-40°C to +100°C
Dimensions	DIP
	SMD
Weight	17.8 g
Case Material	Black Coated Copper with Non-conductive Base

NOTE

1. Measured from high line to low line.
2. Measured from full load to 10% load.
3. Suffix "S" to the model number with SMD packages.
4. Maximum case temperature under any operating condition should not be exceeded 100°C.

EC6A SERIES

7.5 WATT, 2:1 INPUT RANGE

Features

- ◆ 7.5W Isolated Output
- ◆ 24-Pin DIP Package
- ◆ Efficiency to 87%
- ◆ 2 : 1 Input Range
- ◆ Regulated Outputs
- ◆ Pi Input Filter
- ◆ Continuous Short Circuit Protection
- ◆ CE Mark Meets 2004/108/EC
- ◆ UL60950-1 Approval
- ◆ Without Tantalum Capacitor Inside

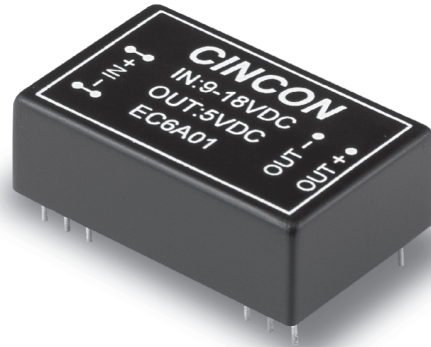

Mechanical Dimensions

NOTE: Pin Size is 0.02±0.002 Inch (0.5±0.05 mm) DIA
 All Dimensions in Inches (mm)
 Tolerance Inches: X.XX±0.02, X.XXX±0.010
 Millimeters: X.X±0.5, X.XX±0.25

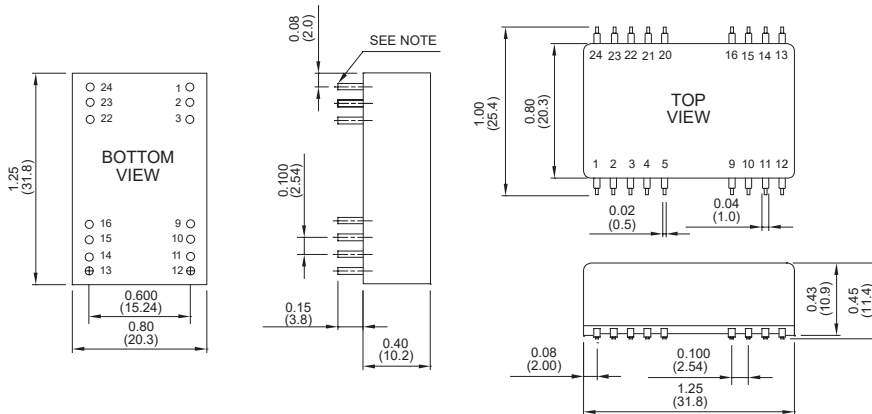

Pin	PIN CONNECTION			
	Single Output		Dual Output	
	DIP	SMD	DIP	SMD
1,24	NP	NC	NP	NC
2,3	-V Output		-V Output	
4,5	NP	NC	NP	NC
9	NC		Common	
10,15	NC		NC	
11	NC		-V Output	
12,13	NP	NC	NP	NC
14	+V Output		+V Output	
16	-V Output		Common	
20,21	NP	NC	NP	NC
22,23	+V Input		+V Input	

* NP-NO PIN
 * NC-NO CONNECTION WITH PIN

MODEL NUMBER	INPUT VOLTAGE	OUTPUT VOLTAGE	OUTPUT CURRENT		INPUT CURRENT		% EFF.	CAPACITOR LOAD MAX.
			MIN.	MAX.	NO LOAD	FULL LOAD		
EC6A01	9-18 VDC	5 VDC	0 mA	1500 mA	25 mA	781 mA	80	4700µF
EC6A02	9-18 VDC	12 VDC	0 mA	625 mA	25 mA	753 mA	83	4700µF
EC6A03	9-18 VDC	15 VDC	0 mA	500 mA	25 mA	744 mA	84	4700µF
EC6A04	9-18 VDC	±5 VDC	0 mA	±750 mA	30 mA	772 mA	81	2200µF
EC6A05	9-18 VDC	±12 VDC	0 mA	±310 mA	30 mA	753 mA	83	2200µF
EC6A06	9-18 VDC	±15 VDC	0 mA	±250 mA	30 mA	753 mA	83	2200µF
EC6A07	9-18 VDC	3.3 VDC	0 mA	1500 mA	25 mA	529 mA	78	4700µF
EC6A11	18-36 VDC	5 VDC	0 mA	1500 mA	20 mA	377 mA	83	4700µF
EC6A12	18-36 VDC	12 VDC	0 mA	625 mA	20 mA	359 mA	87	4700µF
EC6A13	18-36 VDC	15 VDC	0 mA	500 mA	20 mA	359 mA	87	4700µF
EC6A14	18-36 VDC	±5 VDC	0 mA	±750 mA	25 mA	372 mA	84	2200µF
EC6A15	18-36 VDC	±12 VDC	0 mA	±310 mA	25 mA	356 mA	87	2200µF
EC6A16	18-36 VDC	±15 VDC	0 mA	±250 mA	25 mA	372 mA	84	2200µF
EC6A17	18-36 VDC	3.3 VDC	0 mA	1500 mA	20 mA	264 mA	78	4700µF
EC6A21	36-72 VDC	5 VDC	0 mA	1500 mA	10 mA	193 mA	81	4700µF
EC6A22	36-72 VDC	12 VDC	0 mA	625 mA	10 mA	184 mA	85	4700µF
EC6A23	36-72 VDC	15 VDC	0 mA	500 mA	10 mA	182 mA	86	4700µF
EC6A24	36-72 VDC	±5 VDC	0 mA	±750 mA	15 mA	191 mA	82	2200µF
EC6A25	36-72 VDC	±12 VDC	0 mA	±310 mA	15 mA	182 mA	85	2200µF
EC6A26	36-72 VDC	±15 VDC	0 mA	±250 mA	15 mA	184 mA	85	2200µF
EC6A27	36-72 VDC	3.3 VDC	0 mA	1500 mA	10 mA	136 mA	76	4700µF

NOTE: 1. Nominal Input Voltage: 12, 24 or 48VDC

Derating Curve

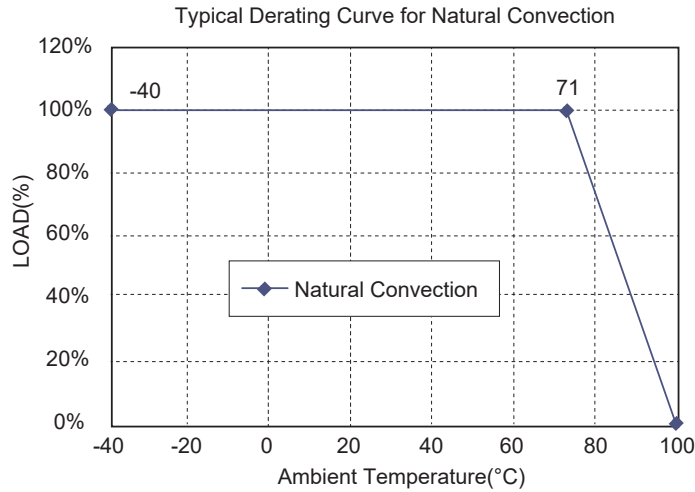

Specification

All Specifications Typical At Nominal Line, Full Load, and 25°C Unless Otherwise Noted

INPUT SPECIFICATIONS

Input Voltage Range	12V 9-18V
	24V 18-36V
	48V 36-72V
Input Surge Voltage (100ms max.)	12V 20Vdc max.
	24V 50Vdc max.
	48V 100Vdc max.
Input Filter	Pi Type

OUTPUT SPECIFICATIONS

Voltage Accuracy	±2.0% max.
Voltage Balance (Dual)	±1.0% max.
Temperature Coefficient	±0.05%/°C
Ripple & Noise, 20MHz BW	100mV pk-pk max.
Short Circuit Protection	Continuous
Line Regulation Single/Dual (note 1)	±0.2% max.
Load Regulation Single (note 2)	±0.5% max.
Dual (note 3)	±1.0% max.
Start up time	EC6A0XX 5ms typ.
	Other 20ms typ.

GENERAL SPECIFICATIONS

Efficiency	See Table
Isolation Resistance	10 ⁹ ohm min.
Isolation Capacitance	560pF typ.
Isolation Voltage	1500VDC min.
Switching Frequency	300KHz typ.
Operating Ambient Temperature Range	-40°C to +85°C
De-rating, Above 71°C	Linearly to Zero power at 100°C
Case Temperature (note 5)	100°C max.
Cooling	Natural Convection
Storage Temperature Range	-40°C to +100°C
Humidity	95% RH max. Non condensing
MTBF MIL-STD-217F, GB, 25°C, Full Load	1800Khrs typ.
Dimensions	DIP
	SMD
Weight	18.4g
Case Material	Black Coated Copper with Non-conductive Base

NOTE

1. Measured from high line to low line.
2. Measured from full load to 10% load.
3. Measured from full load to 1/4 load.
4. Suffix "S" to the model number with SMD packages.
5. Maximum case temperature under any operating condition should not be exceeded 100°C.

EC6AW SERIES

8 WATT, 4:1 INPUT RANGE

Features

- ◆ 8W Isolated Output
- ◆ DIP-24/SMD Package
- ◆ Efficiency to 86%
- ◆ 4 : 1 Input Range
- ◆ Regulated Outputs
- ◆ Input Under-Voltage Protection
- ◆ Remote On/Off
- ◆ Continuous Short Circuit Protection
- ◆ Without Tantalum Capacitors Inside
- ◆ Safety Meets UL60950-1, EN60950-1, and IEC60950-1
- ◆ Meets EN50155 with External Circuits
- ◆ Shock & Vibration Meets EN50155 (EN61373)

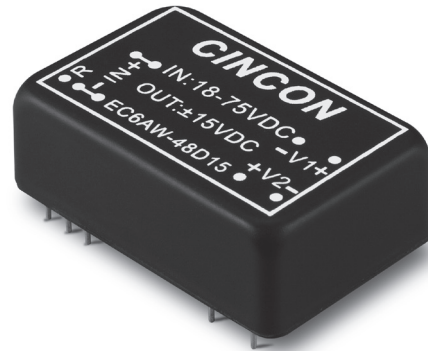

Mechanical Dimensions

NOTE: Pin Size is 0.02±0.002 Inch (0.5±0.05 mm) DIA
 All Dimensions in Inches (mm)
 Tolerance Inches: X.XX±0.02, X.XXX±0.010
 Millimeters: X.X±0.5, X.XX±0.25

DIP Packages

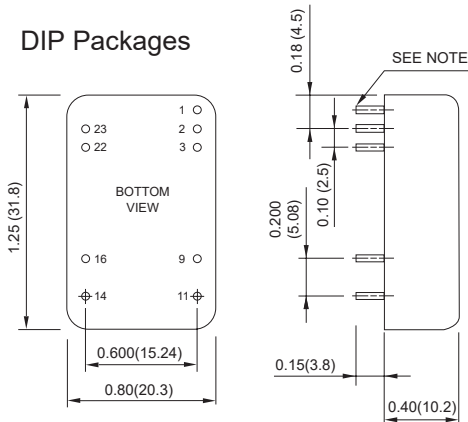

SMD Packages

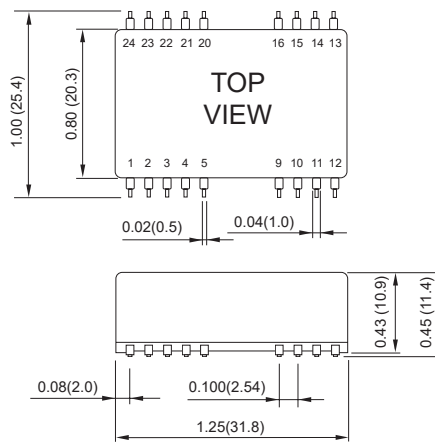

Pin	PIN CONNECTION			
	Single Output		Dual Output	
	DIP	SMD	DIP	SMD
1	Remote on/off	Remote on/off	Remote on/off	Remote on/off
2,3	-V Input		-V Input	
4,5	NP	NC	NP	NC
9	NP	NC	Common	
10	NP	NC	NP	NC
11	NC		-V Output	
12	NP	NC	NP	NC
13	NP	+V Output	NP	NC
14	+V Output		+V Output	
15	NP	-V Output	NP	NC
16	-V Output		Common	
20,21,24	NP	NC	NP	NC
22,23	+V Input		+V Input	

* NC-NO CONNECTION WITH PIN
 * NP-NO PIN

MODEL NUMBER	INPUT VOLTAGE	OUTPUT VOLTAGE	OUTPUT CURRENT		INPUT CURRENT		% EFF.	CAPACITOR LOAD MAX.
			MIN.	MAX.	NO LOAD	FULL LOAD		
EC6AW-24S33	9-36 VDC	3.3 VDC	0 mA	2000 mA	10 mA	344 mA	80	2000µF
EC6AW-24S05	9-36 VDC	5 VDC	0 mA	1600 mA	10 mA	406 mA	82	1600µF
EC6AW-24S12	9-36 VDC	12 VDC	0 mA	666 mA	10 mA	392 mA	85	666µF
EC6AW-24S15	9-36 VDC	15 VDC	0 mA	530 mA	10 mA	390 mA	85	530µF
EC6AW-24D05	9-36 VDC	±5 VDC	0 mA	±800 mA	10 mA	406 mA	82	800µF
EC6AW-24D12	9-36 VDC	±12 VDC	0 mA	±333 mA	10 mA	392 mA	85	333µF
EC6AW-24D15	9-36 VDC	±15 VDC	0 mA	±265 mA	10 mA	390 mA	85	265µF
EC6AW-48S33	18-75 VDC	3.3 VDC	0 mA	2000 mA	5 mA	172 mA	80	2000µF
EC6AW-48S05	18-75 VDC	5 VDC	0 mA	1600 mA	5 mA	201 mA	83	1600µF
EC6AW-48S12	18-75 VDC	12 VDC	0 mA	666 mA	5 mA	194 mA	86	666µF
EC6AW-48S15	18-75 VDC	15 VDC	0 mA	530 mA	5 mA	193 mA	86	530µF
EC6AW-48D05	18-75 VDC	±5 VDC	0 mA	800 mA	5 mA	201 mA	83	800µF
EC6AW-48D12	18-75 VDC	±12 VDC	0 mA	±333 mA	5 mA	194 mA	86	333µF
EC6AW-48D15	18-75 VDC	±15 VDC	0 mA	±265 mA	5 mA	193 mA	86	265µF

NOTE: 1. Nominal Input Voltage 24 or 48 VDC

Derating Curve

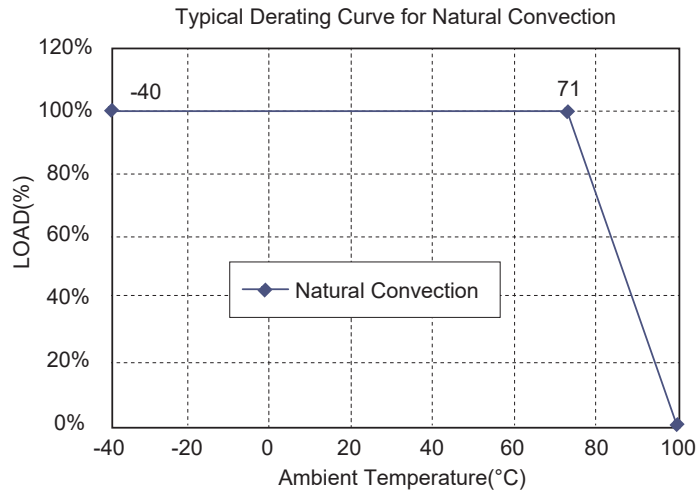

Specification

All Specifications Typical At Nominal Line, Full Load, and 25°C Unless Otherwise Noted

INPUT SPECIFICATIONS

Input Voltage Range	24V 9-36V
	48V 18-75V
Input Surge Voltage (100ms max.)	24V 50Vdc max.
	48V 100Vdc max.
Under voltage lockout	24Vin
	48Vin
	power up.....8.8V typ.
	power down.....8.0V typ.
	power up..... 17V typ.
	power down..... 16V typ.
Input Filter	PI Type
Positive Logic Remote on/off Control (note 3):	
Logic Compatibility	CMOS or Open Collector
	TTL, ref. to -Vin
Module On	>+3.5V to 36VDC or Open
Module Off	Circuit
	0 to <1.2VDC

OUTPUT SPECIFICATIONS

Voltage Accuracy	±1.5% max.
Voltage Balance (Dual)	±1.0% max.
Transient Response: 75% - 100% Step Load Change	
Error Band	±5% Vout nominal,
Recovery Time	< 500µs
Ripple & Noise, 20MHz BW (with 0.1µF MLCC)	
Vo=3.3 & 5V	75mV pk-pk max.
Vo=12 & 15V	100mV pk-pk max.
Temperature Coefficient	±0.03%/°C max.
Short Circuit Protection	Continuous
Line Regulation (note1)	±0.5% max.
Load Regulation (note2)	±0.5% max.
	±1.0% max.
Cross Regulation (Dual output)	
Load cross variation 25%/100%	±5% max.
Over Voltage Protection	Zener or TVS Clamp
Start up time	3.5ms typ.

GENERAL SPECIFICATIONS

Efficiency	See Table
Isolation Voltage	1500 VDC min.
Isolation Resistance	10 ⁹ ohms min.
Isolation Capacitance	1000pF typ.
Switching Frequency	100KHz min.
Operating Ambient Temperature Range	-40°C to +85°C
Derating, Above 71°C	Linearly to Zero Power at +100°C
Case Temperature (note 5)	100°C
Cooling	Natural Convection
Storage Temperature Range	-55°C to +125°C
Humidity	95% RH max. Non condensing
MTBF	MIL-HDBK-217F, GB, 25°C, Full Load
	Single
	Dual
EMC	1500Khrs typ.
	1300Khrs typ.
	Meets EN50155(EN50121-3-2)
	with external filter
	Meets EN50155(EN61373)
Shock/Vibration	
Dimensions	DIP
	SMD
	1.25 x 0.80 x 0.40 inches
	(31.8 x 20.3 x 10.2 mm)
	1.25 x 0.80 x 0.45 inches
	(31.8 x 20.3 x 11.4 mm)
Case Material	Black Coated Copper with Non-Conductive Base
Weight	18.4 g

NOTE

1. Measured from high line to low line.
2. Measured from full load to min. load.
3. Suffix "N" to the model number with negative logic remote On/Off

Module On	0 to <1.2VDC
Module Off	>+3.5VDC to 36VDC or open circuit
4. Suffix "S" to the model number with SMD package.
5. Maximum case temperature under any operating condition should not be exceeded 100°C.

EC6AW-110 SERIES

10 WATT 4:1 INPUT DC-DC CONVERTERS

Features

- ◆ 8.25-10W Isolated Output
- ◆ Efficiency to 88.5%
- ◆ Low No Load Power Consumption
- ◆ 4:1 Input Range
- ◆ Regulated Outputs
- ◆ Input Under-Voltage Protection
- ◆ Remote On/Off
- ◆ Continuous Short Circuit Protection
- ◆ Over Current Protection
- ◆ All Ceramic Capacitor Design
- ◆ UL60950-1 2nd (Basic Insulation) Approval
- ◆ Meets EN50155 with External Circuits
- ◆ Shock & Vibration Meets EN50155 (EN61373)
- ◆ Fire & Smoke Meets EN45545-2
- ◆ 3050m Operating Altitude



Mechanical Dimensions

NOTE: Pin Size is 0.02±0.002 Inch (0.5±0.05 mm) DIA
 All Dimensions In Inches (mm)
 Tolerances Inches: X.XX= ±0.02 , X.XXX= ±0.010
 Millimeters: X.X= ±0.5 , X.XX=±0.25

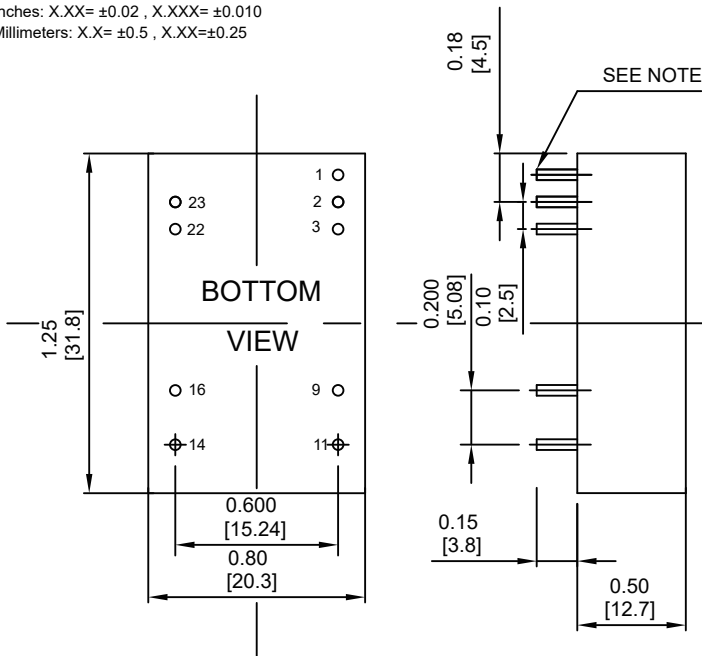

PIN CONNECTION		
PIN	Single Output	Dual Output
1	Remote On/Off	Remote On/Off
2,3	-V Input	-V Input
4,5	NP	NP
9	NP	Common
10	NP	NP
11	NC	-V Output
12	NP	NP
13	NP	NP
14	+V Output	+V Output
15	NP	NP
16	-V Output	Common
20,21,24	NP	NP
22,23	+V Input	+V Input

* NC-NO CONNECTION WITH PIN
 * NP-NO PIN

MODEL NUMBER	INPUT VOLTAGE	OUTPUT VOLTAGE	OUTPUT CURRENT		INPUT CURRENT		% EFF.	CAPACITOR LOAD MAX.
			MIN.	MAX.	NO LOAD	FULL LOAD		
EC6AW-110S33	43-160 VDC	3.3 VDC	0 mA	2500 mA	6 mA	89 mA	85	2500uF
EC6AW-110S05	43-160 VDC	5 VDC	0 mA	2000 mA	6 mA	105 mA	87	2000uF
EC6AW-110S12	43-160 VDC	12 VDC	0 mA	835 mA	6 mA	104 mA	88	835uF
EC6AW-110S15	43-160 VDC	15 VDC	0 mA	666 mA	6 mA	103 mA	88.5	666uF
EC6AW-110D05	43-160 VDC	±5 VDC	0 mA	±1000 mA	6 mA	107 mA	85	1000uF
EC6AW-110D12	43-160 VDC	±12 VDC	0 mA	±416 mA	6 mA	105 mA	87	416uF
EC6AW-110D15	43-160 VDC	±15 VDC	0 mA	±333 mA	6 mA	104 mA	87.5	333uF

NOTE:
 1. Nominal Input Voltage 110 VDC

Derating Curve

Typical Derating Curve of Natural Convection

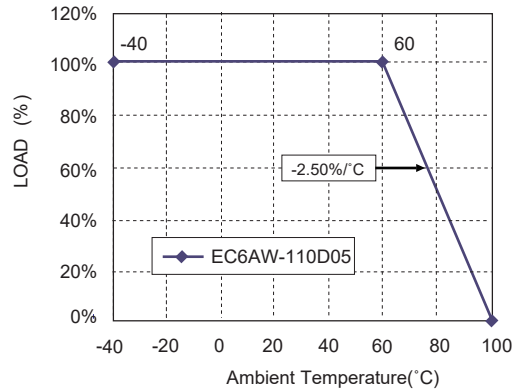

Specifications

All Specifications Typical At Nominal Line, Full Load, and 25°C Unless Otherwise Noted

INPUT SPECIFICATIONS

Input Voltage Range	110V.....43-160V
Input Surge Voltage (100ms max.)	200Vdc max.
Under Voltage Lockout	Power up.....40V
	Power down.....38V
Positive Logic Remote On/Off	see note 3&4
Input Filter	PI Type

OUTPUT SPECIFICATIONS

Voltage Accuracy:	±1.0% max.
Voltage Balance (Dual Output)	±2.0% max.
Transient Response: 75% - 100% Step Load Change	
Error Band	±5% Vout nominal
Recovery Time	< 250us
Ripple & Noise, 20MHz BW (Measured with 1uF MLCC)	
Vo=3.3V, 5V, ±5V	75mV pk-pk max.
Vo=12V, 15V, ±12V, ±15V	100mV pk-pk max.
Temperature Coefficient	±0.02%/°C max.
Short Circuit Protection	Continuous
Line Regulation (note 1)	±0.2% max.
Load Regulation (note 2)	
Single	±0.5% max.
Dual	±1.0% max.
Cross Regulation (Dual output)	±5.0% max.
Load cross variation 25%/100%	
Over Voltage Protection	Zener or TVS Clamp
Current Limit	110%-170% Nominal Output
Start up time	10ms typ.

GENERAL SPECIFICATIONS

Efficiency	See Table
Isolation Voltage	3000VDC min.
Isolation Resistance	10 ⁹ ohm min.
Isolation Capacitance	1000pF typ.
Switching Frequency	240KHz typ.
Operating Ambient Temperature Range	-40°C to +85°C
De-rating, Above 60°C	Vo=±5V
De-rating, Above 67°C (note 7)	Others
Case Temperature (note5)	Linearly to Zero Power at +100°C
Cooling	Natural Convection
Storage Temperature Range	-55°C to +125°C
Humidity	95% RH max. Non condensing
MTBF MIL-HDBK-217F, GB, 25°C, Full Load	1200Khrs typ.
Safety	Meets UL60950-1 2 nd (Basic insulation)
EMC (note6)	Meets EN50155(EN50121-3-2) with external filter
Shock/Vibration	Meets EN50155(EN61373)
Fire & Smoke	Meet EN45545-2
Dimensions	1.25x0.80x0.50 Inches (31.8x20.3x12.7mm)
Case Material	Non-Conductive Black Plastic
Weight	16g

NOTE

1. Measured from high line to low line.
2. Measured from full load to min. load.
3. Logic Compatibility ... CMOS or open collector TTL referenced to -Vin.
Module on >3.5VDC to 160VDC or open circuit
Module off 0 to <1.2VDC
4. Suffix "N" to the model number with negative logic remote on/off
Module on 0 to < 1.2Vdc
Module off >3.5VDC to 160VDC or open circuit
5. Maximum case temperature under any operating condition should not be exceeded 100°C.
6. For information about EN50155 and RIA12, refer to application note.
7. Others model refer to application note.

EC7A SERIES

10 WATT, 2:1 INPUT RANGE

Features

- ◆ 10W Isolated Output
- ◆ DIP-24 / SMD Package
- ◆ Very High Efficiency Up to 89%
- ◆ 2 : 1 Input Range
- ◆ Regulated Outputs
- ◆ PI Input Filter
- ◆ Continuous Short Circuit Protection
- ◆ No Tantalum Capacitor Inside
- ◆ CE Mark Meets 2004/108/EC
- ◆ UL60950-1 Approval

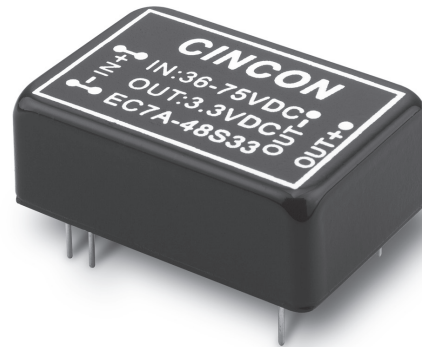

Mechanical Dimensions

NOTE: Pin Size is 0.02±0.002 Inch (0.5±0.05 mm) DIA
 All Dimensions in Inches (mm)
 Tolerance Inches: X.XX±0.02, X.XXX±0.010
 Millimeters: X.X±0.5, X.XX±0.25

DIP Packages

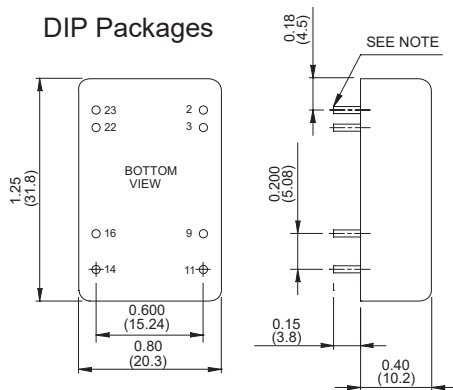

SMD Packages

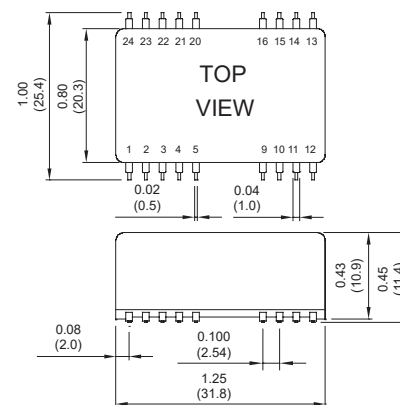

Pin	PIN CONNECTION			
	Single Output		Dual Output	
	DIP	SMD	DIP	SMD
1,24	NP	NC	NP	NC
2,3	-V Input		-V Input	
4,5	NP	NC	NP	NC
9	NP	NC	Common	
10	NP	NC	NP	NC
11	NC		-V Output	
12	NP	NC	NP	NC
13	NP	+V Output	NP	NC
14	+V Output		+V Output	
15	NP	-V Output	NP	NC
16	-V Output		Common	
20,21	NP	NC	NP	NC
22,23	+V Input		+V Input	

* NC-NO CONNECTION WITH PIN
 * NP-NO PIN

MODEL NUMBER	INPUT VOLTAGE	OUTPUT VOLTAGE	OUTPUT CURRENT		INPUT CURRENT		% EFF.	CAPACITOR LOAD MAX.
			MIN.	MAX.	NO LOAD	FULL LOAD		
EC7A-12S25	9-18 VDC	2.5 VDC	0 mA	3000 mA	40 mA	735 mA	85	3000µF
EC7A-12S33	9-18 VDC	3.3 VDC	0 mA	3000 mA	50 mA	971 mA	85	3000µF
EC7A-12S05	9-18 VDC	5 VDC	0 mA	2000 mA	60 mA	947 mA	88	2000µF
EC7A-12S12	9-18 VDC	12 VDC	0 mA	835 mA	40 mA	949 mA	88	835µF
EC7A-12S15	9-18 VDC	15 VDC	0 mA	666 mA	40 mA	946 mA	88	666µF
EC7A-12D12	9-18 VDC	±12 VDC	0 mA	±416 mA	30 mA	956 mA	87	416µF
EC7A-12D15	9-18 VDC	±15 VDC	0 mA	±333 mA	30 mA	968 mA	86	333µF
EC7A-24S25	18-36VDC	2.5 VDC	0 mA	3000 mA	30 mA	368 mA	85	3000µF
EC7A-24S33	18-36VDC	3.3 VDC	0 mA	3000 mA	30 mA	480 mA	86	3000µF
EC7A-24S05	18-36VDC	5 VDC	0 mA	2000 mA	30 mA	473 mA	88	2000µF
EC7A-24S12	18-36VDC	12 VDC	0 mA	835 mA	30 mA	469 mA	89	835µF
EC7A-24S15	18-36VDC	15 VDC	0 mA	666 mA	30 mA	473 mA	88	666µF
EC7A-24D12	18-36VDC	±12 VDC	0 mA	±416 mA	20 mA	467 mA	89	416µF
EC7A-24D15	18-36VDC	±15 VDC	0 mA	±333 mA	20 mA	478 mA	87	333µF
EC7A-48S25	36-75VDC	2.5 VDC	0 mA	3000 mA	15 mA	184 mA	85	3000µF
EC7A-48S33	36-75VDC	3.3 VDC	0 mA	3000 mA	15 mA	243 mA	85	3000µF
EC7A-48S05	36-75VDC	5 VDC	0 mA	2000 mA	15 mA	237 mA	88	2000µF
EC7A-48S12	36-75VDC	12 VDC	0 mA	835 mA	15 mA	235 mA	89	835µF
EC7A-48S15	36-75VDC	15 VDC	0 mA	666 mA	15 mA	237 mA	88	666µF
EC7A-48D12	36-75VDC	±12 VDC	0 mA	±416 mA	10 mA	236 mA	88	416µF
EC7A-48D15	36-75VDC	±15 VDC	0 mA	±333 mA	10 mA	242 mA	86	333µF

NOTE: 1. Nominal Input Voltage 12, 24, 48VDC

Derating Curve

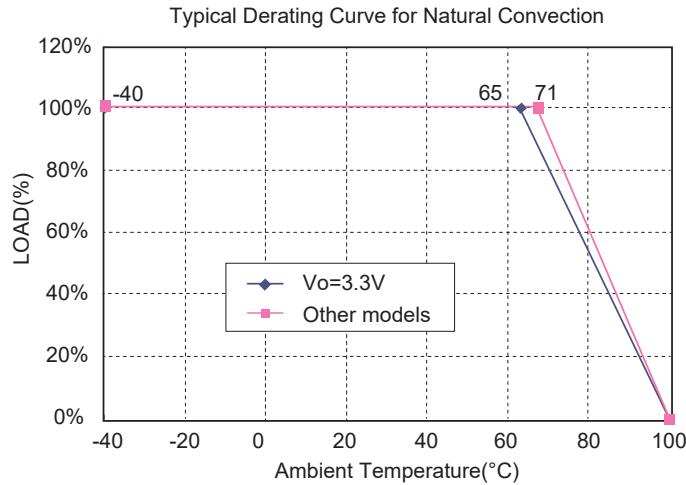

Specification

All Specifications Typical At Nominal Line, Full Load, and 25°C Unless Otherwise Noted

INPUT SPECIFICATIONS

Input Voltage Range	12V	9-18V
	24V	18-36V
	48V	36-75V
Input Surge Voltage (100ms max.)	12V	25Vdc max.
	24V	50Vdc max.
	48V	100Vdc max.
Under voltage lockout	12Vin	power up 8.8V
		power down 8V
	24Vin	power up 17V
		power down 16V
	48Vin	power up 34V
		power down 32V
Input Filter		PI Type

OUTPUT SPECIFICATIONS

Voltage Accuracy		±1.5% max.
Voltage Balance (Dual)		±2.0% max.
Transient Response: 75% - 100% Step Load Change		
	Error Band	±5% Vout Nominal
	Recovery Time	< 300µs
Ripple & Noise, 20MHz BW	Single	75mV pk-pk, max.
	Dual	100mV pk-pk, max.
Temperature Coefficient		±0.05%/°C
Line Regulation (note1)	Single	±0.2% max.
	Dual	±0.5% max.
Load Regulation (note2)	Single	DIP±0.5% max., SMD±1.0% max.
	Dual	±1.0% max.
Output Short Circuit Protection		Continuous
Over voltage Protection (Zener Diode Clamp, Single Output Only)		
		2.5V, 3.3V.....3.9Vdc typ.
		5V.....6.2Vdc typ.
		12V.....15Vdc typ.
		15V.....18Vdc typ.
Start up time		24(48)S25(33).....120ms typ.
		24(48)S05(12).....60ms typ.
Others		8ms typ.

GENERAL SPECIFICATIONS

Efficiency		See Table
Isolation Voltage		Input/Output 1500VDC min.
Isolation Resistance		10 ⁹ ohm min.
Isolation Capacitance		1000pF typ.
Switching Frequency		380KHz typ.
Operating Ambient Temperature		-40°C to +85°C
De-rating, Above 71°C		Linearly to Zero power at 100°C
Case Temperature (note 4)		100°C max.
Cooling		Natural Convection
Storage Temperature		-40°C to +125°C
Humidity		95% RH max. Non condensing
MTBF.....MIL-STD-217F, GB, 25°C Full Load		XXS33/05 960Khrs typ.
		Others 125Khrs typ.
Dimensions	DIP	1.25 x 0.80 x 0.40 inches (31.8 x 20.3 x 10.2 mm)
Case Material		Black Coated Copper with Non-Conductive Base
Weight		18 g

NOTE

1. Measured from high line to low line.
2. Measured from full load to min. load.
3. Measured with 0.1µF MLCC.
4. Maximum case temperature under any operating condition should not be exceeded 105°C.

EC8AW SERIES

15 WATT, 4:1 INPUT RANGE

Features

- ◆ 15W Isolated Output
- ◆ DIP-24 Metal Package
- ◆ Very High Efficiency Up to 90%
- ◆ Low No Load Power Consumption
- ◆ 4 : 1 Input Range
- ◆ Regulated Outputs
- ◆ Conductive EMI Meet EN55022 Class A Without External Components
- ◆ Continuous Short Circuit Protection
- ◆ No Tantalum Capacitor Inside
- ◆ CE Mark Meets 2004/108/EC
- ◆ Safety Meets UL60950-1, EN60950-1 and IEC60950-1

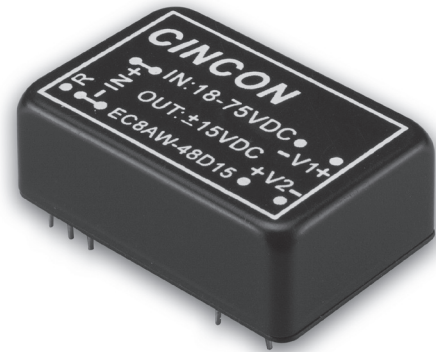

Mechanical Dimensions

NOTE: Pin Size is 0.02±0.002 Inch (0.5±0.05 mm) DIA
 All Dimensions in Inches (mm)
 Tolerance Inches: X.XX±0.02, X.XXX±0.010
 Millimeters: X.X±0.5, X.XX±0.25

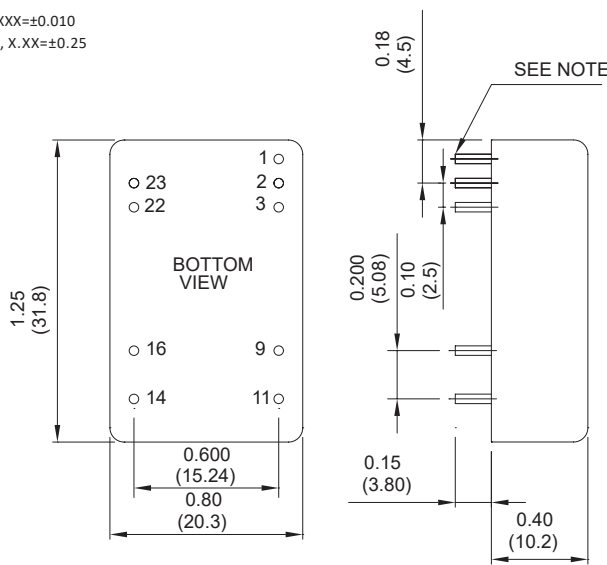

PIN CONNECTION		
Pin	Single Output	Dual Output
1	Remote On/Off	Remote On/Off
2,3	-V Input	-V Input
4,5	NP	NP
9	NP	Common
10	NP	NP
11	NC	-V Output
12	NP	NP
13	NP	NP
14	+V Output	+V Output
15	NP	NP
16	-V Output	Common
20,21,24	NP	NP
22,23	+V Input	+V Input

* NP-NO PIN
 * NC-NO CONNECTION WITH PIN

MODEL NUMBER	INPUT VOLTAGE	OUTPUT VOLTAGE	OUTPUT CURRENT		INPUT CURRENT		% EFF.		CAPACITOR LOAD MAX.
			MIN.	MAX.	NO LOAD	FULL LOAD	(2)	(3)	
EC8AW-24S33	9-36 VDC	3.3 VDC	0 mA	4000 mA	8 mA	625 mA	88	88	4000µF
EC8AW-24S05	9-36 VDC	5 VDC	0 mA	3000 mA	8 mA	694 mA	90	90	3000µF
EC8AW-24S12	9-36 VDC	12 VDC	0 mA	1250 mA	8 mA	694 mA	90	90	1250µF
EC8AW-24S15	9-36 VDC	15 VDC	0 mA	1000 mA	8 mA	694 mA	90	90	1000µF
EC8AW-24D12	9-36 VDC	±12 VDC	0 mA	±625 mA	8 mA	702 mA	89	89	625µF
EC8AW-24D15	9-36 VDC	±15 VDC	0 mA	±500 mA	8 mA	694 mA	90	90	500µF
EC8AW-48S33	18-75 VDC	3.3 VDC	0 mA	4000 mA	6 mA	309 mA	89	89	4000µF
EC8AW-48S05	18-75 VDC	5 VDC	0 mA	3000 mA	6 mA	347 mA	90	90	3000µF
EC8AW-48S12	18-75 VDC	12 VDC	0 mA	1250 mA	6 mA	347 mA	90	90	1250µF
EC8AW-48S15	18-75 VDC	15 VDC	0 mA	1000 mA	6 mA	347 mA	90	90	1000µF
EC8AW-48D12	18-75 VDC	±12 VDC	0 mA	±625 mA	6 mA	351 mA	89.5	89.5	625µF
EC8AW-48D15	18-75 VDC	±15 VDC	0 mA	±500 mA	6 mA	347 mA	90	90	500µF

NOTE:

1. Nominal Input Voltage 24 or 48VDC
2. Measure at 12VDC for EC8AW 24 Vin, 24VDC for EC8AW 48 Vin
3. Measure at Nominal Input Voltage

Derating Curve

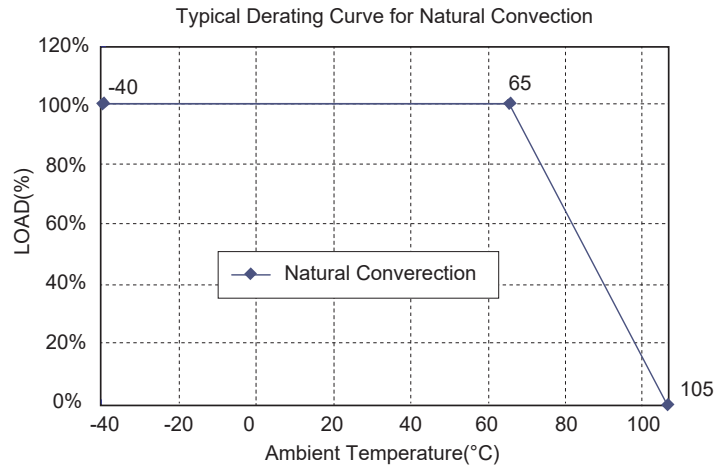

Specification

All Specifications Typical At Nominal Line, Full Load, and 25°C Unless Otherwise Noted

INPUT SPECIFICATIONS

Input Voltage Range	24V 9-36V
	48V 18-75V
Input Surge Voltage (100ms max.)	24V 50Vdc max.
	48V 100Vdc max.
Under Voltage Lockout	24Vin
	power up 8.8V
	power down 8V
	48Vin
	power up 17V
	power down 16V
Input Filter	Pi Type
Remote On/Off Control	
Logic Compatibility	CMOS or Open Collector TTL, Referenced to -Vin
Module On	>3.5VDC to Vin or Open Circuit
Module Off	<1.2VDC

OUTPUT SPECIFICATIONS

Voltage Accuracy	±1.5% max.
Voltage Balance (Dual)	±1.0% max.
Transient Response: 75% - 100% Step Load Change	
Error Band	±5% Vout Nominal
Recovery Time	< 250µs
Ripple & Noise, 20MHz BW (note 3)	
Single	75mV pk-pk max.
Dual	75mV pk-pk max.
Temperature Coefficient	±0.03%/°C
Line Regulation (note 1)	
Single	±0.2% max.
Dual	±0.5% max.
Load Regulation (note 2)	
Single	±0.5% max.
Dual	±1.0% max.
Cross Regulation (Dual Output) Load Cross Variation 10%/100%	±5% max.
Current Limit	110% - 160% Nominal Output
Output Short Circuit Protection	Continuous (Hiccup Mode)
Over Voltage Protection (Zener Diode Clamp)	
	3.3V 3.9Vdc typ.
	5V 6.2Vdc typ.
	12V 15Vdc typ.
	15V 18Vdc typ.
Start up time	15ms typ.

GENERAL SPECIFICATIONS

Efficiency	See Table
Isolation Voltage	Input/Output 1500VDC min.
Isolation Resistance	10 ⁹ ohm min.
Isolation Capacitance	1000pF typ.
Switching Frequency	300KHz typ.
EMI/RFI	Conductive EMI Meet EN55022 Class A
Operating Ambient Temperature	-40°C to +85°C
De-rating, Above 65°C	Linearly to Zero power at 105°C
Case Temperature (note 4)	105°C max.
Cooling	Natural Convection
Storage Temperature	-40°C to +125°C
Humidity	95% RH max. Non condensing
MTBF ... MIL-STD-217F, GB, 25°C, Full Load	XXS33/05 960Khrs typ.
	Others 125Khrs typ.
Dimensions	DIP
	1.25 x 0.80 x 0.40 inches (31.8 x 20.3 x 10.2 mm)
Case Material	Black Coated Copper with Non-Conductive Base
Weight	18 g

NOTE

1. Measured from high line to low line.
2. Measured from full load to min. load.
3. Measured with 0.1µF MLCC.
4. Maximum case temperature under any operating condition should not be exceeded 105°C.

EC2SB SERIES

10 WATT, 2:1 INPUT RANGE

Features

- ◆ 10W Isolated Output
- ◆ Efficiency to 87%
- ◆ 2 : 1 Input Range
- ◆ Regulated Outputs
- ◆ Fixed Switching Frequency
- ◆ Input Under Voltage Protection
- ◆ Over Current Protection
- ◆ Remote On/Off
- ◆ Continuous Short Circuit Protection
- ◆ Conductive EMI Meets EN55022 Class A
- ◆ Without Tantalum Capacitors Inside
- ◆ CE Mark Meets 2014/30/EU
- ◆ Safety Meets UL60950-1, EN60950-1, and IEC60950-1



Mechanical Dimensions

NOTE: Pin Size is 0.04" ±0.004 Inch (1.0±0.1 mm) DIA
 All Dimensions in Inches (mm)
 Tolerance Inches: X.XX±0.02 , X.XXX±0.010
 Millimeters: X.X±0.5 , X.XX±0.25

THROUGH-HOLE PACKAGE

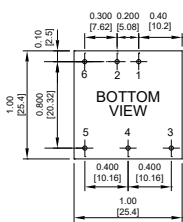

Suffix "+K-C087" Type

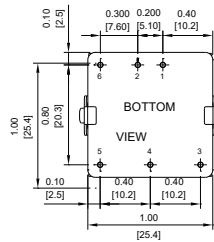

SMD- PACKAGE

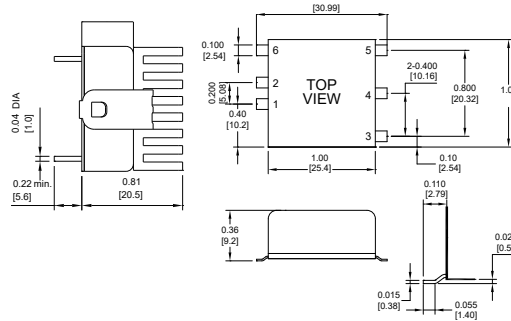

Pin	Function	
	Single	Dual
1	+Input	+Input
2	-Input	-Input
3	+V Output	+V Output
4	Trim	Common
5	-V Output	-V Output
6	Remote	Remote

MODEL NUMBER	INPUT VOLTAGE	OUTPUT VOLTAGE	OUTPUT CURRENT		INPUT CURRENT		% EFF.	CAPACITOR LOAD MAX.
			MIN.	MAX.	NO LOAD	FULL LOAD		
EC2SB-05S33	4.7-9 VDC	3.3 VDC	0 mA	2500 mA	120 mA	1897 mA	87	2470µF
EC2SB-05S05	4.7-9 VDC	5 VDC	0 mA	2000 mA	120 mA	2299 mA	87	2000µF
EC2SB-05S12	4.7-9 VDC	12 VDC	0 mA	833 mA	50 mA	2298 mA	87	940µF
EC2SB-05S15	4.7-9 VDC	15 VDC	0 mA	666 mA	50 mA	2297 mA	87	690µF
EC2SB-05D15	4.7-9 VDC	±5 VDC	0 mA	±1000 mA	50 mA	2353 mA	85	1000µF
EC2SB-05D12	4.7-9 VDC	±12 VDC	0 mA	±416 mA	50 mA	2295 mA	87	440µF
EC2SB-05D15	4.7-9 VDC	±15 VDC	0 mA	±333 mA	50 mA	2297 mA	87	330µF
EC2SB-12S33	9-18 VDC	3.3 VDC	0 mA	2500 mA	30 mA	838 mA	82	2470µF
EC2SB-12S05	9-18 VDC	5 VDC	0 mA	2000 mA	30 mA	980 mA	85	2000µF
EC2SB-12S12	9-18 VDC	12 VDC	0 mA	833 mA	35 mA	957 mA	87	940µF
EC2SB-12S15	9-18 VDC	15 VDC	0 mA	666 mA	35 mA	956 mA	87	690µF
EC2SB-12D05	9-18 VDC	±5 VDC	0 mA	±1000 mA	45 mA	980 mA	85	1000µF
EC2SB-12D12	9-18 VDC	±12 VDC	0 mA	±416 mA	45 mA	957 mA	87	440µF
EC2SB-12D15	9-18 VDC	±15 VDC	0 mA	±333 mA	45 mA	957 mA	87	330µF
EC2SB-24S33	18-36 VDC	3.3 VDC	0 mA	2500 mA	25 mA	419 mA	82	2470µF
EC2SB-24S05	18-36 VDC	5 VDC	0 mA	2000 mA	25 mA	490 mA	85	2000µF
EC2SB-24S12	18-36 VDC	12 VDC	0 mA	833 mA	25 mA	478 mA	87	940µF
EC2SB-24S15	18-36 VDC	15 VDC	0 mA	666 mA	25 mA	478 mA	87	690µF
EC2SB-24D05	18-36 VDC	±5 VDC	0 mA	±1000 mA	25 mA	490 mA	85	1000µF
EC2SB-24D12	18-36 VDC	±12 VDC	0 mA	±416 mA	25 mA	478 mA	87	440µF
EC2SB-24D15	18-36 VDC	±15 VDC	0 mA	±333 mA	25 mA	478 mA	87	330µF
EC2SB-48S33	36-75 VDC	3.3 VDC	0 mA	2500 mA	20 mA	212 mA	81	2470µF
EC2SB-48S05	36-75 VDC	5 VDC	0 mA	2000 mA	20 mA	245 mA	85	2000µF
EC2SB-48S12	36-75 VDC	12 VDC	0 mA	833 mA	20 mA	239 mA	87	940µF
EC2SB-48S15	36-75 VDC	15 VDC	0 mA	666 mA	20 mA	239 mA	87	690µF
EC2SB-48D05	36-75 VDC	±5 VDC	0 mA	±1000 mA	20 mA	245 mA	85	1000µF
EC2SB-48D12	36-75 VDC	±12 VDC	0 mA	±416 mA	20 mA	239 mA	87	440µF
EC2SB-48D15	36-75 VDC	±15 VDC	0 mA	±333 mA	20 mA	239 mA	87	330µF

NOTE: 1. Nominal Input Voltage 5, 12, 24 or 48 VDC

Derating Curve

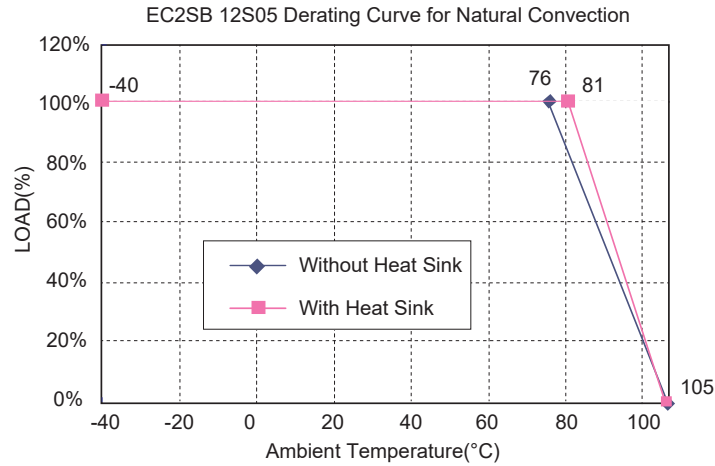

Specification

All Specifications Typical At Nominal Line, Full Load, and 25°C Unless Otherwise Noted

INPUT SPECIFICATIONS

Input Voltage Range	5V 4.7-9V 12V 9-18V 24V 18-36V 48V 36-75V
Under voltage lockout	5Vin power up 4.4V power down 4.2V 12Vin power up 8.8V power down 8V 24Vin power up 17V power down 16V 48Vin power up 34V power down: 32V
Input Surge Voltage (100ms max.)	EC2SB-05Sxx/ 05Dxx 12Vdc max. EC2SB-12Sxx/ 12Dxx 25Vdc max. EC2SB-24Sxx/ 24Dxx 50Vdc max. EC2SB-48Sxx/ 48Dxx 100Vdc max.
Input Filter	Standard PI Type SMD LC Type
Positive Logic Remote On/Off Control:	
Logic Compatibility	CMOS or Open Collector TTL
Module On	>+5.5V to 75VDC or Open Circuit
Module Off	0 to <1.2VDC

OUTPUT SPECIFICATIONS

Voltage Accuracy	±1.5% max.
Voltage Balance (Dual)	±2.0% max.
Transient Response: 25% Step Load Change	< 500µs
Ripple and Noise, 20MHz BW (note 3)	50mV pk-pk max. SMD 100mV pk-pk max.
Temperature Coefficient	±0.03%/°C max.
Short Circuit Protection	Continuous
Line Regulation (note 1)	Single ±0.2% max. SMD ±0.3% max. Dual ±0.5% max.

Load Regulation (note 2)	Single ±0.2% max. SMD ±0.5% max. Dual ±1.0% max.
Cross Regulation (Dual output)	
Load cross variation 10%/100%	±5% max.
Over Voltage Protection	Zener or TVS Clamp
External Trim Adj. Range (single output models only)	±10%
Current Limit	110%~140% Nominal Output
Start up time	20ms max.

GENERAL SPECIFICATIONS

Efficiency	See Table
Isolation Voltage	1500 VDC min.
Isolation Resistance	10 ⁹ ohm min.
Isolation Capacitance	1000pF typ.
Switching Frequency	350KHz typ.
EMI/RFI (Standard)	Conductive EMI Meets EN55022 Class A
Operating Ambient Temperature Range	-40°C to +85°C
Derating, Above 71°C	Linearly to Zero Power at +105°C
Case Temperature (note 4)	105°C max.
Cooling	Natural Convection
Storage Temperature Range	-55°C to +125°C
Humidity	95% RH max. Non condensing
MTBF ... MIL-HDBK-217-F, GB, 25°C, Full Load	1200Khrs typ.
Dimensions	Standard 1.00 x 1.00 x 0.4 inches (25.4 x 25.4 x 10.2 mm) SMD 1.00 x 1.00 x 0.36 inches (25.4 x 25.4 x 9.2 mm)
Case Material	Black Coated Copper with Non-Conductive Base
Weight	18 g

NOTE

1. Measured from high line to low line.
2. Measured from full load to min. load.
3. The output ripple and noise is measured with 10µF tantalum and 1µF ceramic capacitor across output.
4. Maximum case temperature under any operating condition should not be exceeded 105°C.
5. Suffix "S" to the model number with SMD packages.
6. Suffix "+K-C087" type with heat sink.
7. Others Models refer to application note.

EC2SBW SERIES

10 WATT, 4:1 INPUT RANGE

Features

- ◆ 10W Isolated Output
- ◆ 1" x 1" x 0.4" Shielded Metal Case
- ◆ Efficiency to 86%
- ◆ 4 : 1 Input Range
- ◆ Regulated Outputs
- ◆ Input Under Voltage Protection
- ◆ Remote On/Off
- ◆ Continuous Short Circuit Protection
- ◆ Without Tantalum Capacitors Inside
- ◆ CE Mark Meets 2014/30/EU
- ◆ Safety Meets UL60950-1, EN60950-1, and IEC60950-1

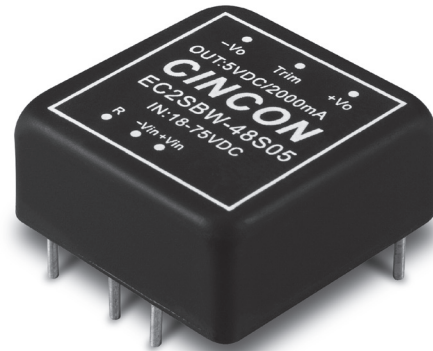

Mechanical Dimensions

NOTE: Pin Size is 0.04" ±0.004 Inch (1.0±0.1 mm) DIA
 All Dimensions in Inches (mm)
 Tolerance Inches: X.XX±0.02, X.XXX±0.010
 Millimeters: X.X±0.5, X.XXX±0.25

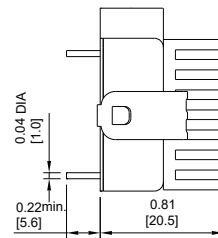
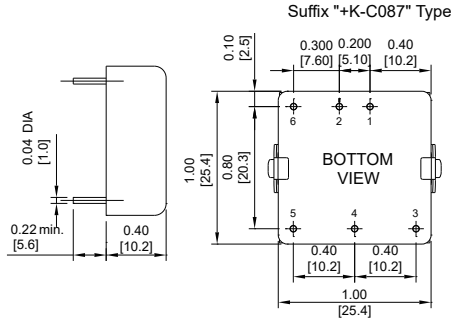
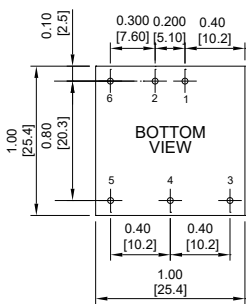

PIN CONNECTION		
PIN	Single Output	Dual Output
1	+Input	+Input
2	-Input	-Input
3	+V Output	+V Output
4	Trim	Common
5	-V Output	-V Output
6	Remote	Remote

MODEL NUMBER	INPUT VOLTAGE	OUTPUT VOLTAGE	OUTPUT CURRENT		INPUT CURRENT		% EFF.	CAPACITOR LOAD MAX.
			MIN.	MAX.	NO LOAD	FULL LOAD		
EC2SBW-24S33	9-36 VDC	3.3 VDC	0 mA	2500 mA	5 mA	425 mA	81	3300µF
EC2SBW-24S05	9-36 VDC	5 VDC	0 mA	2000 mA	5 mA	496 mA	84	2200µF
EC2SBW-24S12	9-36 VDC	12 VDC	0 mA	835 mA	10 mA	486 mA	86	1000µF
EC2SBW-24S15	9-36 VDC	15 VDC	0 mA	666 mA	10 mA	486 mA	86	680µF
EC2SBW-24D05	9-36 VDC	± 5 VDC	0 mA	±1000 mA	10 mA	496 mA	84	1200µF
EC2SBW-24D12	9-36 VDC	± 12 VDC	0 mA	±416 mA	10 mA	486 mA	86	470µF
EC2SBW-24D15	9-36 VDC	± 15 VDC	0 mA	±333 mA	10 mA	486 mA	86	330µF
EC2SBW-48S33	18-75 VDC	3.3 VDC	0 mA	2500 mA	5 mA	210 mA	82	3300µF
EC2SBW-48S05	18-75 VDC	5 VDC	0 mA	2000 mA	5 mA	248 mA	84	2200µF
EC2SBW-48S12	18-75 VDC	12 VDC	0 mA	835 mA	5 mA	243 mA	86	1000µF
EC2SBW-48S15	18-75 VDC	15 VDC	0 mA	666 mA	5 mA	243 mA	86	680µF
EC2SBW-48D05	18-75 VDC	± 5 VDC	0 mA	±1000 mA	5 mA	248 mA	84	1200µF
EC2SBW-48D12	18-75 VDC	± 12 VDC	0 mA	±416 mA	8 mA	243 mA	86	470µF
EC2SBW-48D15	18-75 VDC	± 15 VDC	0 mA	±333 mA	8 mA	243 mA	86	330µF

NOTE: 1. Nominal Input Voltage 24 or 48 VDC

Derating Curve

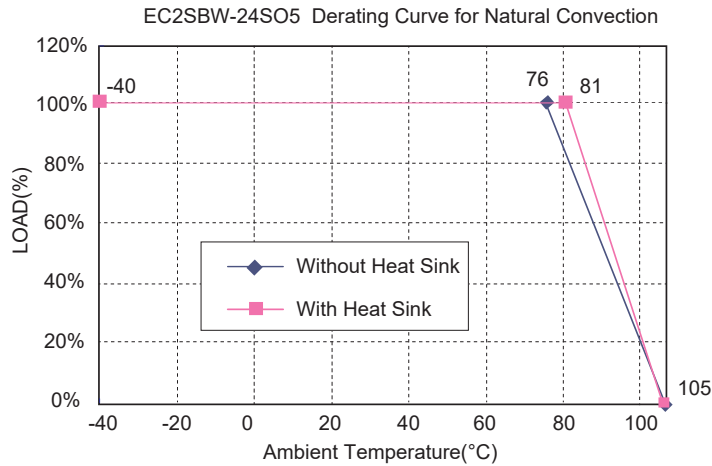

Specification

All Specifications Typical At Nominal Line, Full Load, and 25°C Unless Otherwise Noted

INPUT SPECIFICATIONS

Input Voltage Range	24V	9-36V
	48V	18-75V
Input Surge Voltage (100ms max.)	24V	50Vdc max.
	48V	100Vdc max.
Input Under voltage lockout	24Vin	power up 8.8V typ.
		power down 8.0V typ.
	48Vin	power up 17V typ.
		power down 16V typ.
Input Filter		LC Type
Positive Logic Remote on/off Control (note 3):		
Logic Compatibility		CMOS or Open Collector TTL, Ref. to -Vin
Module On		>+3.5V to 36VDC or Open
Module Off		Circuit 0 to <1.2VDC

OUTPUT SPECIFICATIONS

Voltage Accuracy		±1.5% max.
Voltage Balance (Dual)		±1.0% max.
Transient Response: 75%-100% Step Load Change		
Error Band		5% Vout nominal
Recovery Time		< 500µs
Ripple & Noise, 20MHz BW (note 4)		
Vo=3.3 & 5V		75mV pk-pk max.
Vo=12 & 15V		100mV pk-pk max.
Temperature Coefficient		±0.03%/°C
Short Circuit Protection		Continuous
Line Regulation (note 1)		±0.5% max.
Load Regulation (note 2)	Single	±0.5% max.
	Dual	±1.0% max.
Cross Regulation(Dual output)		
Load cross variation 25%/100%		±5% max
Over Voltage Protection		Zener or TVS Clamp
External Trim Adj. Range (Single Output Models Only)		±10%
Start up time		3.5ms typ.

GENERAL SPECIFICATIONS

Efficiency	See Table
Isolation Voltage	1500 VDC min.
Isolation Resistance	10 ⁹ ohm min.
Isolation Capacitance	1000pF typ.
Switching Frequency	100KHz min.
Operating Ambient Temperature Range	-40°C to +85°C
Derating, Above 71°C (note7)	Linearly to Zero Power at +105°C
Case Temperature (note 5)	105°C max.
Cooling	Natural Convection
Storage Temperature Range	-55°C to +125°C
Humidity	95% RH max. Non condensing
MTBF	MIL-HDBK-217F, GB 1300Khrs typ.
Dimensions	1.00 x 1.00 x 0.4 inches (25.4 x 25.4 x 10.2 mm)
Case Material	Black Coated Copper with Non-Conductive Base
Weight	18 g

NOTE

1. Measured from high line to low line.
2. Measured from full load to min. load.
3. Suffix "N" to the model number with negative logic remote On/Off
Module On 0 to <1.2VDC
Module Off >+3.5VDC to 36VDC or open circuit
4. The output ripple and noise is measured with 10µF tantalum and 1µF ceramic capacitor across output.
5. Maximum case temperature under any operating condition should not be exceeded 105°C.
6. Suffix "+K-C087" type with heat sink.
7. Others models refer to application note.

EC3SB SERIES

15 WATT, 2:1 INPUT RANGE

Features

- ◆ 15W Isolated Output
- ◆ Efficiency to 90%
- ◆ 2 : 1 Input Rang
- ◆ Regulated Outputs
- ◆ Fixed Switching Frequency
- ◆ Input Under Voltage Protection
- ◆ Over Current Protection
- ◆ Remote On/Off
- ◆ Continuous Short Circuit Protection
- ◆ Without Tantalum Capacitors Inside
- ◆ CE Mark Meets 2004/108/EC
- ◆ Safety Meets UL60950-1, EN60950-1, and IEC60950-1

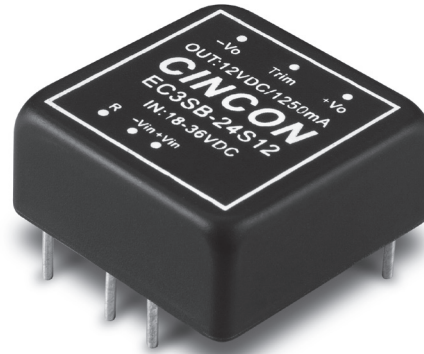

Mechanical Dimensions

NOTE: Pin Size is 0.04" ±0.004 Inch (1.0±0.1 mm) DIA
 All Dimensions in Inches (mm)
 Tolerance Inches: X.XX±0.02, X.XXX±0.010
 Millimeters: X.X±0.5, X.XX±0.25

THROUGH-HOLE PACKAGE

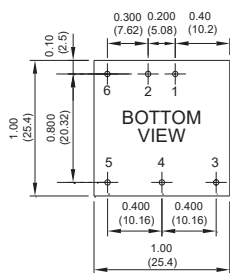

SMD- PACKAGE

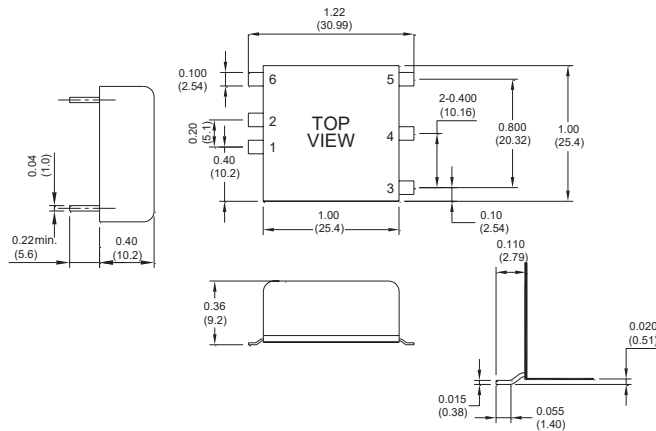

Pin	PIN CONNECTION	
	Single	Dual
1	+Input	+Input
2	-Input	-Input
3	+V Output	+V Output
4	Trim	Common
5	-V Output	-V Output
6	Remote	Remote

MODEL NUMBER	INPUT VOLTAGE	OUTPUT VOLTAGE	OUTPUT CURRENT		INPUT CURRENT		% EFF.	CAPACITOR LOAD MAX.
			MIN.	MAX.	NO LOAD	FULL LOAD		
EC3SB-12S33	9-18 VDC	3.3 VDC	0 mA	4000 mA	90 mA	1280 mA	85	4000µF
EC3SB-12S05	9-18 VDC	5 VDC	0 mA	3000 mA	85 mA	1453 mA	88	3000µF
EC3SB-12S12	9-18 VDC	12 VDC	0 mA	1250 mA	70 mA	1420 mA	88	1330µF
EC3SB-12S15	9-18 VDC	15 VDC	0 mA	1000 mA	70 mA	1420 mA	88	1000µF
EC3SB-12D05	9-18 VDC	±5 VDC	0 mA	±1500 mA	45 mA	1470 mA	85	1470µF
EC3SB-12D12	9-18 VDC	±12 VDC	0 mA	±625 mA	45 mA	1436 mA	87	660µF
EC3SB-12D15	9-18 VDC	±15 VDC	0 mA	±500 mA	45 mA	1420 mA	88	550µF
EC3SB-24S33	18-36 VDC	3.3 VDC	0 mA	4000 mA	50 mA	640 mA	86	4000µF
EC3SB-24S05	18-36 VDC	5 VDC	0 mA	3000 mA	50 mA	718 mA	89	3000µF
EC3SB-24S12	18-36 VDC	12 VDC	0 mA	1250 mA	20 mA	695 mA	90	1330µF
EC3SB-24S15	18-36 VDC	15 VDC	0 mA	1000 mA	20 mA	695 mA	90	1000µF
EC3SB-24D05	18-36 VDC	±5 VDC	0 mA	±1500 mA	25 mA	726 mA	86	1470µF
EC3SB-24D12	18-36 VDC	±12 VDC	0 mA	±625 mA	25 mA	710 mA	88	660µF
EC3SB-24D15	18-36 VDC	±15 VDC	0 mA	±500 mA	25 mA	702 mA	89	550µF
EC3SB-48S33	36-75 VDC	3.3 VDC	0 mA	4000 mA	25 mA	320 mA	86	4000µF
EC3SB-48S05	36-75 VDC	5 VDC	0 mA	3000 mA	30 mA	359 mA	88	3000µF
EC3SB-48S12	36-75 VDC	12 VDC	0 mA	1250 mA	20 mA	347 mA	90	1330µF
EC3SB-48S15	36-75 VDC	15 VDC	0 mA	1000 mA	20 mA	351 mA	90	1000µF
EC3SB-48D05	36-75 VDC	±5 VDC	0 mA	±1500 mA	20 mA	363 mA	86	1470µF
EC3SB-48D12	36-75 VDC	±12 VDC	0 mA	±625 mA	20 mA	355 mA	88	660µF
EC3SB-48D15	36-75 VDC	±15 VDC	0 mA	±500 mA	20 mA	351 mA	89	550µF

NOTE: 1. Nominal Input Voltage 12, 24 or 48 VDC

Derating Curve

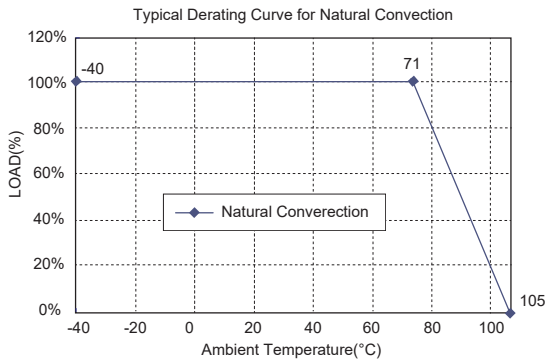

External Output Trim

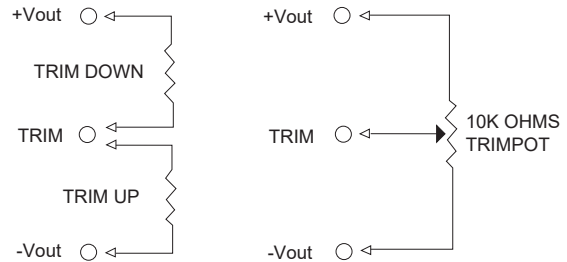

Specification

All Specifications Typical At Nominal Line, Full Load, and 25°C Unless Otherwise Noted

INPUT SPECIFICATIONS

Input Voltage Range	12V 9-18V	24V 18-36V	48V 36-75V
Input Under voltage lockout	12Vin	power up 8.8V	power down 8V
	24Vin	power up 17V	power down 16V
	48Vin	power up 34V	power down 32V
Input Surge Voltage (100ms max.)	EC3SB-12Sxx/12DXX	25Vdc max.	EC3SB-24Sxx/24DXX
	EC3SB-48Sxx/48DXX	50Vdc max.	
Input Filter	Standard:PI Type	100Vdc max.	SMD:LC Type
Positive Logic Remote On/Off Control:			
Logic Compatibility	CMOS or Open Collector TTL		
Module On	>+5.5V to 75VDC or Open Circuit		
Module Off	<1.2VDC		

OUTPUT SPECIFICATIONS

Voltage Accuracy	±1.5% max.
Voltage Balance (Dual)	±2.0% max.
Transient Response: 25% Step Load Change	< 500µs
Ripple and Noise, 20MHz BW (note 3)	50mV pk-pk max.
	120mV pk-pk max.
Temperature Coefficient	±0.03%/°C
Short Circuit Protection	Continuous
Line Regulation (note 1)	DIP±0.2% max., SMD±0.3% max.
	±0.5% max.
Load Regulation (note 2)	DIP±0.2% max., SMD±0.5% max.
	±1.0% max.
Cross Regulation (Dual output)	
Load cross variation 10%/100%	±5% max.
Over Voltage Protection	Zener or TVS Clamp
External Trim Adj. Range	±10%
Current Limit	110%-140% Nominal Output
Start up time	20ms max.

GENERAL SPECIFICATIONS

Efficiency	See Table
Isolation Voltage	1500 VDC min.
Isolation Resistance	10 ⁹ ohm min.
Isolation Capacitance	1000pF typ.
Switching Frequency	350KHz typ.
Operating Ambient Temperature Range	-40°C to +85°C
Derating, Above 71°C	Linearly to Zero Power at +105°C
Case Temperature (note 4)	105°C
Cooling	Natural Convection
Storage Temperature Range	-55°C to +125°C
Humidity	95% RH max. Non condensing
MTBF MIL-STD-217-F, GB, 25°C, Full Load	1200Khrs typ.
Dimensions	DIP
	1.00 x 1.00 x 0.4 inches
	(25.4 x 25.4 x 10.2 mm)
	SMD
	1.00 x 1.00 x 0.36 inches
	(25.4 x 25.4 x 9.2 mm)
Case Material	Black Coated Copper with Non-Conductive Base
Weight	18 g

NOTE

1. Measured from high line to low line.
2. Measured from full load to min. load.
3. The output ripple and noise is measured with 10µF tantalum and 1µF ceramic capacitor across output.
4. Maximum case temperature under any operating condition should not be exceeded 105°C.
5. Suffix "S" to the model number with SMD packages.

EC3SBW SERIES

15 WATT, 4:1 INPUT RANGE

Features

- ◆ 15W Isolated Output
- ◆ 1" x 1" x 0.4" Shielded Metal Case
- ◆ Efficiency to 88%
- ◆ 4 : 1 Input Range
- ◆ Regulated Outputs
- ◆ Fixed Switching Frequency
- ◆ Input Under Voltage Protection
- ◆ Over Current Protection
- ◆ Remote On/Off
- ◆ Continuous Short Circuit Protection
- ◆ Without Tantalum Capacitors inside
- ◆ CE Mark Meets 2014/30/EU
- ◆ Safety Meets UL60950-1, EN60950-1, and IEC60950-1

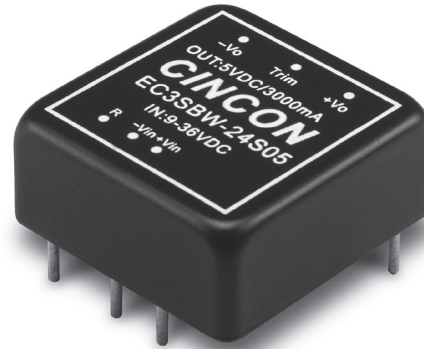

Mechanical Dimensions

NOTE: Pin Size is 0.04" ±0.004 Inch (1.0±0.1 mm) DIA
 All Dimensions in Inches (mm)
 Tolerance Inches: X.XX=±0.02, X.XXX=±0.010
 Millimeters: X.X=±0.5, X.XX=±0.25

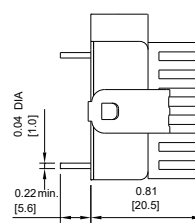
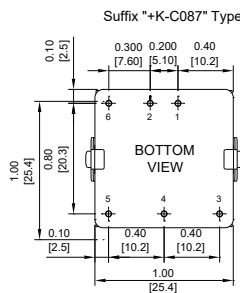
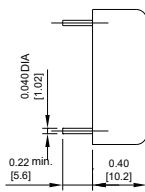
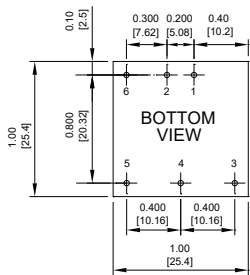

PIN CONNECTION		
PIN	Single Output	Dual Output
1	+Input	+Input
2	-Input	-Input
3	+V Output	+V Output
4	Trim	Common
5	-V Output	-V Output
6	Remote	Remote

MODEL NUMBER	INPUT VOLTAGE	OUTPUT VOLTAGE	OUTPUT CURRENT		INPUT CURRENT		% EFF.	CAPACITOR LOAD MAX.
			MIN.	MAX.	NO LOAD	FULL LOAD		
EC3SBW-24S33	9-36 VDC	3.3 VDC	0 mA	4000 mA	60 mA	632 mA	87	4000µF
EC3SBW-24S05	9-36 VDC	5 VDC	0 mA	3000 mA	70 mA	718 mA	87	3000µF
EC3SBW-24S12	9-36 VDC	12 VDC	0 mA	1250 mA	30 mA	718 mA	87	1250µF
EC3SBW-24S15	9-36 VDC	15 VDC	0 mA	1000 mA	30 mA	710 mA	88	1000µF
EC3SBW-24D05	9-36 VDC	±5 VDC	0 mA	±1500 mA	30 mA	735 mA	85	1500µF
EC3SBW-24D12	9-36 VDC	±12 VDC	0 mA	±625 mA	30 mA	718 mA	87	625µF
EC3SBW-24D15	9-36 VDC	±15 VDC	0 mA	±500 mA	30 mA	710 mA	88	470µF
EC3SBW-48S33	18-75 VDC	3.3 VDC	0 mA	4000 mA	40 mA	313 mA	88	4000µF
EC3SBW-48S05	18-75 VDC	5 VDC	0 mA	3000 mA	40 mA	355 mA	88	3000µF
EC3SBW-48S12	18-75 VDC	12 VDC	0 mA	1250 mA	20 mA	359 mA	87	1250µF
EC3SBW-48S15	18-75 VDC	15 VDC	0 mA	1000 mA	20 mA	359 mA	87	1000µF
EC3SBW-48D05	18-75 VDC	±5 VDC	0 mA	±1500 mA	20 mA	368 mA	85	1500µF
EC3SBW-48D12	18-75 VDC	±12 VDC	0 mA	±625 mA	20 mA	359 mA	87	625µF
EC3SBW-48D15	18-75 VDC	±15 VDC	0 mA	±500 mA	20 mA	359 mA	87	470µF

NOTE: 1. Nominal Input Voltage 24 or 48 VDC

Derating Curve

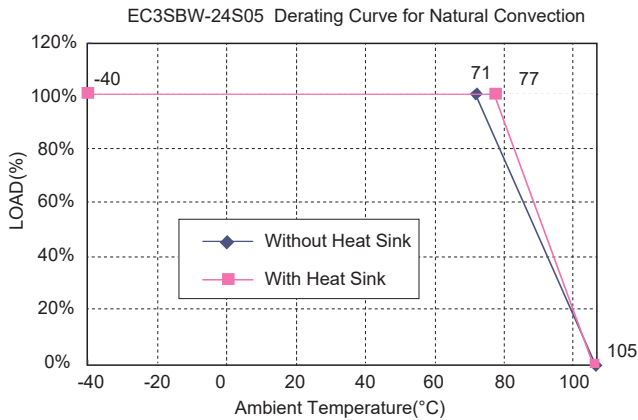

External Output Trim

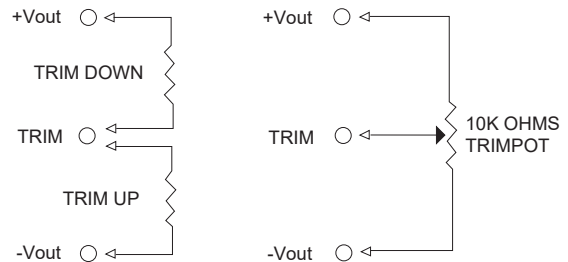

Specification

All Specifications Typical At Nominal Line, Full Load, and 25°C Unless Otherwise Noted

INPUT SPECIFICATIONS

Input Voltage Range	24V	9-36V	
	48V	18-75V	
Input Surge Voltage (100ms max.)	24V	50Vdc max.	
	48V	100Vdc max.	
Under voltage lockout	24Vin	power up	8.8V typ.
		power down	8.0V typ.
	48Vin	power up	17V typ.
		power down	16V typ.
Input Filter		LC Type	
Positive Logic Remote on/off Control:			
Logic Compatibility		CMOS or Open Collector TTL, Ref. to -Vin	
Module On		>+3.5 to 75VDC or Open Circuit	
Module Off		0 to <1.2VDC	

OUTPUT SPECIFICATIONS

Voltage Accuracy		±1.5% max.
Voltage Balance (Dual)		±2.0% max.
Transient Response: 75%-100% Step Load Change.		
Error Band		±5% Vout nominal
Recovery Time		< 250µs
Ripple & Noise, 20MHz BW (note 3)		
Vo=3.3 & 5V		75mV p-p max.
Vo=12 & 15V		100mV p-p max.
Temperature Coefficient		±0.03%/°C
Short Circuit Protection		Continuous
Line Regulation (note 1)	Single	±0.2% max.
	Dual	±0.5% max.
Load Regulation (note 2)	Single	±0.2% max.
	Dual	±1.0% max.
Cross Regulation (Dual output)		
Load cross variation 10%/100%		±5% max.
Over Voltage Protection		Zener or TVS Clamp
External Trim Adj. Range (single output models only)		±10%
Current Limit		110%-170% Nominal Output
Start up time		20ms max.

GENERAL SPECIFICATIONS

Efficiency	See Table	
Isolation Voltage	1500 VDC min.	
Isolation Resistance	10 ⁹ ohm min.	
Isolation Capacitance	1000pF typ.	
Switching Frequency	400KHz typ.	
Operating Ambient Temperature Range	-40°C to +85°C	
Derating, Above 68°C (note6)	Linearly to Zero Power at +105°C	
Case Temperature (note4)	105°C	
Cooling	Natural Convection	
Storage Temperature Range	-55°C to +125°C	
Humidity	95% RH max. Non condensing	
MTBF ..MIL-HDBK-217F, GB, 25°C, Full Load	S33/S05	950Khrs typ.
	Others	1300Khrs typ.
Dimensions	1.00 x 1.00 x 0.40 inches (25.4x25.4x10.2 mm)	
Case Material	Black Coated Copper with Non-Conductive Base	
Weight	18 g	

NOTE

1. Measured from high line to low line.
2. Measured from full load to min. load.
3. The output ripple and noise is measured with 10µF tantalum and 1µF ceramic capacitor across output.
4. Maximum case temperature under any operating condition should not be exceeded 105°C.
5. Suffix "+K-C087" type with heat sink.
6. Others model refer to application note.

EC4SBW SERIES

20 WATT, 4:1 INPUT RANGE

Features

- ◆ 20W Isolated Output
- ◆ 1" x 1" x 0.4" Shielded Metal Case
- ◆ Very High Efficiency Up to 90.5%
- ◆ Low No Load Power Consumption
- ◆ 4 : 1 Input Range
- ◆ Regulated Outputs
- ◆ Fixed Switching Frequency
- ◆ Input Under Voltage Protection
- ◆ Over Current Protection
- ◆ Remote On/Off
- ◆ Continuous Short Circuit Protection
- ◆ Without Tantalum Capacitors Inside
- ◆ CE Mark Meets 2014/30/EU
- ◆ Safety Meets UL60950-1, EN60950-1, and IEC60950-1

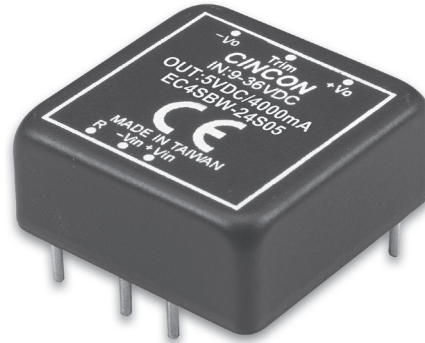

Mechanical Dimensions

All Dimensions in Inches (mm)
 Tolerance Inches: X.XX=±0.04, X.XXX=±0.010
 Millimeters: X.X=±0.5, X.XX=±0.25

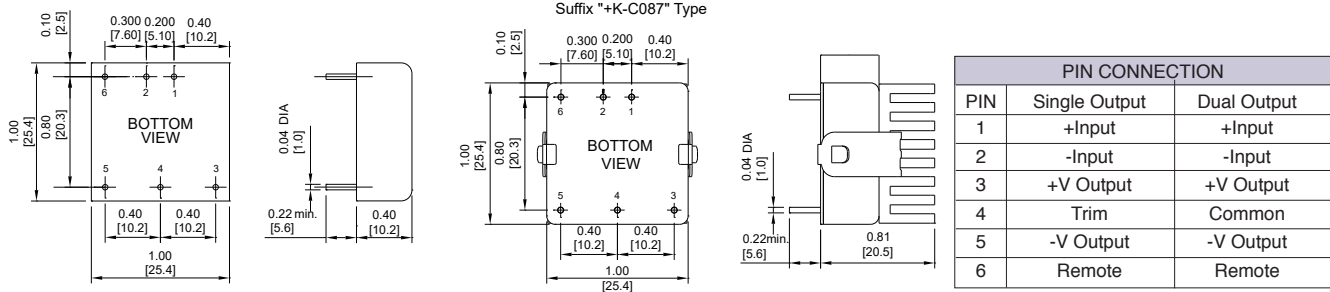

MODEL NUMBER	INPUT VOLTAGE	OUTPUT VOLTAGE	OUTPUT CURRENT		INPUT CURRENT		% EFF.		CAPACITOR LOAD MAX.
			MIN.	MAX.	NO LOAD	FULL LOAD	(2)	(3)	
EC4SBW-24S33	9-36 VDC	3.3 VDC	0 mA	4500 mA	10 mA	699 mA	88	88.5	5000µF
EC4SBW-24S05	9-36 VDC	5 VDC	0 mA	4000 mA	10 mA	920 mA	90	90.5	4000µF
EC4SBW-24S12	9-36 VDC	12 VDC	0 mA	1670 mA	10 mA	938 mA	89	89	1650µF
EC4SBW-24S15	9-36 VDC	15 VDC	0 mA	1330 mA	10 mA	933 mA	89	89	1300µF
EC4SBW-24D12	9-36 VDC	±12 VDC	0 mA	±830 mA	10 mA	938 mA	88.5	88.5	800µF
EC4SBW-24D15	9-36 VDC	±15 VDC	0 mA	±660 mA	10 mA	926 mA	89	89	650µF
EC4SBW-48S33	18-75 VDC	3.3 VDC	0 mA	4500 mA	8 mA	349 mA	89	88.5	5000µF
EC4SBW-48S05	18-75 VDC	5 VDC	0 mA	4000 mA	8 mA	460 mA	90.5	90.5	4000µF
EC4SBW-48S12	18-75 VDC	12 VDC	0 mA	1670 mA	8 mA	466 mA	89.5	89.5	1650µF
EC4SBW-48S15	18-75 VDC	15 VDC	0 mA	1330 mA	8 mA	467 mA	89	89	1300µF
EC4SBW-48D12	18-75 VDC	±12 VDC	0 mA	±830 mA	8 mA	469 mA	89.5	88.5	800µF
EC4SBW-48D15	18-75 VDC	±15 VDC	0 mA	±660 mA	8 mA	466 mA	89.5	88.5	650µF

NOTE:

1. Nominal Input Voltage 24 or 48 VDC
2. Measure at 12VDC for 24 Vin, 24VDC for 48 Vin
3. Measure at Nominal Input Voltage

Derating Curve

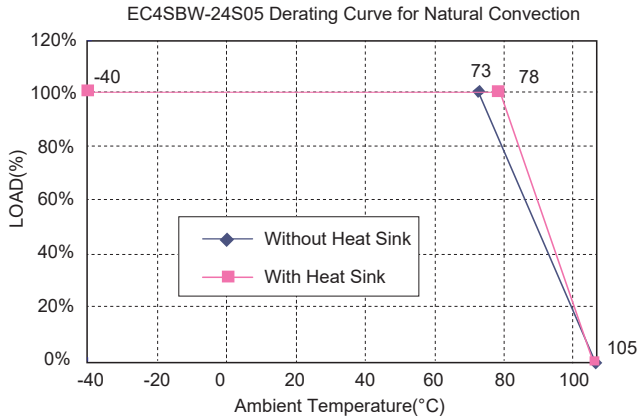

External Output Trim

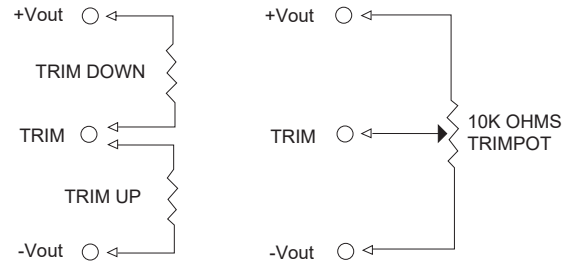

Specification

All Specifications Typical At Nominal Line, Full Load, and 25°C Unless Otherwise Noted

INPUT SPECIFICATIONS

Input Voltage Range	24V 9-36V	48V 18-75V
Input Surge Voltage (100ms max.)	24V 50Vdc max.	48V 100Vdc max.
Under Voltage Lockout	24Vin	power up 8.8V typ. power down 8.0V typ.
	48Vin	power up 17V typ. power down 16V typ.
Input Filter	Pi Type	
Positive Logic Remote On/Off Control (note 4):	CMOS or Open Collector TTL, ref. to -Vin	
Logic Compatibility	Module On >+3.5 to 75VDC or Open Circuit	
	Module Off 0 to <1.2VDC	

OUTPUT SPECIFICATIONS

Voltage Accuracy	±1.5% max.
Voltage Balance (Dual)	±1.5% max.
Transient Response: 75% - 100% Step Load Change.	
Error Band	±5% Vout nominal
Recovery Time	< 250µs
Ripple & Noise, 20MHz BW (note3)	
Vo=3.3 & 5V	75mVpk-pk max.
Vo=12 & 15V	100mVpk-pk max.
Temperature Coefficient	±0.03%/°C
Short Circuit Protection	Continuous
Line Regulation (note 1)	Single ±0.2% max. Dual ±0.5% max.
Load Regulation (note 2)	Single ±0.2% max. Dual ±1.0% max.
Cross Regulation (Dual output)	
Load cross variation 10%/100%	±5% max
Over Voltage Protection	Zener or TVS Clamp
External Trim Adj. Range (single output models only)	±10%
Current Limit	24S33/24S05 110% - 200% Nominal Output Others 110% - 170% Nominal Output
Start up time	20ms max.

GENERAL SPECIFICATIONS

Efficiency	See Table
Isolation Voltage	1500 VDC min.
Isolation Resistance	10 ⁹ ohms min.
Isolation Capacitance	1500pF typ.
Switching Frequency	Vo=3.3 & 5V 270KHz typ. Others 330KHz typ.
Operating Ambient Temperature Range	-40°C to +85°C
Derating, Above 65°C (note7)	Linearly to Zero Power at +105°C
Case Temperature (note 5)	105°C
Cooling	Natural Convection
Storage Temperature Range	-55°C to +125°C
Humidity	95% RH max. Non condensing
MTBF MIL- HDBK -217F, GB, 25°C, Full Load	Others: 1290Khrs typ. Vo: 3.3V/5V: 925Khrs typ.
Dimensions	1.00 x 1.00 x 0.40 inches (25.4 x 25.4 x 10.2 mm)
Case Material	Black Coated Copper with Non-Conductive Base
Weight	18 g

NOTE

1. Measured from high line to low line.
2. Measured from full load to min. load.
3. The output ripple and noise is measured with 10µF tantalum and 1µF ceramic capacitor across output.
4. Suffix "N" to the model number with negative logic remote On/Off
Module On 0 to <1.2VDC
Module Off >3.5VDC to 75VDC or open circuit
5. Maximum case temperature under any operating condition should not be exceeded 105°C.
6. Suffix "+K-C087" type with heat sink.
7. Others Model refer to application note.

EC5SBW SERIES

30 WATT, 4:1 INPUT RANGE

Features

- ◆ 30W Isolated Output
- ◆ 1" x 1" x 0.4" Shielded Metal Case
- ◆ Very High Efficiency Up to 90%
- ◆ Low No Load Power Consumption
- ◆ 4 : 1 Input Range
- ◆ Regulated Outputs
- ◆ Fixed Switching Frequency
- ◆ Input Under Voltage Protection
- ◆ Over Current Protection
- ◆ Remote On/Off
- ◆ Continuous Short Circuit Protection
- ◆ Without Tantalum Capacitors Inside
- ◆ CE Mark Meets 2014/30/EU
- ◆ Safety Meets UL60950-1, EN60950-1, and IEC60950-1



Mechanical Dimensions

NOTE: Pin Size is 0.04" ±0.004 Inch (1.0±0.1 mm) DIA
 Tolerance Inches: X.XX±0.04, X.XXX±0.010
 Millimeters: X.X±0.5, X.XX±0.25

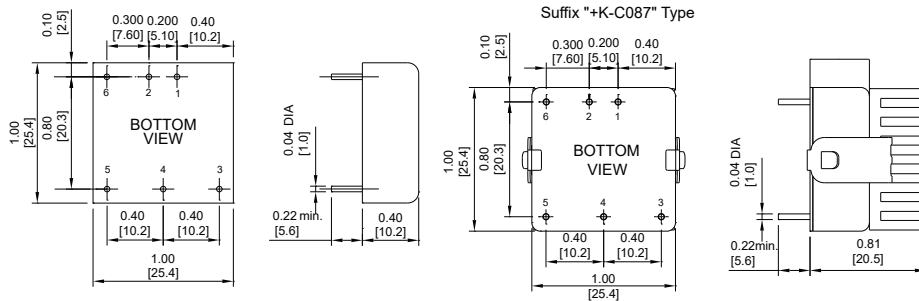

PIN CONNECTION		
PIN	DIP Function	
	Single Output	Dual Output
1	+Input	+Input
2	-Input	-Input
3	+V Output	+V Output
4	Trim	Common
5	-V Output	-V Output
6	Remote	Remote

MODEL NUMBER	INPUT VOLTAGE	OUTPUT VOLTAGE	OUTPUT CURRENT		INPUT CURRENT		% EFF.		CAPACITOR LOAD MAX.
			MIN.	MAX.	NO LOAD	FULL LOAD	(2)	(3)	
EC5SBW-24S33	9-36 VDC	3.3 VDC	0 mA	7500 mA	10 mA	1172 mA	88	88	7500µF
EC5SBW-24S05	9-36 VDC	5 VDC	0 mA	6000 mA	10 mA	1389 mA	89	90	6000µF
EC5SBW-24S12	9-36 VDC	12 VDC	0 mA	2500 mA	10 mA	1404 mA	89	89	2500µF
EC5SBW-24S15	9-36 VDC	15 VDC	0 mA	2000 mA	10 mA	1404 mA	89	89	2000µF
EC5SBW-24D12	9-36 VDC	±12 VDC	0 mA	±1250 mA	10 mA	1404 mA	88	88	1250µF
EC5SBW-24D15	9-36 VDC	±15 VDC	0 mA	±1000 mA	10 mA	1404 mA	88	88	1000µF
EC5SBW-48S33	18-75 VDC	3.3 VDC	0 mA	7500 mA	8 mA	586 mA	88	88	7500µF
EC5SBW-48S05	18-75 VDC	5 VDC	0 mA	6000 mA	8 mA	694 mA	90	90	6000µF
EC5SBW-48S12	18-75 VDC	12 VDC	0 mA	2500 mA	8 mA	694 mA	90	89	2500µF
EC5SBW-48S15	18-75 VDC	15 VDC	0 mA	2000 mA	8 mA	702 mA	90	89	2000µF
EC5SBW-48D12	18-75 VDC	±12 VDC	0 mA	±1250 mA	8 mA	710 mA	89	88	1250µF
EC5SBW-48D15	18-75 VDC	±15 VDC	0 mA	±1000 mA	8 mA	702 mA	89	89	1000µF

NOTE:

1. Nominal Input Voltage 24 or 48 VDC
2. Measure at 12VDC for 24 Vin, 24VDC for 48 Vin
3. Measure at Nominal Input Voltage

Derating Curve

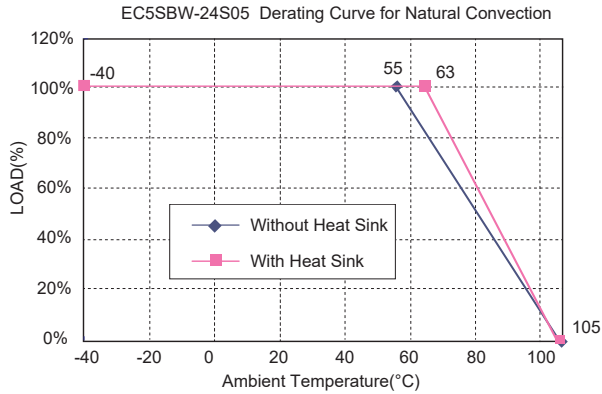

External Output Trim

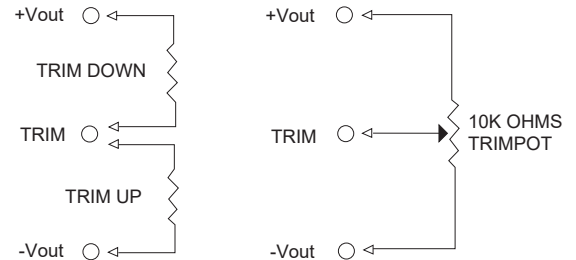

Specification

All Specifications Typical At Nominal Line, Full Load, and 25°C Unless Otherwise Noted

INPUT SPECIFICATIONS

Input Voltage Range	24V	9-36V	
	48V	18-75V	
Input Surge Voltage (100ms max.)	24V	50Vdc max.	
	48V	100Vdc max.	
Under Voltage Lockout	24Vin	power up	8.8V typ.
		power down	8.0V typ.
	48Vin	power up	17V typ.
		power down	16V typ.
Input Filter		Pi Type	
Positive Logic Remote On/Off Control (note 4):			
Logic Compatibility		CMOS or Open Collector TTL, ref. to -Vin	
Module On		>+3.5 to 75VDC or Open Circuit	
Module Off		0 to <1.2VDC	

OUTPUT SPECIFICATIONS

Voltage Accuracy		±1.5% max.
Voltage Balance (Dual)		±1.5% max.
Transient Response: 75% - 100% Step Load Change.		
Error Band		±5% Vout nominal
Recovery Time		< 250µs
Ripple & Noise, 20MHz BW (note 3)		
Vo=3.3 & 5V		75mVpk-pk max.
Vo=12 & 15V		100mVpk-pk max.
Temperature Coefficient		±0.03%/°C
Short Circuit Protection		Continuous
Line Regulation (note 1)	Single	±0.2% max.
	Dual	±0.5% max.
Load Regulation (note 2)	Single	±0.2% max.
	Dual	±1.0% max.
Over Voltage Protection		Zener or TVS Clamp
External Trim Adj. Range (single output models only)		±10%
Current Limit		110% - 170% Nominal Output
Start up time		20ms max.

GENERAL SPECIFICATIONS

Efficiency	See Table
Isolation Voltage	1500 VDC min.
Isolation Resistance	10 ⁹ ohms min.
Isolation Capacitance	1500pF typ.
Switching Frequency	Vo=3.3 & 5V 270KHz typ.
	Others 330KHz typ.
Operating Ambient Temperature Range	-40°C to +85°C
Derating, Above 55°C (note 7)	Linearly to Zero Power at +105°C
Case Temperature (note 5)	105°C
Cooling	Natural Convection
Storage Temperature Range	-55°C to +125°C
Thermal Shutdown Case Temp	110°C typ.
Humidity	95% RH max. Non condensing
MTBF MIL-HDBK-217F, GB, 25°C, Full Load	Others: 860Khrs typ.
	Vo: 3.3V/5V : 1170Khrs typ.
Dimensions	1.00 x 1.00 x 0.40 inches (25.4 x 25.4 x 10.2 mm)
Case Material	Black Coated Copper with Non-Conductive Base
Weight	18 g

NOTE

1. Measured from high line to low line.
2. Measured from full load to min. load.
3. The output ripple and noise is measured with 10µF tantalum and 1µF ceramic capacitor across output.
4. Suffix "N" to the model number with negative logic remote On/Off
Module On 0 to <1.2VDC
Module Off >3.5VDC to 75VDC or open circuit
5. Maximum case temperature under any operating condition should not be exceeded 105°C.
6. Suffix "+K-C087" type with heat sink.
7. Others models refer to application note.

EC3B SERIES

7.5 WATT, 2:1 INPUT RANGE

Features

- ◆ 7.5W Isolated Output
- ◆ Efficiency to 82%
- ◆ 2" x 1" Case
- ◆ Regulated Outputs
- ◆ Pi Input Filter
- ◆ Continuous Short Circuit Protection

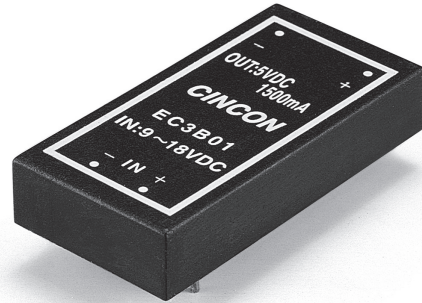

Not Recommended For New Designs

Mechanical Dimensions

All Dimensions in Inches (mm)
 Tolerance Inches: X.XX=±0.04, X.XXX=±0.010
 Millimeters: X.X=±0.5, X.XX=±0.25

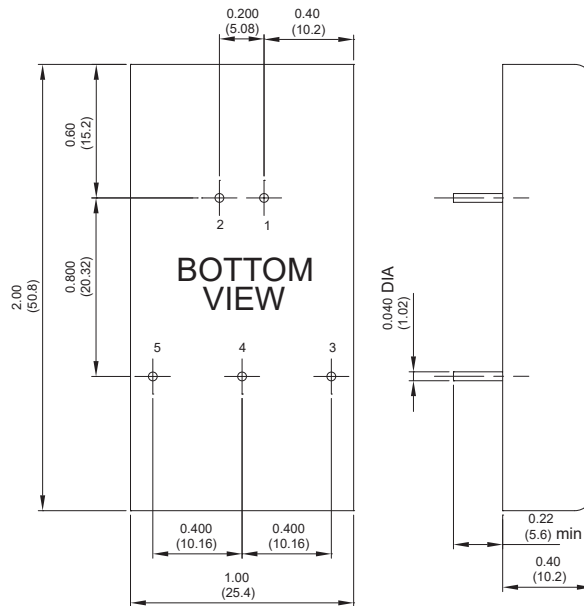

PIN CONNECTION	
Pin	Function
1	+Input
2	-Input
3	+Output
4	Common/NP
5	-Output

* NP-NO PIN ON SINGLE OUTPUT

MODEL NUMBER	INPUT VOLTAGE	OUTPUT VOLTAGE	OUTPUT CURRENT	INPUT CURRENT		% EFF.	SIZE
				NO LOAD	FULL LOAD		
EC3B01	9-18 VDC	5 VDC	1500 mA	7.5 mA	820 mA	76	2"x1"
EC3B02	9-18 VDC	12 VDC	625 mA	7.5 mA	780 mA	80	2"x1"
EC3B03	9-18 VDC	15 VDC	500 mA	7.5 mA	780 mA	80	2"x1"
EC3B04	9-18 VDC	±12 VDC	±310 mA	12 mA	775 mA	80	2"x1"
EC3B05	9-18 VDC	±15 VDC	±250 mA	12 mA	780 mA	80	2"x1"
EC3B06	9-18 VDC	±5 VDC	±750 mA	7.5 mA	820 mA	76	2"x1"
EC3B07	9-18 VDC	3.3 VDC	1500 mA	7.5 mA	557 mA	74	2"x1"
EC3B11	18-36 VDC	5 VDC	1500 mA	5 mA	400 mA	78	2"x1"
EC3B12	18-36 VDC	12 VDC	625 mA	5 mA	380 mA	82	2"x1"
EC3B13	18-36 VDC	15 VDC	500 mA	5 mA	380 mA	82	2"x1"
EC3B14	18-36 VDC	±12 VDC	±310 mA	7.5 mA	385 mA	81	2"x1"
EC3B15	18-36 VDC	±15 VDC	±250 mA	7.5 mA	385 mA	81	2"x1"
EC3B16	18-36 VDC	±5 VDC	±750 mA	7.5 mA	400 mA	78	2"x1"
EC3B17	18-36 VDC	3.3 VDC	1500 mA	5 mA	271 mA	76	2"x1"
EC3B21	36-72 VDC	5 VDC	1500 mA	2 mA	200 mA	78	2"x1"
EC3B22	36-72 VDC	12 VDC	625 mA	2 mA	192 mA	81	2"x1"
EC3B23	36-72 VDC	15 VDC	500 mA	2 mA	192 mA	81	2"x1"
EC3B24	36-72 VDC	±12 VDC	±310 mA	3 mA	192 mA	81	2"x1"
EC3B25	36-72 VDC	±15 VDC	±250 mA	3 mA	192 mA	81	2"x1"
EC3B26	36-72 VDC	±5 VDC	±750 mA	3 mA	200 mA	78	2"x1"
EC3B27	36-72 VDC	3.3 VDC	1500 mA	3 mA	136 mA	76	2"x1"

NOTE: 1. Nominal Input Voltage 12, 24 or 48VDC

Derating Curve

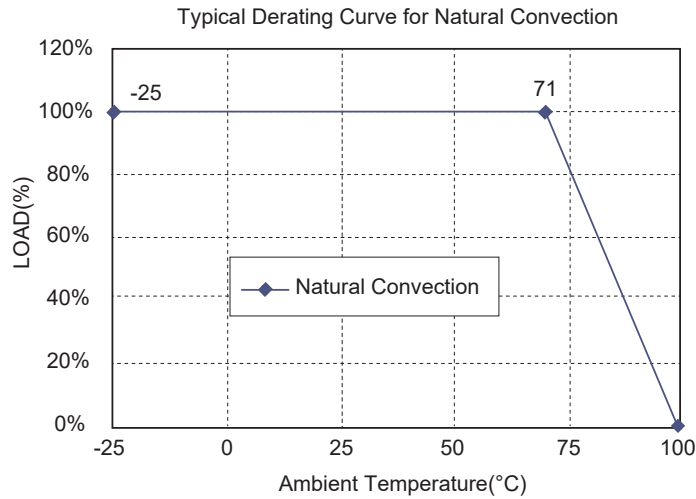

Specification

All Specifications Typical At Nominal Line, Full Load, and 25°C Unless Otherwise Noted

INPUT SPECIFICATIONS

Input Voltage Range	12V..... 9-18V
	24V 18-36V
	48V 36-72V
Input Filter	Pi Type

OUTPUT SPECIFICATIONS

Voltage Accuracy	±2.0% max.
Voltage Balance (Dual)	±1.0% max.
Temperature Coefficient	±0.05%/°C
Ripple & Noise, 20MHz BW	3.3V/5V.....100mV p-p max.
	12V/15V.....1%p-p max.
Short Circuit Protection	Continuous
Line Regulation Single/Dual (note 1)	±0.5% max.
Load Regulation Single (note 2)	±0.5% max.
Dual (note 3)	±1.0% max.

GENERAL SPECIFICATIONS

Efficiency	See Table
Isolation Voltage	1500 VDC min.
Isolation Resistance	10 ⁹ ohms
Switching Frequency	100KHz min.
Operating Ambient Temperature Range	-25°C to +71°C
De-rating, Above 71°C	Linearly to Zero power at 100°C
Case Temperature (note 4)	100°C max.
Cooling	Natural Convection
Storage Temperature Range	-40°C to +100°C
Dimensions	2.00 × 1.00 × 0.40 inches (50.8 × 25.4 × 10.2mm)
Case Material	Black Coated Copper With Non-Conductive Base
Weight	35 g

NOTE

1. Measured from high line to low line.
2. Measured from full load to 10% load.
3. Measured from full load to 1/4 load.
4. Maximum case temperature under any operating condition should not be exceeded 100°C.

EC3BB SERIES

7.5 WATT, 2:1 INPUT RANGE

Features

- ◆ 7.5W Isolated Output
- ◆ Remote On/Off (Option)
- ◆ Efficiency to 82%
- ◆ 2" x 1" Case
- ◆ Regulated Outputs
- ◆ Continuous Short Circuit Protection
- ◆ Meets EN55022 Class B, Conducted
- ◆ Pi Input Filter

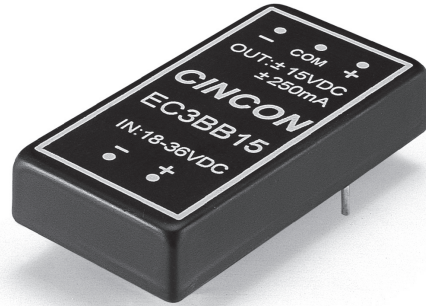

Mechanical Dimensions

All Dimensions in Inches (mm)
 Tolerance Inches: X.XX=±0.04, X.XXX=±0.010
 Millimeters: X.X=±0.5, X.XX=±0.25

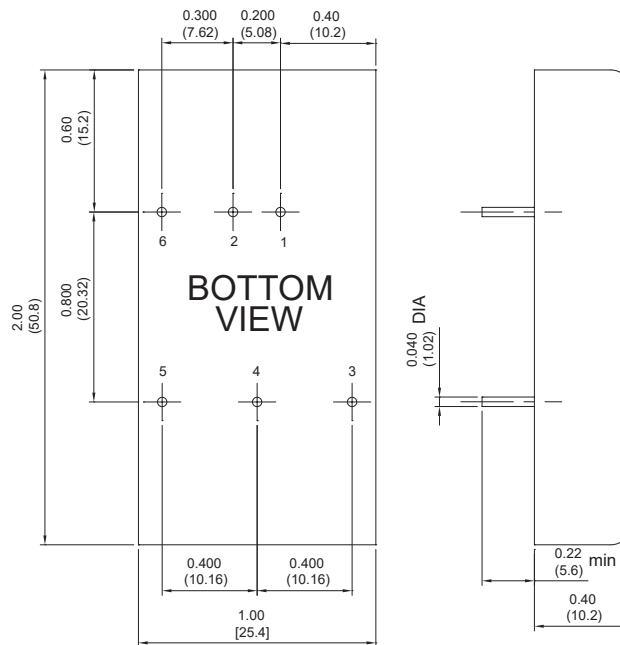

PIN CONNECTION	
Pin	Function
1	+Input
2	-Input
3	+Output
4	Common/NP
5	-Output
6	NP(Remote On/Off)

* NP-NO PIN ON SINGLE OUTPUT

MODEL NUMBER	INPUT VOLTAGE	OUTPUT VOLTAGE	OUTPUT CURRENT	INPUT CURRENT		% EFF.	SIZE
				NO LOAD	FULL LOAD		
EC3BB01	9-18 VDC	5 VDC	1500 mA	7.5 mA	820 mA	76	2"x1"
EC3BB02	9-18 VDC	12 VDC	625 mA	7.5 mA	780 mA	80	2"x1"
EC3BB03	9-18 VDC	15 VDC	500 mA	7.5 mA	780 mA	80	2"x1"
EC3BB04	9-18 VDC	±12 VDC	±310 mA	12 mA	775 mA	80	2"x1"
EC3BB05	9-18 VDC	±15 VDC	±250 mA	12 mA	780 mA	80	2"x1"
EC3BB06	9-18 VDC	±5 VDC	±750 mA	7.5 mA	820 mA	76	2"x1"
EC3BB07	9-18 VDC	3.3 VDC	1500 mA	7.5 mA	557 mA	74	2"x1"
EC3BB11	18-36 VDC	5 VDC	1500 mA	5 mA	400 mA	78	2"x1"
EC3BB12	18-36 VDC	12 VDC	625 mA	5 mA	380 mA	82	2"x1"
EC3BB13	18-36 VDC	15 VDC	500 mA	5 mA	380 mA	82	2"x1"
EC3BB14	18-36 VDC	±12 VDC	±310 mA	7.5 mA	385 mA	81	2"x1"
EC3BB15	18-36 VDC	±15 VDC	±250 mA	7.5 mA	385 mA	81	2"x1"
EC3BB16	18-36 VDC	±5 VDC	±750 mA	7.5 mA	400 mA	78	2"x1"
EC3BB17	18-36 VDC	3.3 VDC	1500 mA	5 mA	271 mA	76	2"x1"
EC3BB21	36-72 VDC	5 VDC	1500 mA	2 mA	200 mA	78	2"x1"
EC3BB22	36-72 VDC	12 VDC	625 mA	2 mA	192 mA	81	2"x1"
EC3BB23	36-72 VDC	15 VDC	500 mA	2 mA	192 mA	81	2"x1"
EC3BB24	36-72 VDC	±12 VDC	±310 mA	3 mA	192 mA	81	2"x1"
EC3BB25	36-72 VDC	±15 VDC	±250 mA	3 mA	192 mA	81	2"x1"
EC3BB26	36-72 VDC	±5 VDC	±750 mA	3 mA	200 mA	78	2"x1"
EC3BB27	36-72 VDC	3.3 VDC	1500 mA	3 mA	136 mA	76	2"x1"

NOTE: 1. Nominal Input Voltage 12, 24 or 48 VDC

Derating Curve

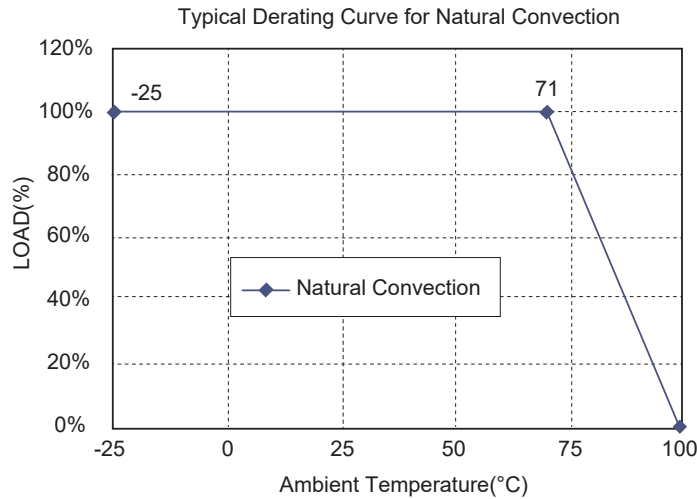

Specification

All Specifications Typical At Nominal Line, Full Load, and 25°C Unless Otherwise Noted

INPUT SPECIFICATIONS

Input Voltage Range	12V..... 9-18V
	24V 18-36V
	48V 36-72V
Input Filter	Pi Type

OUTPUT SPECIFICATIONS

Voltage Accuracy	±2.0% max.
Voltage Balance (Dual)	±1.0% max.
Temperature Coefficient	±0.05%/°C
Ripple & Noise, 20MHz BW	3.3V/5V.....100mV p-p max.
	12V/15V..... 1%p-p max.
Short Circuit Protection	Continuous
Line Regulation Single/Dual (note 1)	±0.5% max.
Load Regulation Single (note 2)	±0.5% max.
Dual (note 3)	±1.0% max.

GENERAL SPECIFICATIONS

Efficiency	See Table
Isolation Voltage	1500 VDC min.
Isolation Resistance	10 ⁹ ohms
Switching Frequency	100KHz min.
Operating Ambient Temperature Range	-25°C to +71°C
De-rating, Above 71°C	Linearly to Zero power at 100°C
Case Temperature (note 5)	100°C max.
Cooling	Natural Convection
Storage Temperature Range	-40°C to +100°C
EMI/RFI	Conductive EMI Meet EN55022 Class B
Dimensions	2.00 × 1.00 × 0.40 inches (50.8 × 25.4 × 10.2mm)
Case Material	Black Coated Copper With Non-Conductive Base
Weight	32.5 g

NOTE

1. Measured from high line to low line.
2. Measured from full load to 10% load.
3. Measured from full load to 1/4 load.
4. Suffix "T" to the model number with remote On/Off

Module On	>5.5VDC or open circuit
Module Off	<1.8VDC
Shutdown idle	10mA
Control common	referenced to input minus
5. Maximum case temperature under any operating condition should not be exceeded 100°C.

EC4BE SERIES

10 WATT, 2:1 INPUT RANGE

Features

- ◆ 10W Isolated Output
- ◆ 2" x 1" Six-Sided Shield Metal Case
- ◆ Efficiency to 82%
- ◆ 2 : 1 Input Range
- ◆ Pi Input Filter
- ◆ Continuous Short Circuit Protection
- ◆ Meets EN55022 Class A, Conducted
- ◆ UL60950-1 Approval

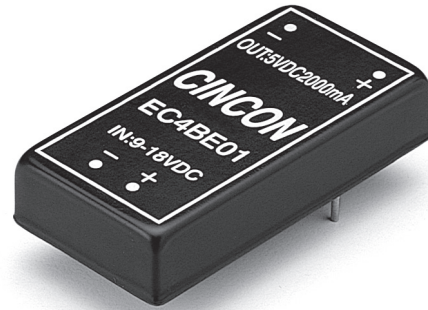

Mechanical Dimensions

NOTE: Pin Size is 0.04±0.004 Inch (1.0±0.1 mm) DIA

All Dimensions in Inches (mm)

Tolerance Inches: X.XX=±0.04 , X.XXX=±0.010
 Millimeters: X.X=±0.5 , X.XX=±0.25

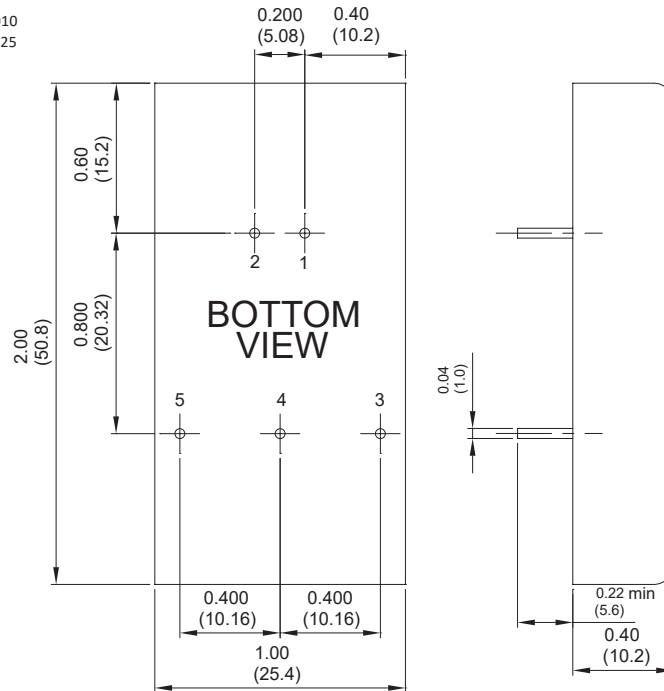

PIN CONNECTION	
Pin	Function
1	+Input
2	-Input
3	+Output
4	Common/NP
5	-Output

* NP-NO PIN ON SINGLE OUTPUT

MODEL NUMBER	INPUT VOLTAGE	OUTPUT VOLTAGE	OUTPUT CURRENT		INPUT CURRENT		% EFF.	CAPACITOR LOAD MAX.
			MIN.	MAX.	NO LOAD	FULL LOAD		
EC4BE01	9-18 VDC	5 VDC	100 mA	2000 mA	30 mA	1100 mA	76	2000µF
EC4BE02	9-18 VDC	12 VDC	45 mA	830 mA	30 mA	1065 mA	78	830µF
EC4BE03	9-18 VDC	15 VDC	35 mA	666 mA	30 mA	1065 mA	78	666µF
EC4BE04	9-18 VDC	±12 VDC	±25 mA	±415 mA	40 mA	1065 mA	78	415µF
EC4BE05	9-18 VDC	±15 VDC	±20 mA	±333 mA	40 mA	1065 mA	78	333µF
EC4BE06	9-18 VDC	±5 VDC	±50 mA	±1000 mA	40 mA	1065 mA	78	1000µF
EC4BE11	18-36 VDC	5 VDC	100 mA	2000 mA	20 mA	535 mA	78	2000µF
EC4BE12	18-36 VDC	12 VDC	45 mA	830 mA	20 mA	520 mA	80	830µF
EC4BE13	18-36 VDC	15 VDC	35 mA	666 mA	20 mA	520 mA	80	666µF
EC4BE14	18-36 VDC	±12 VDC	±25 mA	±415 mA	20 mA	520 mA	80	415µF
EC4BE15	18-36 VDC	±15 VDC	±20 mA	±333 mA	20 mA	520 mA	80	333µF
EC4BE16	18-36 VDC	±5 VDC	±50 mA	±1000 mA	20 mA	520 mA	80	1000µF
EC4BE21	36-72 VDC	5 VDC	100 mA	2000 mA	10 mA	260 mA	80	2000µF
EC4BE22	36-72 VDC	12 VDC	45 mA	830 mA	10 mA	254 mA	82	830µF
EC4BE23	36-72 VDC	15 VDC	35 mA	666 mA	10 mA	254 mA	82	666µF
EC4BE24	36-72 VDC	±12 VDC	±25 mA	±415 mA	10 mA	254 mA	82	415µF
EC4BE25	36-72 VDC	±15 VDC	±20 mA	±333 mA	10 mA	254 mA	82	333µF
EC4BE26	36-72 VDC	±5 VDC	±50 mA	±1000 mA	10 mA	254 mA	82	1000µF

NOTE: 1. Nominal Input Voltage 12, 24 or 48VDC

Derating Curve

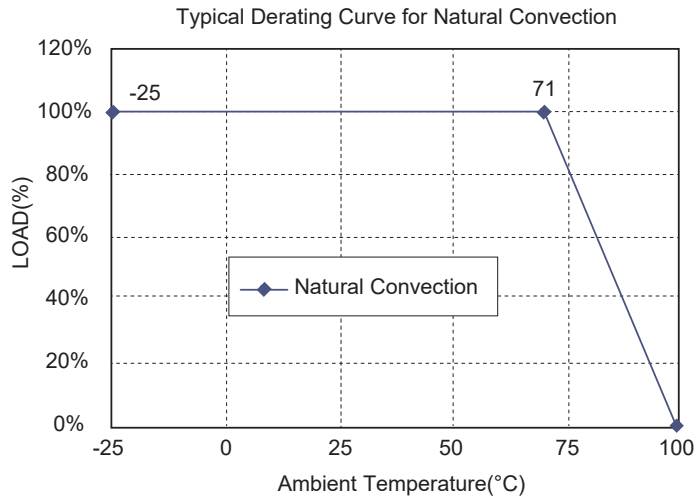

Specification

All Specifications Typical At Nominal Line, Full Load, and 25°C Unless Otherwise Noted

INPUT SPECIFICATIONS

Input Voltage Range	12V9-18V 24V 18-36V 48V 36-72V
Input Surge Voltage (100ms max.)	12V 25Vdc max. 24V 50Vdc max. 48V 100Vdc max.
Input Filter	Pi Type

OUTPUT SPECIFICATIONS

Voltage Accuracy	±1.0% max.
Voltage Balance (Dual)	±1.0% max.
Transient Response	
Single 25% Step Load Change	< 500µs
Dual FL-1/2L±1% Error Band	< 500µs
Ripple and Noise, 20MHz BW	100mV pk-pk max.
Temperature Coefficient	±0.02%/°C
Short Circuit Protection	Continuous
Line Regulation (note 1)	±0.2% max.
Load Regulation (note 2)	±1.0% max.
Start up time	12Vin, 24Vin 60ms typ. 48Vin 28ms typ.

GENERAL SPECIFICATIONS

Efficiency	See Table
Isolation Voltage	500 VDC min
Isolation Resistance	10 ⁹ ohm min.
Isolation Capacitance	2500pF typ.
Switching Frequency	200KHz min.
Operating Ambient Temperature Range	-25°C to +71°C
De-rating, Above 71°C	Linearly to Zero power at 100°C
Case Temperature (note 4)	100°C max.
Cooling	Natural Convection
Storage Temperature Range	-40°C to +100°C
Humidity	95% RH max. Non condensing
MTBF MIL-STD-217F, GB, 25°C, Full Load	1400Khrs typ.
EMI/RFI	Six sided Continuous Shield
Dimensions	2.00 x 1.00 x 0.40 inches (50.8 x 25.4 x 10.2 mm)
Case Material	Black Coated Copper with Non-Conductive Base
Weight	33 g

NOTE

1. Measured from high line to low line.
2. Measured from full load to 1/4 load.
3. A minimum load on the output is necessary to maintain regulation.
4. Maximum case temperature under any operating condition should not be exceeded 100°C.

EC4BW SERIES

10 WATT, 4:1 INPUT RANGE

Features

- ◆ 10W Isolated Output
- ◆ 2" x 1" Six-Sided Shield Metal Case
- ◆ Efficiency to 82%
- ◆ 4 : 1 Input Range
- ◆ Pi Input Filter
- ◆ Continuous Short Circuit Protection
- ◆ Meets EN55022 Class A, Conducted



Mechanical Dimensions

NOTE: Pin Size is 0.04±0.004 Inch (1.0±0.1 mm) DIA
 All Dimensions in Inches (mm)
 Tolerance Inches: X.XX±0.04 , X.XXX±0.010
 Millimeters: X.X±0.5 , X.XX±0.25

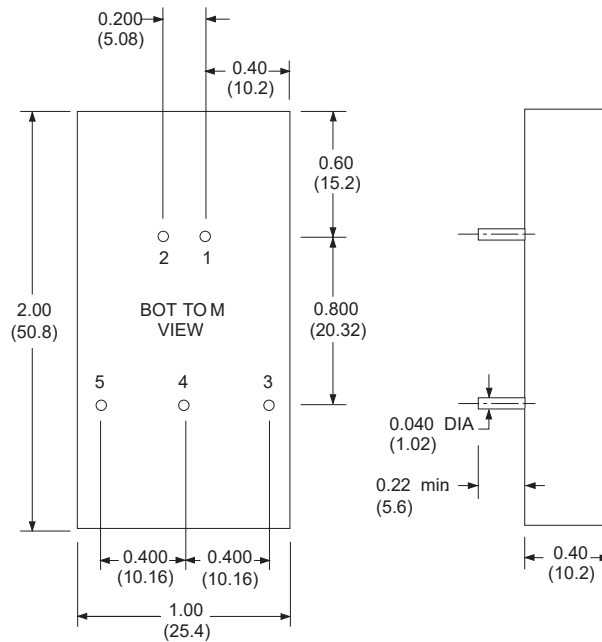

PIN CONNECTION	
Pin	Function
1	+Input
2	-Input
3	+Output
4	Common/NP
5	-Output

* NP-NO PIN ON SINGLE OUTPUT

MODEL NUMBER	INPUT VOLTAGE	OUTPUT VOLTAGE	OUTPUT CURRENT	INPUT CURRENT		% EFF.
				NO LOAD	FULL LOAD	
EC4BW01	9-36 VDC	5 VDC	2000 mA	15 mA	534 mA	78
EC4BW02	9-36 VDC	12 VDC	830 mA	15 mA	520 mA	80
EC4BW03	9-36 VDC	15 VDC	666 mA	15 mA	520 mA	80
EC4BW04	9-36 VDC	±12 VDC	±415 mA	20 mA	520 mA	80
EC4BW05	9-36 VDC	±15 VDC	±333 mA	20 mA	520 mA	80
EC4BW06	9-36 VDC	±5 VDC	±1000 mA	20 mA	520 mA	80
EC4BW07	9-36 VDC	3.3 VDC	2000 mA	15 mA	362 mA	76
EC4BW11	18-72 VDC	5 VDC	2000 mA	10 mA	260 mA	80
EC4BW12	18-72 VDC	12 VDC	830 mA	10 mA	257 mA	81
EC4BW13	18-72 VDC	15 VDC	666 mA	10 mA	257 mA	81
EC4BW14	18-72 VDC	±12 VDC	±415 mA	15 mA	257 mA	81
EC4BW15	18-72 VDC	±15 VDC	±333 mA	15 mA	253 mA	82
EC4BW16	18-72 VDC	±5 VDC	±1000 mA	15 mA	253 mA	82
EC4BW17	18-72 VDC	3.3 VDC	2000 mA	10 mA	181 mA	76

NOTE: 1. Nominal Input Voltage 24 or 48VDC

Derating Curve

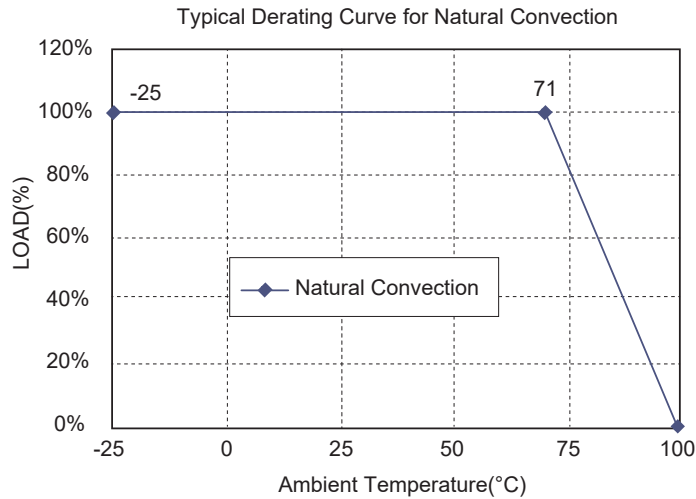

Specification

All Specifications Typical At Nominal Line, Full Load, and 25°C Unless Otherwise Noted

INPUT SPECIFICATIONS

Input Voltage Range	24V 9-36V
	48V 18-72V
Input Surge Voltage (100ms max.)	24V 50Vdc max.
	48V 100Vdc max.
Input Filter	Pi Type

OUTPUT SPECIFICATIONS

Voltage Accuracy	±1.0% max.
Voltage Balance Dual Output at Full Load	±1.0% max.
Transient Response	
Single 25% Step Load Change	< 500µs
Dual FL-1/2L±1% Error Band	< 500µs
Ripple and Noise, 20MHz BW	75mV pk-pk max.
Temperature Coefficient	±0.02%/°C max.
Short Circuit Protection	Continuous
Line Regulation (note 1)	±0.2% max.
Load Regulation (note 2)	±1.0% max.
Start up time	24Vin 5ms typ.
	48Vin 10ms typ.

GENERAL SPECIFICATIONS

Efficiency	See Table
Isolation Voltage	500 VDC
Isolation Resistance	10 ⁹ ohm min.
Isolation Capacitance	500pF typ.
Switching Frequency	300KHz typ.
Operating Ambient Temperature Range	-25°C to +71°C
De-rating, Above 71°C	Linearly to Zero power at 100°C
Case Temperature (note 3)	100°C max.
Cooling	Natural Convection
Storage Temperature Range	-40°C to +100°C
Humidity	95% RH max. Non condensing
MTBF.....MIL-STD-217F, GB, 25°C, Full Load	750K hrs Typ.
EMI/RFI	Six sided Continuous Shield
Dimensions	2.00 x 1.00 x 0.40 inches (50.8 x 25.4 x 10.2 mm)
Case Material	Black Coated Copper with Non-Conductive Base
Weight	32 g

NOTE

1. Measured from high line to low line.
2. Measured from full load to 1/4 load.
3. Maximum case temperature under any operating condition should not be exceeded 100°C.

EC4BU SERIES

10 WATT, 2:1 INPUT RANGE

Features

- ◆ 10W Isolated Output
- ◆ Efficiency to 87%
- ◆ 2 : 1 Input Range
- ◆ Regulated Outputs
- ◆ Fixed Switching Frequency
- ◆ Input Under Voltage Protection
- ◆ Over Current Protection
- ◆ Conductive EMI Meets EN55022 Class A
- ◆ Continuous Short Circuit Protection
- ◆ Without Tantalum Capacitors Inside
- ◆ CE Mark Meets 2004/108/EC
- ◆ Safety Meets UL60950-1, EN60950-1 and IEC60950-1

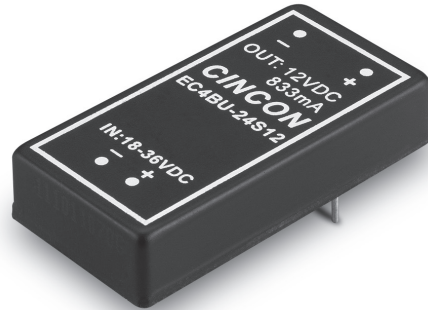

Mechanical Dimensions

NOTE: Pin Size is 0.04±0.004 Inch (1.0±0.1 mm)DIA
 All Dimensions in Inches (mm)
 Tolerance Inches: X.XX±0.04 , X.XXX±0.010
 Millimeters: X.X±0.5 , X.XX±0.25

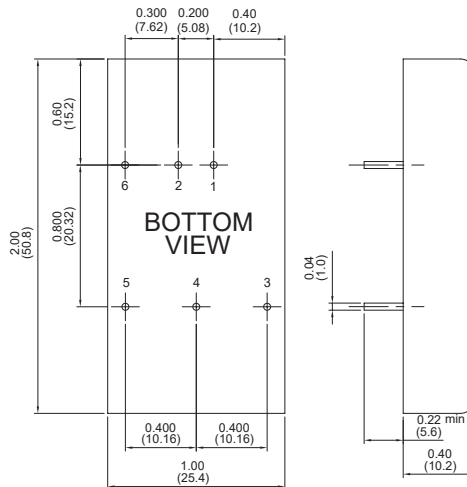

PIN CONNECTION	
Pin	Function
1	+Input
2	-Input
3	+V Output
4	Common/NP/Trim(Optional)
5	-V Output
6	NP/Remote(Optional)

* NP-NO PIN ON SINGLE OUTPUT

MODEL NUMBER	INPUT VOLTAGE	OUTPUT VOLTAGE	OUTPUT CURRENT		INPUT CURRENT		% EFF.	CAPACITOR LOAD MAX.
			MIN.	MAX.	NO LOAD	FULL LOAD		
EC4BU-05S33	4.7-9 VDC	3.3 VDC	0 mA	2500 mA	120 mA	1897 mA	87	2470µF
EC4BU-05S05	4.7-9 VDC	5 VDC	0 mA	2000 mA	120 mA	2299 mA	87	2000µF
EC4BU-05S12	4.7-9 VDC	12 VDC	0 mA	833 mA	50 mA	2298 mA	87	940µF
EC4BU-05S15	4.7-9 VDC	15 VDC	0 mA	666 mA	50 mA	2297 mA	87	690µF
EC4BU-05D05	4.7-9 VDC	±5 VDC	0 mA	±1000 mA	50 mA	2353 mA	85	1000µF
EC4BU-05D12	4.7-9 VDC	±12 VDC	0 mA	±416 mA	50 mA	2295 mA	87	440µF
EC4BU-05D15	4.7-9 VDC	±15 VDC	0 mA	±333 mA	50 mA	2297 mA	87	330µF
EC4BU-12S33	9-18 VDC	3.3 VDC	0 mA	2500 mA	30 mA	838 mA	82	2470µF
EC4BU-12S05	9-18 VDC	5 VDC	0 mA	2000 mA	30 mA	980 mA	85	2000µF
EC4BU-12S12	9-18 VDC	12 VDC	0 mA	833 mA	35 mA	957 mA	87	940µF
EC4BU-12S15	9-18 VDC	15 VDC	0 mA	666 mA	35 mA	956 mA	87	690µF
EC4BU-12D05	9-18 VDC	±5 VDC	0 mA	±1000 mA	45 mA	980 mA	85	1000µF
EC4BU-12D12	9-18 VDC	±12 VDC	0 mA	±416 mA	45 mA	957 mA	87	440µF
EC4BU-12D15	9-18 VDC	±15 VDC	0 mA	±333 mA	45 mA	957 mA	87	330µF
EC4BU-24S33	18-36 VDC	3.3 VDC	0 mA	2500 mA	25 mA	419 mA	82	2470µF
EC4BU-24S05	18-36 VDC	5 VDC	0 mA	2000 mA	25 mA	490 mA	85	2000µF
EC4BU-24S12	18-36 VDC	12 VDC	0 mA	833 mA	25 mA	478 mA	87	940µF
EC4BU-24S15	18-36 VDC	15 VDC	0 mA	666 mA	25 mA	478 mA	87	690µF
EC4BU-24D05	18-36 VDC	±5 VDC	0 mA	±1000 mA	25 mA	490 mA	85	1000µF
EC4BU-24D12	18-36 VDC	±12 VDC	0 mA	±416 mA	25 mA	478 mA	87	440µF
EC4BU-24D15	18-36 VDC	±15 VDC	0 mA	±333 mA	25 mA	478 mA	87	330µF
EC4BU-48S33	36-75 VDC	3.3 VDC	0 mA	2500 mA	20 mA	212 mA	81	2470µF
EC4BU-48S05	36-75 VDC	5 VDC	0 mA	2000 mA	20 mA	245 mA	85	2000µF
EC4BU-48S12	36-75 VDC	12 VDC	0 mA	833 mA	20 mA	239 mA	87	940µF
EC4BU-48S15	36-75 VDC	15 VDC	0 mA	666 mA	20 mA	239 mA	87	690µF
EC4BU-48D05	36-75 VDC	±5 VDC	0 mA	±1000 mA	20 mA	245 mA	85	1000µF
EC4BU-48D12	36-75 VDC	±12 VDC	0 mA	±416 mA	20 mA	239 mA	87	440µF
EC4BU-48D15	36-75 VDC	±15 VDC	0 mA	±333 mA	20 mA	239 mA	87	330µF

NOTE: 1. Nominal Input Voltage 5, 12, 24 or 48 VDC

Derating Curve

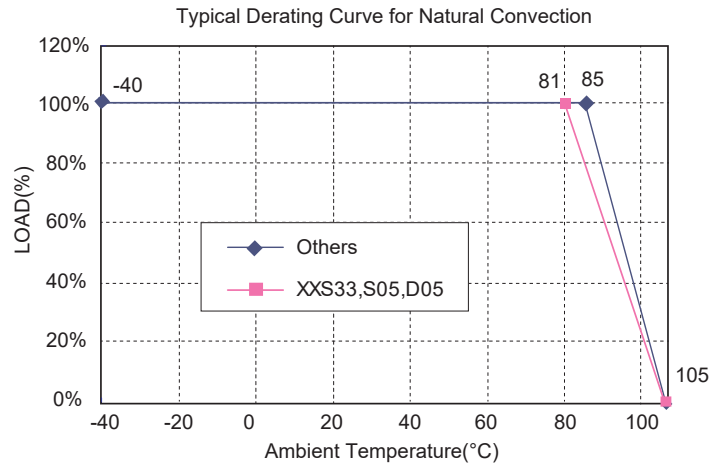

Specification

All Specifications Typical At Nominal Line, Full Load, and 25°C Unless Otherwise Noted

INPUT SPECIFICATIONS

Input Voltage Range	5V 4.7-9V
	12V 9-18V
	24V 18-36V
	48V 36-75V
Under Voltage Lockout	5Vin
	power up 4.4V
	power down 4.2V
	12Vin
	power up 8.4V
	power down 8V
	24Vin
	power up 17V
	power down 16V
	48Vin
	power up 34V
	power down 32V
Input Surge Voltage (100ms max.)	5Vin 12Vdc max.
	12Vin 25Vdc max.
	24Vin 50Vdc max.
	48Vin 100Vdc max.
Input Filter	Pi Type

OUTPUT SPECIFICATIONS

Voltage Accuracy	±1.5% max.
Voltage Balance (Dual)	±2.0% max.
Transient Response: 25% Step Load Change	< 500µs
Ripple & Noise, 20MHz BW (Measured with 0.1µF MLCC)	100mV pk-pk max.
Temperature Coefficient	±0.03%/°C
Short Circuit Protection	Continuous
Line Regulation (note1)	Single ±0.2% max.
	Dual ±0.5% max.
Load Regulation (note2)	Single ±0.2% max.
	Dual ±1.0% max.
Cross Regulation (Dual output)	
Load cross variation 10%/100%	±5% max.
Over Voltage Protection	Zener or TVS Clamp
Current Limit	110%-140% Nominal Output
Start up time	20ms max.

GENERAL SPECIFICATIONS

Efficiency	See Table
Isolation Voltage	1500 VDC min.
Isolation Resistance	10 ⁹ ohm min.
Isolation Capacitance	1000pF typ.
Switching Frequency	350KHz typ.
EMI/RFI	Conductive EMI Meets EN55022 Class A
Case Grounding	Connect Case to -Vin with Decoupling Y Cap.
Operating Ambient Temperature Range	-40°C to +85°C
Derating, Above 85°C	Linearly to Zero Power at +105°C
Case Temperature (note 4)	105°C
Cooling	Natural Convection
Storage Temperature Range	-55°C to +125°C
Humidity	95% RH max. Non condensing
MTBF MIL-STD-217-F, GB, 25°C, Full Load	1200Khrs
Dimensions	2.00 x 1.00 x 0.4 inches (50.8 x 25.4 x 10.2 mm)
Case Material	Black Coated Copper with Non- Conductive Base
Weight	35 g

OPTION

- Suffix "T" to the model number with remote positive on/off control:
Logic Compatibility: CMOS or open collector TTL, referenced to -Vin
Module On: >5.5VDC to 75VDC or open circuit
Module Off: <1.2VDC
- Suffix "A" to the model number with output voltage adjustable external trim adj. range ≅ ±10%, single output models only.

NOTE

- Measured from high line to low line.
- Measured from full load to min. load.
- Maximum case temperature under any operating condition should Not be exceeded 105°C.

EC5BE SERIES

15 WATT, 2:1 INPUT RANGE

Features

- ◆ 15W Isolated Output
- ◆ 2" x 1" Six-Sided Shield Metal Case
- ◆ Efficiency to 83%
- ◆ 2 : 1 Input Range
- ◆ Pi Input Filter
- ◆ Continuous Short Circuit Protection
- ◆ Meets EN55022 Class A, Conducted
- ◆ Remote On/Off Control (Option)
- ◆ UL60950-1 Approval

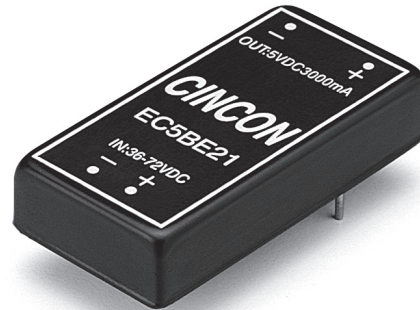

Mechanical Dimensions

NOTE: Pin Size is 0.04" ±0.004 Inch (1.0±0.1 mm) DIA
 All Dimensions in Inches (mm)
 Tolerance Inches: X.XX=±0.04, X.XXX=±0.010
 Millimeters: X.X=±0.5, X.XX=±0.25

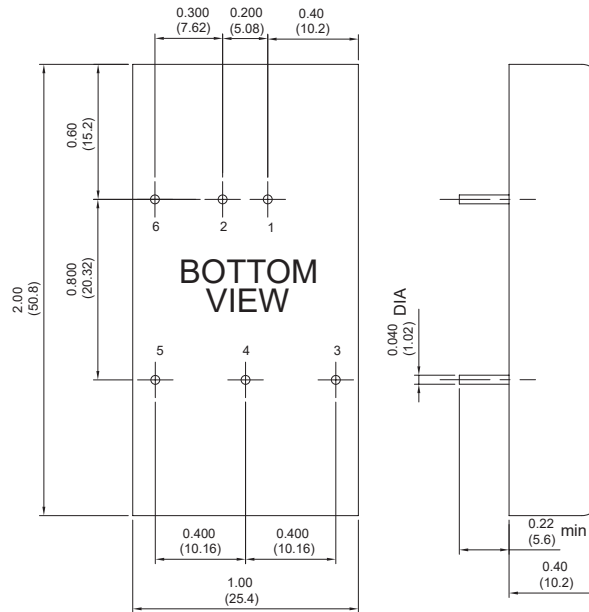

PIN CONNECTION	
Pin	Function
1	+Input
2	-Input
3	+Output
4	Common/NP/Trim(Optional)
5	-V Output
6	NP/Remote(Optional)

* NP-NO PIN ON SINGLE OUTPUT

MODEL NUMBER	INPUT VOLTAGE	OUTPUT VOLTAGE	OUTPUT CURRENT		INPUT CURRENT		% EFF.	CAPACITOR LOAD MAX.
			MIN.	MAX.	NO LOAD	FULL LOAD		
EC5BE01	9-18 VDC	5 VDC	0 mA	3000 mA	20 mA	1602 mA	78	3000µF
EC5BE02	9-18 VDC	12 VDC	0 mA	1250 mA	20 mA	1524 mA	82	1250µF
EC5BE03	9-18 VDC	15 VDC	0 mA	1000 mA	20 mA	1524 mA	82	1000µF
EC5BE04	9-18 VDC	±12 VDC	0 mA	±625 mA	30 mA	1506 mA	83	625µF
EC5BE05	9-18 VDC	±15 VDC	0 mA	±500 mA	30 mA	1506 mA	83	500µF
EC5BE06	9-18 VDC	±5 VDC	0 mA	±1500 mA	30 mA	1563 mA	80	1500µF
EC5BE07	9-18 VDC	3.3 VDC	0 mA	3000 mA	20 mA	1086 mA	76	3000µF
EC5BE11	18-36 VDC	5 VDC	0 mA	3000 mA	20 mA	780 mA	80	3000µF
EC5BE12	18-36 VDC	12 VDC	0 mA	1250 mA	20 mA	762 mA	82	1250µF
EC5BE13	18-36 VDC	15 VDC	0 mA	1000 mA	20 mA	762 mA	82	1000µF
EC5BE14	18-36 VDC	±12 VDC	0 mA	±625 mA	25 mA	755 mA	83	625µF
EC5BE15	18-36 VDC	±15 VDC	0 mA	±500 mA	25 mA	755 mA	83	500µF
EC5BE16	18-36 VDC	±5 VDC	0 mA	±1500 mA	25 mA	772 mA	81	1500µF
EC5BE17	18-36 VDC	3.3 VDC	0 mA	3000 mA	20 mA	543 mA	76	3000µF
EC5BE21	36-72 VDC	5 VDC	0 mA	3000 mA	15 mA	391 mA	80	3000µF
EC5BE22	36-72 VDC	12 VDC	0 mA	1250 mA	15 mA	377 mA	83	1250µF
EC5BE23	36-72 VDC	15 VDC	0 mA	1000 mA	15 mA	377 mA	83	1000µF
EC5BE24	36-72 VDC	±12 VDC	0 mA	±625 mA	20 mA	377 mA	83	625µF
EC5BE25	36-72 VDC	±15 VDC	0 mA	±500 mA	20 mA	377 mA	83	500µF
EC5BE26	36-72 VDC	±5 VDC	0 mA	±1500 mA	20 mA	381 mA	82	1500µF
EC5BE27	36-72 VDC	3.3 VDC	0 mA	3000 mA	15 mA	271 mA	76	3000µF

NOTE: 1. Nominal Input Voltage 12, 24 or 48VDC

Derating Curve

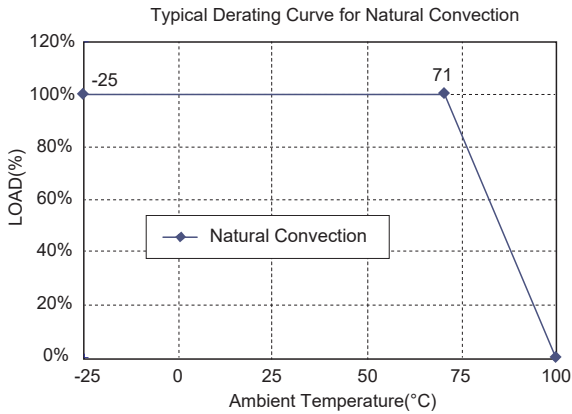

External Output Trim

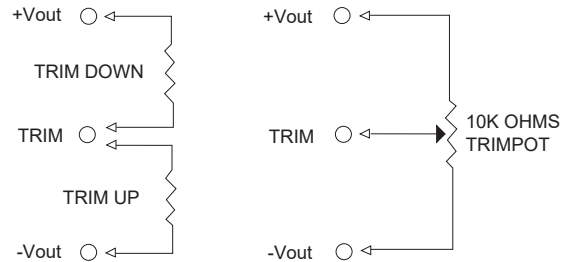

Specification

All Specifications Typical At Nominal Line, Full Load, and 25°C Unless Otherwise Noted

INPUT SPECIFICATIONS

Input Voltage Range	12V 9-18V
	24V 18-36V
	48V 36-72V
Input Surge Voltage (100ms max.)	12V 50Vdc max.
	24V 100Vdc max.
	48V 100Vdc max.
Input Filter	Pi Type

OUTPUT SPECIFICATIONS

Voltage Accuracy	±1.0% max.
Voltage Balance (Dual)	±1.0% max.
Transient Response	
Single 25% Step Load Change	< 500u sec.
Dual FL-1/2L±1% Error Band	< 500u sec.
Ripple and Noise, 20MHz BW	75mV p-p max.
Temperature Coefficient	±0.02%/°C max.
Short Circuit Protection	Continuous
Line Regulation (note 1)	±0.2% max.
Load Regulation (note 2)	±1.0% max.
Start up time	20ms typ. (ECSBE21, EC5BE27)

OPTION

- Suffix "T" to the Model Number with Remote On/Off Remote On/Off Control:

Logic Compatibility	COMS or Open Collector TTL
EC-On	>+5.5VDC or Open Circuit
EC-Off	0 to <1.8VDC
Control Common	Referenced to input Minus
- Suffix "A" to the Model Number with Output Voltage Adjustable External Trim Adj. Range $\geq \pm 10\%$, Single Output Only

GENERAL SPECIFICATIONS

Efficiency	See Table
Isolation Voltage	500 VDC min
Isolation Resistance	10 ⁸ ohms
Isolation Capacitance	500pF typ.
Switching Frequency	300KHz typ.
Operating Ambient Temperature Range	-25°C to +71°C
De-rating, Above 71°C	Linearly to Zero power at 100°C
Case Temperature (note 3)	100°C max.
Storage Temperature Range	-40°C to +100°C
Humidity	95% RH max. Non condensing
MTBF MIL-STD-217F, GB, 25°C, Full Load	1500Khrs typ.
EMI/RFI	Six sided Continuous Shield
Dimensions	2.00 x 1.00 x 0.40 inches (50.8 x 25.4 x 10.2mm)
Case Material	Black Coated Copper with Non-Conductive Base
Weight	32 g

NOTE

- Measured from high line to low line.
- Measured from full load to 1/4 load.
- Maximum case temperature under any operating condition should not be exceeded 100°C.

EC5BW SERIES

15 WATT, 4:1 INPUT RANGE

Features

- ◆ 15W Isolated Output
- ◆ Efficiency to 88%
- ◆ 2" x 1" Six-Sided Shield Metal Case
- ◆ 4 : 1 Input Range
- ◆ Regulated Outputs
- ◆ Fixed Switching Frequency
- ◆ Input Under Voltage Protection
- ◆ Over Current Protection
- ◆ Remote On/Off (Option)
- ◆ Continuous Short Circuit Protection
- ◆ No Tantalum Capacitor Inside
- ◆ Conductive EMI Meets EN55022 Class A
- ◆ CE Mark Meets 2004/108/EC
- ◆ Safety Meets UL60950-1, EN60950-1 and IEC60950-1

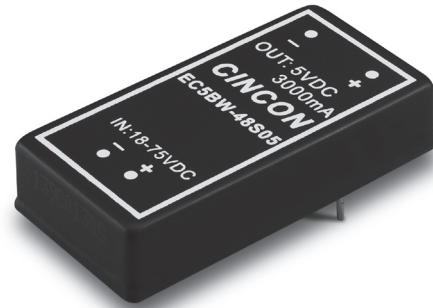

Mechanical Dimensions

NOTE: Pin Size is 0.04±0.004 Inch (1.0±0.1 mm)DIA
 All Dimensions in Inches (mm)
 Tolerance Inches: X.XX=±0.04, X.XXX=±0.010
 Millimeters: X.X=±0.5, X.XX=±0.25

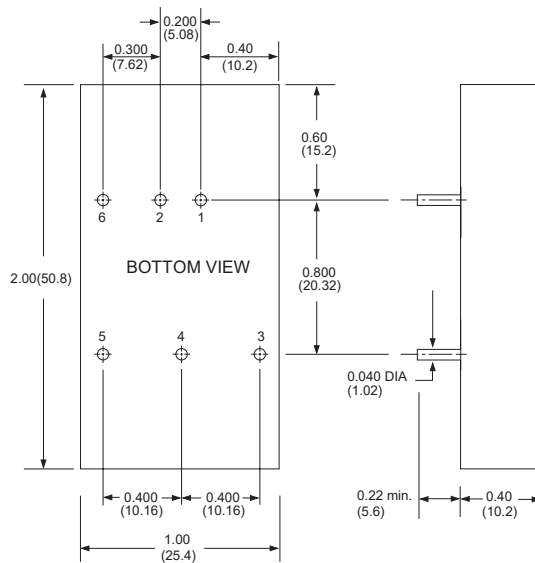

PIN CONNECTION	
Pin	Function
1	+Input
2	-Input
3	+V Output
4	Common/NP/Trim(Optional)
5	-V Output
6	NP/Remote(Optional)

* NP-NO PIN ON SINGLE OUTPUT

MODEL NUMBER	INPUT VOLTAGE	OUTPUT VOLTAGE	OUTPUT CURRENT		INPUT CURRENT		% EFF.		CAPACITOR LOAD MAX.
			MIN.	MAX.	NO LOAD	FULL LOAD	(2)	(3)	
EC5BW-24S33	9-36 VDC	3.3 VDC	0 mA	4000 mA	60 mA	632 mA	87	87	4000µF
EC5BW-24S05	9-36 VDC	5 VDC	0 mA	3000 mA	70 mA	718 mA	87	87	3000µF
EC5BW-24S12	9-36 VDC	12 VDC	0 mA	1250 mA	30 mA	718 mA	87	87	1250µF
EC5BW-24S15	9-36 VDC	15 VDC	0 mA	1000 mA	30 mA	710 mA	88	88	1000µF
EC5BW-24D05	9-36 VDC	±5 VDC	0 mA	±1500 mA	30 mA	735 mA	85	85	1500µF
EC5BW-24D12	9-36 VDC	±12 VDC	0 mA	±625 mA	30 mA	718 mA	87	87	625µF
EC5BW-24D15	9-36 VDC	±15 VDC	0 mA	±500 mA	30 mA	710 mA	88	88	470µF
EC5BW-48S33	18-75 VDC	3.3 VDC	0 mA	4000 mA	40 mA	313 mA	88	88	4000µF
EC5BW-48S05	18-75 VDC	5 VDC	0 mA	3000 mA	40 mA	355 mA	88	88	3000µF
EC5BW-48S12	18-75 VDC	12 VDC	0 mA	1250 mA	20 mA	359 mA	87	87	1250µF
EC5BW-48S15	18-75 VDC	15 VDC	0 mA	1000 mA	20 mA	359 mA	87	87	1000µF
EC5BW-48D05	18-75 VDC	±5 VDC	0 mA	±1500 mA	20 mA	368 mA	85	85	1500µF
EC5BW-48D12	18-75 VDC	±12 VDC	0 mA	±625 mA	20 mA	359 mA	87	87	625µF
EC5BW-48D15	18-75 VDC	±15 VDC	0 mA	±500 mA	20 mA	359 mA	87	87	470µF

NOTE:
 1. Nominal Input Voltage 24, 48VDC
 2. Measured at Nominal Input Voltage
 3. Measured at 12VDC for 24Vin, 24VDC for 48Vin

Derating Curve

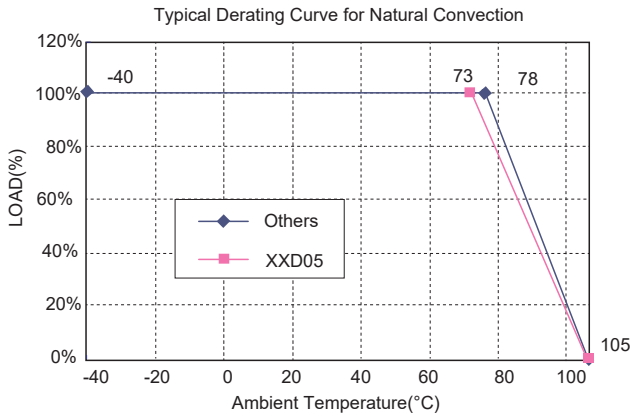

External Output Trim

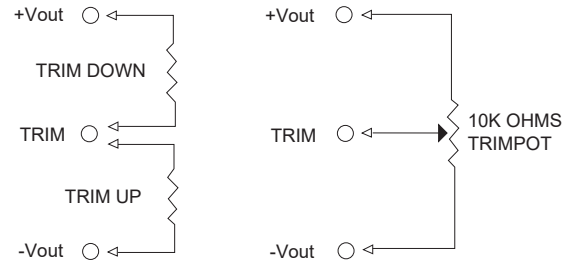

Specification

All Specifications Typical At Nominal Line, Full Load, and 25°C Unless Otherwise Noted

INPUT SPECIFICATIONS

Input Voltage Range	24VDC 9-36VDC	48VDC 18-75VDC
Input Surge Voltage (100ms max.)	24VDC 50VDC max.	48VDC 100VDC max.
Under Voltage Lockout	24Vin	Power Up 8.8VDC typ. Power Down.....8.0VDC typ.
	48Vin	Power Up.....17VDC typ. Power Down.....16VDC typ.
Input Filter	PI Type	

OUTPUT SPECIFICATIONS

Voltage Accuracy	±1.5% max.	
Voltage Balance (Dual)	±2.0% max.	
Transient Response:		
75% - 100% Step Load Change		
Error Band	±5% Vout nominal,	
Recovery Time	< 250µs	
Ripple & Noise, 20MHz BW		
(Measured with 0.1µF MLCC)		
Vo=3.3 & 5V	75mV pk-pk max.	
Vo=12V & 15V & ±12V & ±15V	100mV pk-pk max.	
Temperature Coefficient	±0.03%/C max.	
Short Circuit Protection	Continuous	
Line Regulation (note 1)	Single	±0.2% max.
	Dual	±0.5% max.
Load Regulation (note 2)	Single	±0.2% max.
	Dual	±1.0% max.
Cross Regulation (Dual Output)	±5% max.	
Load Cross Variation 10%/100%	Zener or TVS Clamp	
Over Voltage Protection	110% - 170% Nominal Output	
Current Limit	Continuous (Hiccup Mode)	
Output Short Circuit Protection	10ms typ.	
Start Up Time		

GENERAL SPECIFICATIONS

Efficiency	See Table
Isolation Voltage	1500 VDC min.
Isolation Resistance	10 ⁹ ohm min.
Isolation Capacitance	1000pF typ.
Switching Frequency	400KHz typ.
EMI/RFI	Conductive EMI Meets EN55022 Class A
Case Grounding	Connect Case to -Vin with Decoupling Y Cap
Operating Ambient Temperature Range	-40°C to +85°C
De-rating, Above 78°C	Linearly to Zero Power at +105°C
Case Temperature (note 3)	105°C
Cooling	Natural Convection
Storage Temperature Range	-55°C to +125°C
Humidity	95% RH max. Non-Condensing
MTBF.....MIL-STD-217F, GB 25C, Full Load	24(48)S33/05:940Khrs typ. Others:1305Khrs typ.
Dimensions	2.00 x 1.00 x 0.40 inches (50.8 x 25.4 x 10.2 mm)
Case Material	Black Coated Copper with Non-Conductive Base
Weight	35 g

OPTION

- Suffix "T" to the model number with remote positive On/Off control: Logic compatibility CMOS or open collector TTL, referenced to -Vin
Module On >3.5VDC to 75VDC or open circuit
Module Off < 1.2VDC
- Suffix "A" to the model number with output voltage adjustable external trim adj. Range ≥ ±10%, single output only.

NOTE:

- Measured from high line to low line.
- Measured from full load to min. load.
- Maximum case temperature under any operating condition should not be exceeded 105°C.

EC5BU SERIES

15 WATT, 2:1 INPUT RANGE

Features

- ◆ 15W Isolated Output
- ◆ Efficiency to 90%
- ◆ 2 : 1 Input Range
- ◆ Regulated Outputs
- ◆ Fixed Switching Frequency
- ◆ Input Under Voltage Protection
- ◆ Over Current Protection
- ◆ Conductive EMI Meets EN55022 Class A
- ◆ Continuous Short Circuit Protection
- ◆ Without Tantalum Capacitors Inside
- ◆ CE Mark Meets 2004/108/EC
- ◆ Safety Meets UL60950-1, EN60950-1 and IEC60950-1

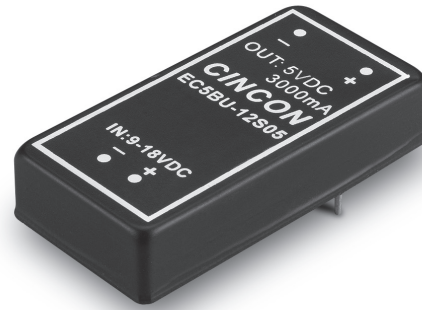

Mechanical Dimensions

NOTE: Pin Size is 0.04±0.004 Inch(1.0±0.1mm)DIA
 All Dimensions in Inches (mm)
 Tolerance Inches: X.XX±0.04 , X.XXX±0.010
 Millimeters: X.X±0.5 , X.XX±0.25

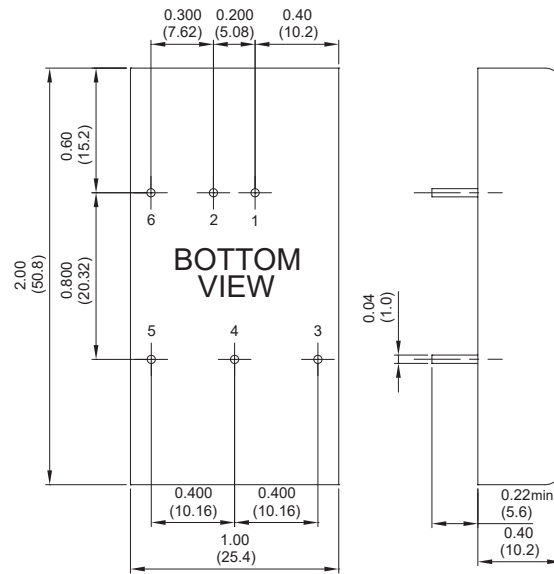

PIN CONNECTION	
Pin	Function
1	+Input
2	-Input
3	+V Output
4	Common/NP/Trim(Optional)
5	-V Output
6	NP/Remote(Optional)

* NP-NO PIN ON SINGLE OUTPUT

MODEL NUMBER	INPUT VOLTAGE	OUTPUT VOLTAGE	OUTPUT CURRENT		INPUT CURRENT		% EFF.	CAPACITOR LOAD MAX.
			MIN.	MAX.	NO LOAD	FULL LOAD		
EC5BU-12S33	9-18 VDC	3.3 VDC	0 mA	4000 mA	90 mA	1280 mA	85	4000µF
EC5BU-12S05	9-18 VDC	5 VDC	0 mA	3000 mA	85 mA	1453 mA	88	3000µF
EC5BU-12S12	9-18 VDC	12 VDC	0 mA	1250 mA	70 mA	1420 mA	88	1330µF
EC5BU-12S15	9-18 VDC	15 VDC	0 mA	1000 mA	70 mA	1420 mA	88	1000µF
EC5BU-12D05	9-18 VDC	±5 VDC	0 mA	±1500 mA	45 mA	1470 mA	85	1470µF
EC5BU-12D12	9-18 VDC	±12 VDC	0 mA	±625 mA	45 mA	1436 mA	87	660µF
EC5BU-12D15	9-18 VDC	±15 VDC	0 mA	±500 mA	45 mA	1420 mA	88	550µF
EC5BU-24S33	18-36 VDC	3.3 VDC	0 mA	4000 mA	50 mA	640 mA	86	4000µF
EC5BU-24S05	18-36 VDC	5 VDC	0 mA	3000 mA	50 mA	718 mA	89	3000µF
EC5BU-24S12	18-36 VDC	12 VDC	0 mA	1250 mA	20 mA	695 mA	90	1330µF
EC5BU-24S15	18-36 VDC	15 VDC	0 mA	1000 mA	20 mA	695 mA	90	1000µF
EC5BU-24D05	18-36 VDC	±5 VDC	0 mA	±1500 mA	25 mA	726 mA	86	1470µF
EC5BU-24D12	18-36 VDC	±12 VDC	0 mA	±625 mA	25 mA	710 mA	88	660µF
EC5BU-24D15	18-36 VDC	±15 VDC	0 mA	±500 mA	25 mA	702 mA	89	550µF
EC5BU-48S33	36-75 VDC	3.3 VDC	0 mA	4000 mA	25 mA	320 mA	86	4000µF
EC5BU-48S05	36-75 VDC	5 VDC	0 mA	3000 mA	30 mA	359 mA	88	3000µF
EC5BU-48S12	36-75 VDC	12 VDC	0 mA	1250 mA	20 mA	347 mA	90	1330µF
EC5BU-48S15	36-75 VDC	15 VDC	0 mA	1000 mA	20 mA	351 mA	90	1000µF
EC5BU-48D05	36-75 VDC	±5 VDC	0 mA	±1500 mA	20 mA	363 mA	86	1470µF
EC5BU-48D12	36-75 VDC	±12 VDC	0 mA	±625 mA	20 mA	355 mA	88	660µF
EC5BU-48D15	36-75 VDC	±15 VDC	0 mA	±500 mA	20 mA	351 mA	89	550µF

NOTE: 1. Nominal Input Voltage 12, 24 or 48 VDC

Derating Curve

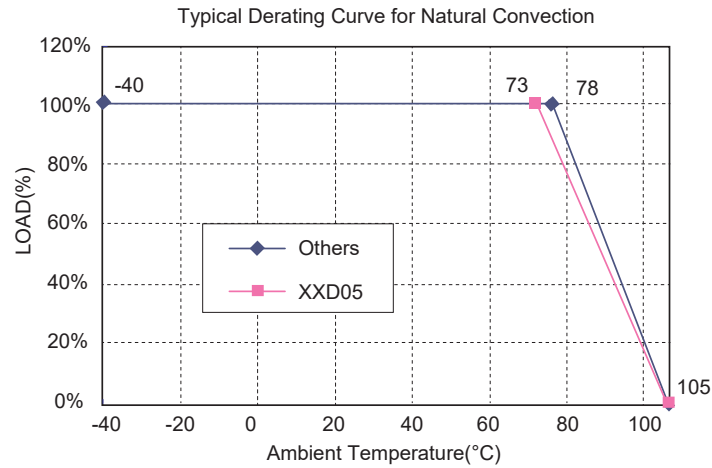

Specification

All Specifications Typical At Nominal Line, Full Load, and 25°C Unless Otherwise Noted

INPUT SPECIFICATIONS

Input Voltage Range	12V 9-18V	24V 18 -36V	48V 36-75V
Under Voltage Lockout	12Vin	power up 8.4V	power down 8V
	24Vin	power up 17V	power down 16V
	48Vin	power up 34V	power down 32V
Input Surge Voltage (100mS max.)	12Vin 25Vdc max.	24Vin 50Vdc max.	48Vin 100Vdc max.
Input Filter	Pi Type		

OUTPUT SPECIFICATIONS

Voltage Accuracy	±1.5% max.
Voltage Balance (Dual)	±2.0% max.
Transient Response: 25% Step Load Change	< 500µs
Ripple & Noise, 20MHz BW (Measured with 0.1uF MLCC)	100mV pk-pk max.
Temperature Coefficient	±0.03%/°C
Short Circuit Protection	Continuous
Line Regulation (note 1)	Single ±0.2% max.
	Dual ±0.5% max.
Load Regulation (note 2)	Single ±0.2% max.
	Dual ±1.0% max.
Cross Regulation (Dual output)	
Load cross variation 10%/100%	±5% max.
Over Voltage Protection	Zener or TVS Clamp
Current Limit	110%-140% Nominal Output
Start up time	20ms max.

GENERAL SPECIFICATIONS

Efficiency	See Table
Isolation Voltage	1500 VDC min.
Isolation Resistance	10 ⁹ ohm min.
Isolation Capacitance	1000pF typ.
Switching Frequency	350KHz typ.
EMI/RFI	Conductive EMI Meets EN55022 Class A
Case Grounding	Connect Case to -Vin with Decoupling Y Cap
Operating Ambient Temperature Range	-40°C to +85°C
Derating, Above 78°C	Linearly to Zero Power at +105°C
Case Temperature (note 4)	105°C
Cooling	Natural Convection
Storage Temperature Range	-55°C to +125°C
Humidity	95% RH max. Non condensing
MTBF MIL-STD-217-F, GB, 25°C, Full Load	1200Khrs typ.
Dimensions	2.00 x 1.00 x 0.4 inches (50.8 x 25.4 x 10.2 mm)
Case Material	Black Coated Copper with Non-Conductive Base
Weight	35 g

OPTION

- Suffix "T" to the model number with remote positive on/off control:
Logic Compatibility CMOS or Open Collector TTL, Referenced to -Vin
Module On >5.5VDC to 75VDC or open circuit
Module Off <1.2VDC
- Suffix "A" to the model number with output voltage adjustable external trim adj. range $\cong \pm 10\%$, single output models only.

NOTE

- Measured from high line to low line.
- Measured from full load to min. load.
- Maximum case temperature under any operating condition should not be exceeded 105°C.

EC7B SERIES

20 WATT, 2:1 INPUT RANGE

Features

- ◆ 20W Isolated Output
- ◆ Efficiency to 90%
- ◆ Fixed Switching Frequency
- ◆ 2 : 1 Input Range
- ◆ Regulated Outputs
- ◆ Continuous Short Circuit Protection
- ◆ Pi Input Filter
- ◆ CE Mark Meets 2004/108/EC
- ◆ UL60950-1 Approval

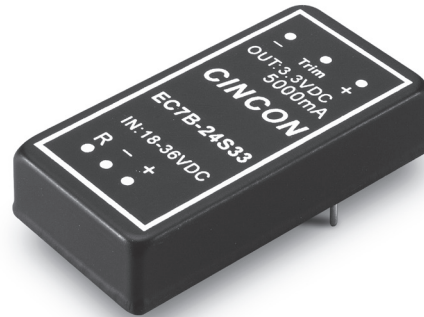

Mechanical Dimensions

NOTE: Pin Size is 0.04±0.004 Inch(1.0±0.1mm)DIA
 All Dimensions in Inches (mm)
 Tolerance Inches: X.XX±0.04 , X.XXX±0.010
 Millimeters: X.X±0.5 , X.XX±0.25

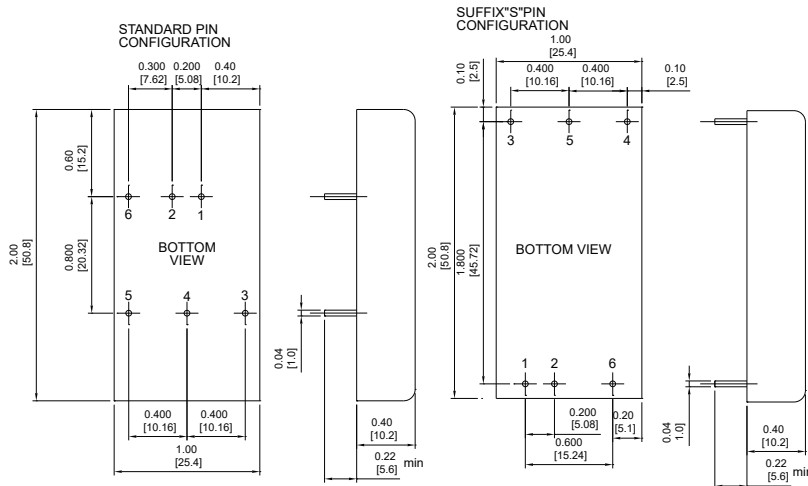

PIN CONNECTION		
PIN	Single Output	Dual Output
1	+V Input	+V Input
2	-V Input	-V Input
3	+V Output	+V Output
4	Trim	Common
5	-V Output	-V Output
6	Remote On/Off	

MODEL NUMBER	INPUT VOLTAGE	OUTPUT VOLTAGE	OUTPUT CURRENT		INPUT CURRENT		% EFF.	CAPACITOR LOAD MAX.
			MIN.	MAX.	NO LOAD	FULL LOAD		
EC7B-12D12	9-18 VDC	±12 VDC	42 mA	±835 mA	40 mA	1856 mA	90	1000µF
EC7B-12D15	9-18 VDC	±15 VDC	33 mA	±670 mA	40 mA	1861 mA	90	800µF
EC7B-24S18	18-36 VDC	1.8 VDC	0 mA	6000 mA	30 mA	523 mA	86	6000µF
EC7B-24S25	18-36 VDC	2.5 VDC	0 mA	6000 mA	30 mA	710 mA	88	6000µF
EC7B-24S33	18-36 VDC	3.3 VDC	0 mA	5000 mA	40 mA	764 mA	90	5000µF
EC7B-24S05	18-36 VDC	5 VDC	0 mA	4000 mA	60 mA	926 mA	90	4000µF
EC7B-24S12	18-36 VDC	12 VDC	0 mA	1670 mA	20 mA	928 mA	90	2000µF
EC7B-24S15	18-36 VDC	15 VDC	0 mA	1330 mA	20 mA	924 mA	90	2000µF
EC7B-24D12	18-36 VDC	±12 VDC	42 mA	±835 mA	20 mA	928 mA	90	1000µF
EC7B-24D15	18-36 VDC	±15 VDC	33 mA	±670 mA	20 mA	930 mA	90	800µF
EC7B-48S18	36-75 VDC	1.8 VDC	0 mA	6000 mA	30 mA	262 mA	86	6000µF
EC7B-48S25	36-75 VDC	2.5 VDC	0 mA	6000 mA	30 mA	359 mA	87	6000µF
EC7B-48S33	36-75 VDC	3.3 VDC	0 mA	5000 mA	30 mA	386 mA	89	5000µF
EC7B-48S05	36-75 VDC	5 VDC	0 mA	4000 mA	40 mA	463 mA	90	4000µF
EC7B-48S12	36-75 VDC	12 VDC	0 mA	1670 mA	15 mA	469 mA	89	2000µF
EC7B-48S15	36-75 VDC	15 VDC	0 mA	1330 mA	15 mA	472 mA	88	2000µF
EC7B-48D12	36-75 VDC	±12 VDC	42 mA	±835 mA	10 mA	464 mA	90	1000µF
EC7B-48D15	36-75 VDC	±15 VDC	33 mA	±670 mA	10 mA	471 mA	89	800µF

NOTE: 1. Nominal Input Voltage 12, 24, 48VDC

Derating Curve

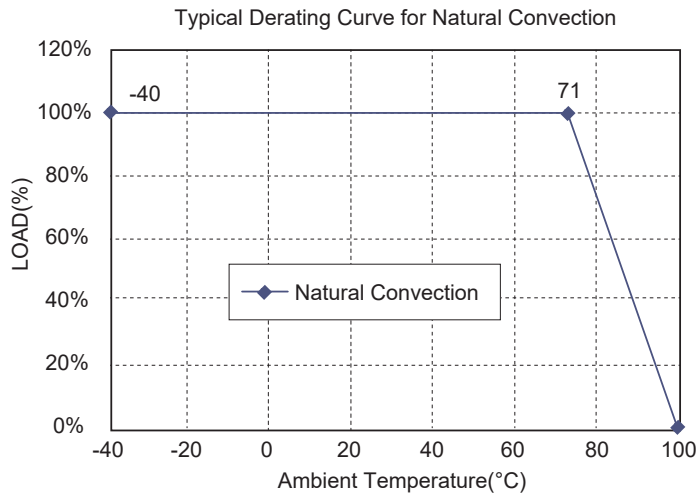

Specification

All Specifications Typical At Nominal Line, Full Load, and 25°C Unless Otherwise Noted

INPUT SPECIFICATIONS

Input Voltage Range	12V 9-18V	24V 18-36V	48V 36-75V	
Input Surge Voltage (100ms max.)	12V 25Vdc max.	24V 50Vdc max.	48V 100Vdc max.	
Under Voltage Lockout	12Vin	power up 8.8V power down 8.0V	24Vin	power up 17V power down 16V
	48Vin	power up 34V power down 33V		
Positive Logic Remote On/Off (see note 3 & 4)				
Input Filter	Pi Type			

OUTPUT SPECIFICATIONS

Voltage Accuracy	±1.5% max.
Voltage Balance (Dual)	±2.0% max.
Transient Response: 75% - 100% Step Load Change	
Error Band	±5% Vout nominal,
Recovery Time	< 500µs
Ripple & Noise, 20MHz BW (Measured with 0.1µF MLCC)	75mVpk-pk, max.
Temperature Coefficient	±0.03%/°C
Line Regulation (note 1)	Single ±0.2% max. Dual ±0.5% max.
Load Regulation (note 2)	Single/Dual ±1.0% max.
Over Voltage Protection	Zener or TVS Clamp
Output Short Circuit Protection	Continuous
External Trim Adj. Range	Single ±10%
Start up time	EC7B-24S12/15 13ms typ. EC7B-48S12/15 22ms typ. Other: 5ms typ.

GENERAL SPECIFICATIONS

Efficiency	See Table
Isolation Voltage	Input/Output 1500VDC max.
Isolation Resistance	10 ⁸ ohm min.
Isolation Capacitance	1000pF typ.
Switching Frequency	350KHz typ.
EMI/RFI	Six Sided Continuous Shield
Operating Ambient Temperature	-40°C to +85°C
De-rating, Above 71°C	Linearly to Zero power at 100°C
Case Temperature (note 6)	100°C max.
Cooling	Natural Convection
Storage Temperature	-55°C to +125°C
Humidity	95% RH max. Non condensing
MTBF MIL-STD-217F, GB, 25°C, Full Load	
	Single 900Khrs typ.
	Dual 740Khrs typ.
Dimensions	2.00 x 1.00 x 0.40 inches (50.8 x 25.4 x 10.2 mm)
Case Material	Black Coated Copper with Non-Conductive Base
Weight	35 g

NOTE

1. Measured from high line to low line.
2. Measured from full load to 10% load.
3. Logic compatibility CMOS or open collector TTL, ref. to -Vin
Module On >5.5VDC or open circuit
Module Off < 1.2VDC
4. Suffix "N" to the model number with negative logic remote on/off
Module On < 1.2VDC
Module Off >5.5VDC or open circuit
5. Suffix "S" to the model number with alternative pin configuration, single output models only.
6. Maximum case temperature under any operating condition should not be exceeded 100°C.

EC7BW SERIES

20 WATT, 4 : 1 INPUT RANGE

Features

- ◆ 20W Isolated Output
- ◆ 2" x 1" x 0.4" Shielded Metal Case
- ◆ Efficiency to 90%
- ◆ Fixed Switching Frequency
- ◆ 4 : 1 Wide Input Range
- ◆ Regulated Outputs
- ◆ Continuous Short Circuit Protection
- ◆ Pi Input Filter
- ◆ Safety Meets UL60950-1, EN60950-1, and IEC60950-1
- ◆ Meets EN50155 with External Circuits
- ◆ Shock & Vibration Meets EN50155 (EN61373)
- ◆ Fire & Smoke meet EN45545-2

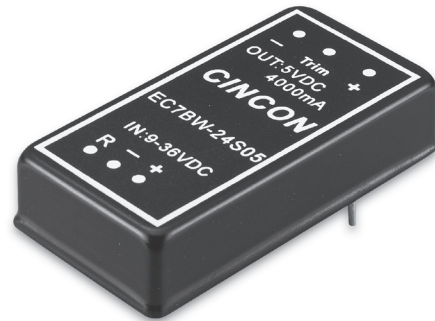

Mechanical Dimensions

All Dimensions in Inches (mm)
 Tolerance Inches: X.XX=±0.04, X.XXX=±0.010
 Millimeters: X.X=±0.5, X.XX=±0.25

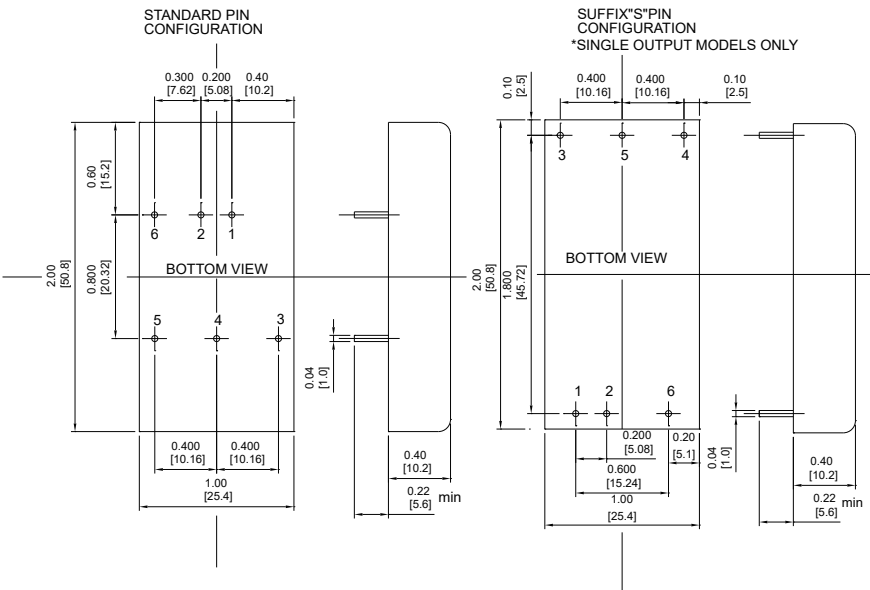

PIN CONNECTION		
PIN	Single Output	Dual Output
1	+V Input	+V Input
2	-V Input	-V Input
3	+V Output	+V Output
4	Trim	Common
5	-V Output	-V Output
6	Remote On/Off	

MODEL NUMBER	INPUT VOLTAGE	OUTPUT VOLTAGE	OUTPUT CURRENT		INPUT CURRENT		% EFF.	CAPACITOR LOAD MAX.
			MIN.	MAX.	NO LOAD	FULL LOAD		
EC7BW-24S33	9-36 VDC	3.3 VDC	0 mA	5500 mA	55 mA	869 mA	87	5500µF
EC7BW-24S05	9-36 VDC	5 VDC	0 mA	4000 mA	55 mA	926 mA	90	4000µF
EC7BW-24S12	9-36 VDC	12 VDC	0 mA	1670 mA	55 mA	928 mA	90	1800µF
EC7BW-24S15	9-36 VDC	15 VDC	0 mA	1330 mA	55 mA	924 mA	90	1500µF
EC7BW-24D05	9-36 VDC	± 5 VDC	0 mA	±2000 mA	70 mA	937 mA	89	2000µF
EC7BW-24D12	9-36 VDC	± 12 VDC	0 mA	±835 mA	35 mA	947 mA	88	1000µF
EC7BW-24D15	9-36 VDC	± 15 VDC	0 mA	±666 mA	35 mA	947 mA	88	800µF
EC7BW-48S33	18-75 VDC	3.3 VDC	0 mA	5500 mA	25 mA	430 mA	88	5500µF
EC7BW-48S05	18-75 VDC	5 VDC	0 mA	4000 mA	25 mA	463 mA	90	4000µF
EC7BW-48S12	18-75 VDC	12 VDC	0 mA	1670 mA	25 mA	464 mA	90	1800µF
EC7BW-48S15	18-75 VDC	15 VDC	0 mA	1330 mA	25 mA	462 mA	90	1500µF
EC7BW-48D05	18-75 VDC	± 5 VDC	0 mA	±2000 mA	35 mA	468 mA	89	2000µF
EC7BW-48D12	18-75 VDC	± 12 VDC	0 mA	±835 mA	25 mA	474 mA	88	1000µF
EC7BW-48D15	18-75 VDC	± 15 VDC	0 mA	±666 mA	25 mA	474 mA	88	800µF

NOTE: 1. Nominal Input Voltage 24, 48VDC

Derating Curve

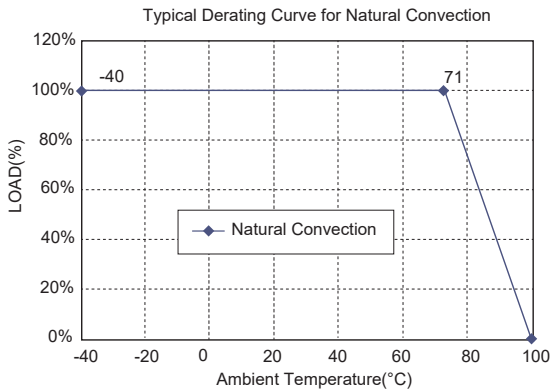

External Output Trim

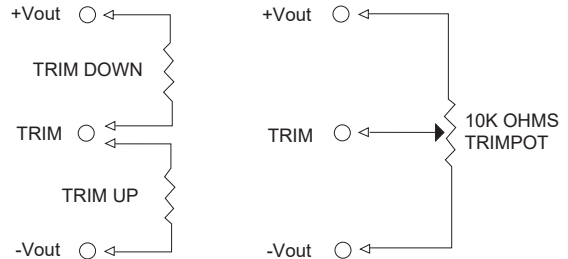

Specification

All Specifications Typical At Nominal Line, Full Load, and 25°C Unless Otherwise Noted

INPUT SPECIFICATIONS

Input Voltage Range	24V 9-36V	48V 18-75V
Input Surge Voltage (100ms max.)	24V 50Vdc max.	48V 100Vdc max.
Under voltage lockout	24Vin	power up 8.8V typ. power down 8.0V typ.
	48Vin	power up 17V typ. power down 16V typ.
Positive Logic Remote On/Off (note 3 & 4)		
Input Filter	PI Type	

OUTPUT SPECIFICATIONS

Voltage Accuracy	±1.5% max.
Voltage Balance (Dual Output)	±1.0% max.
Transient Response: 75%-100% Step Load Change	
Error Band	±5% Vout Nominal
Recovery Time	< 500µs
Ripple & Noise, 20MHz BW (Measured with 0.1µF MLCC)	75mV pk-pk, max.
Temperature Coefficient	±0.03%/°C
Line Regulation (note 1)	Single ±0.2% max. Dual ±0.5% max.
Load Regulation (note 2)	±1.0% max.
Cross Regulation (Dual output)	
Load cross variation 25%/100%	±5.0% max. Over Voltage
Protection	Zener or TVS Clamp
Output Short Circuit Protection	Continuous
External Trim Adj. Range (Single Output Models only)	±10%
Start up time	5ms typ.

GENERAL SPECIFICATIONS

Efficiency	See Table
Isolation Voltage	Input/Output 1500VDC max.
Isolation Resistance	10 ⁸ ohm min.
Isolation Capacitance	1000pF typ.
Switching Frequency	Single 50KHz typ. Dual 400KHz typ.
EMI/RFI	Six Sided Continuous Shield
Operating Ambient Temperature	-40°C to +85°C
De-rating, Above 71°C	Linearly to Zero power at 105°C
Case Temperature (note 6)	105°C max.
Storage Temperature	-55°C to +125°C
Humidity	95% RH max. Non condensing
MTBF MIL-STD-217F, GB, 25°C, Full Load	720Khrs typ.
Dimensions	2.00 x 1.00 x 0.40 inches (50.8 x 25.4 x 10.2 mm)
Case Material	Black Coated Copper with Non-Conductive Base
Weight	35 g

NOTE

1. Measured from high line to low line.
2. Measured from full load to zero load.
3. Logic compatibility CMOS or open collector TTL, ref. to -Vin
Module On >5.5VDC to 75VDC or open circuit
Module Off 0 to <1.2VDC
4. Suffix "N" to the model number with negative logic remote on/off
Module On 0 to <1.2VDC
Module Off >5.5VDC to 75VDC or open circuit
5. Suffix "S" to the model number with alternative pin configuration, single output models only.
6. Maximum case temperature under any operating condition should not be exceeded 105°C.

EC7BW-110 SERIES

20 WATT, INPUT 43-160 VDC

Features

- ◆ 20W Isolated Output
- ◆ Efficiency to 90%
- ◆ 250KHz Switching Frequency
- ◆ 4 : 1 Input Range
- ◆ Regulated Outputs
- ◆ Remote On/Off
- ◆ Low No Load Power Consumption
- ◆ Continuous Short Circuit Protection
- ◆ 2" x 1" x 0.4" Size Meets Industrial Standard
- ◆ UL60950-1 (Basic Insulation) Approval
- ◆ Meets EN50155
- ◆ Fire & Smoke meet EN45545-2



Mechanical Dimensions

NOTE: Pin Size is 0.04±0.004 Inch (1.0±0.1 mm)DIA
 All Dimensions in Inches (mm)
 Tolerance Inches: X.XX±0.04 , X.XXX±0.010
 Millimeters: X.X±0.5 , X.XX±0.25

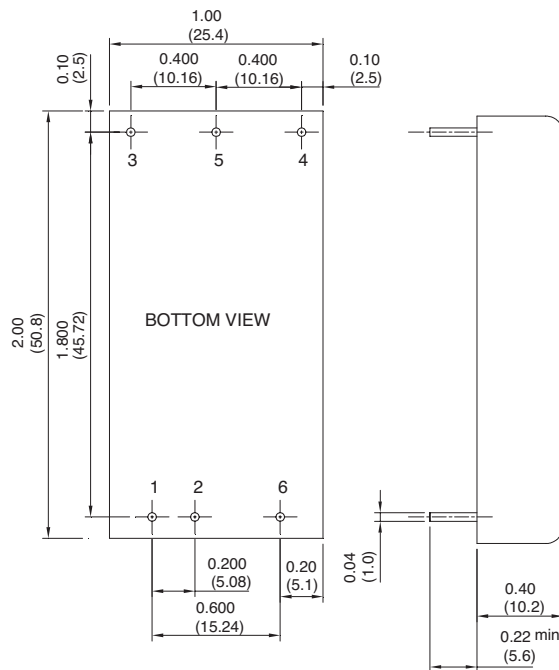

PIN CONNECTION		
PIN	Single Output	Dual Output
1	+V Input	+V Input
2	-V Input	-V Input
3	+V Output	+V Output
4	Trim	-V Output
5	-V Output	Common
6	Remote On/Off	

MODEL NUMBER	INPUT VOLTAGE	OUTPUT VOLTAGE	OUTPUT CURRENT		INPUT CURRENT		% EFF.	CAPACITOR LOAD MAX.
			MIN.	MAX.	NO LOAD	FULL LOAD		
EC7BW-110S05	43-160 VDC	5 VDC	0 mA	4000 mA	3 mA	205.4 mA	88.5	5600µF
EC7BW-110S12	43-160 VDC	12 VDC	0 mA	1670 mA	3 mA	202.0 mA	90	1000µF
EC7BW-110S15	43-160 VDC	15 VDC	0 mA	1330 mA	3 mA	203.1 mA	89.5	1000µF
EC7BW-110D12	43-160 VDC	±12 VDC	0 mA	±833 mA	3 mA	204.3 mA	89	680µF
EC7BW-110D15	43-160 VDC	±15 VDC	0 mA	±667 mA	3 mA	205.4 mA	88.5	350µF

NOTE: 1. Nominal Input Voltage 110VDC

Derating Curve

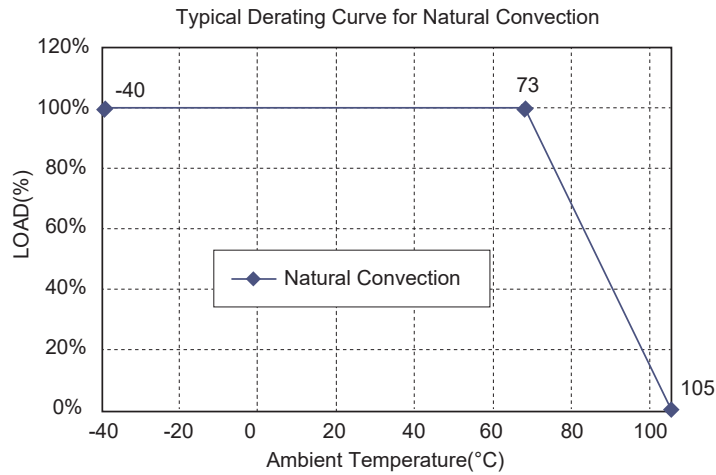

Specification

All Specifications Typical At Nominal Line, Full Load, and 25°C Unless Otherwise Noted

INPUT SPECIFICATIONS

Input Voltage Range	110V 43-160V
Input Surge Voltage (100ms max.)	200Vdc max.
Under Voltage Lockout	Power up 40V
	Power down 38V
Positive Logic Remote On/Off (note 4 & 5)	
Input Filter	Pi Type

OUTPUT SPECIFICATIONS

Voltage Accuracy	±1.5% max.
Voltage Balance (Dual Output)	±1.0% max.
Transient Response: 25% Step Load Change	< 250µs
External Trim Adj. Range	
(Single Output Models Only)	±10%
Ripple & Noise, 20MHz BW (note 3)	5V 40mV RMS, max.
	75mV pk-pk, max.
	12V & 15V & ±12V &
	±15V 40mV RMS, max.
	100mV pk-pk, max.
Temperature Coefficient	±0.03%/°C
Short Circuit Protection	Continuous
Line Regulation (note 1)	±0.2% max.
Load Regulation (note 2)	Single ±0.5% max.
	Dual ±1.0% max.
Cross Regulation (Dual output)	
Load cross variation 10%/100%	±5.0% max.
Over Voltage Protection	Zener or TVS Clamp
Current Limit	110%-160% Nominal Output
Start up time	Single 15ms typ.
	Dual 25ms typ.

GENERAL SPECIFICATIONS

Efficiency	See Table
Isolation Voltage	Input/Output 3000VDC min.
Isolation Resistance	10 ⁹ ohm min.
Isolation Capacitance	1000pF typ.
Switching Frequency	250KHz typ.
EMI/RFI	Conductive EMI Meets EN55022 Class A
Operating Ambient Temperature	-40°C to +85°C
De-rating, Above 73°C	Linearly to Zero power at 105°C
Case Temperature	105°C max.
Storage Temperature	-55°C to +125°C
Humidity	95% RH max. Non condensing
MTBF MIL-HDBK-217F, GB, 25°C, Full Load	TBD hrs typ.
Safety	UL60950-1 2nd (Basic insulation)
EMC (note 6)	meet EN50155 (EN50121-3-2) with external filter
Shock/Vibration	meet EN50155 (EN61373)
Dimensions	2.00 x 1.00 x 0.40 inches (50.8 x 25.4 x 10.2 mm)
Case Material	Black Coated Copper with Non-Conductive Base
Weight	35 g

NOTE

1. Measured from high line to low line.
2. Measured from full load to zero load.
3. Output ripple and noise measured with 1µF ceramic capacitor across output.
4. Logic compatibility open collector ref. to -Input
Module On > 3.5VDC to 75VDC or open circuit
Module Off < 1.2VDC
5. Suffix "N" to the model number with negative logic remote on/off
Module On < 1.2VDC
Module Off >3.5VDC to 75VDC or open circuit
6. Design meet EN50155 and RIA12 refer to application note.

EC7BW18 SERIES

20 WATT 18:1 INPUT DC-DC CONVERTERS

Features

- ◆ 20W Isolated Output
- ◆ Efficiency Up to 90%
- ◆ Fixed Switching Frequency
- ◆ 18:1 Input Range
- ◆ Regulated Outputs
- ◆ Remote On/Off
- ◆ Low No Load Power Consumption
- ◆ Over Voltage/Current Protection
- ◆ Continuous Short Circuit Protection
- ◆ 2"x1"x0.4" Size Meet Industrial Standard
- ◆ Meet UL62368-1 (Reinforce Insulation)
- ◆ Meet EN50155 with External Circuits
- ◆ Shock & Vibration Meets EN50155 (EN61373)
- ◆ Fire & Smoke Meet EN45545-2
- ◆ 5000m Operating Altitude

Preliminary



Mechanical Dimensions

NOTE: Pin Size is 0.04±0.004 Inch (1.0±0.1 mm)DIA
 All Dimensions In Inches (mm)
 Tolerances Inches: X.XX= ±0.02 , X.XXX= ±0.010
 Millimeters: X.X= ±1.0, X.XX= ±0.25

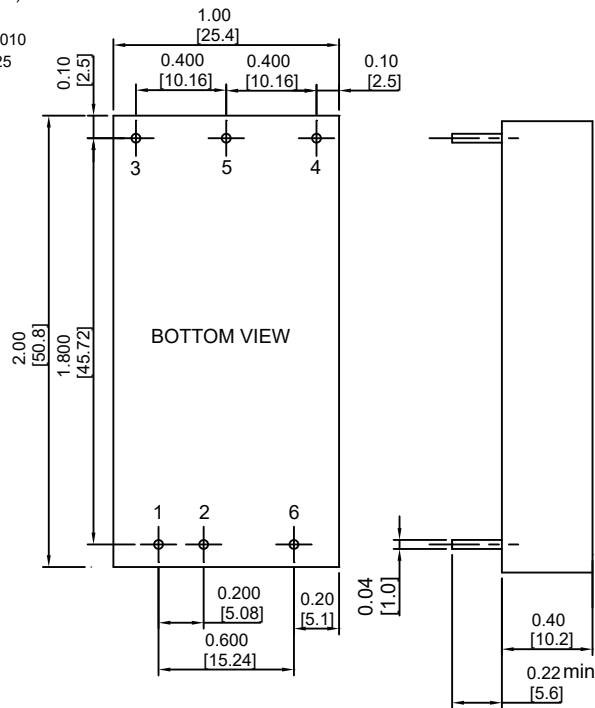

PIN CONNECTION		
PIN	Single	Dual
1	+V Input	+V Input
2	-V Input	-V Input
3	+V Output	+V Output
4	Trim	-V Output
5	-V Output	Common
6	Remote ON/OFF	

MODEL NUMBER	INPUT VOLTAGE(3)	OUTPUT VOLTAGE	OUTPUT CURRENT		INPUT CURRENT		% EFF.		CAPACITOR LOAD MAX.
			MIN.	MAX.	NO LOAD	FULL LOAD	(1)	(2)	
EC7BW18-72S05	8.5-160 VDC	5 VDC	0 mA	4000 mA	5 mA	323 mA	86	85	5600uF
EC7BW18-72S12	8.5-160 VDC	12 VDC	0 mA	1670 mA	8 mA	315 mA	88	89	3300uF
EC7BW18-72S15	8.5-160 VDC	15 VDC	0 mA	1330 mA	8 mA	312 mA	89	88	2200uF
EC7BW18-72D12	8.5-160 VDC	±12 VDC	0 mA	±833 mA	8 mA	312 mA	89	88	820uF
EC7BW18-72D15	8.5-160 VDC	±15 VDC	0 mA	±667 mA	8 mA	312 mA	89	89	680uF
EC7BW18-72D24	8.5-160 VDC	±24 VDC	0 mA	±417 mA	8 mA	309 mA	90	89	330uF

NOTE: 1. Measured at Nominal Input Voltage 72VDC
 2. Measured at Input Voltage 110VDC
 3. EC7BW18 has De-rating by Input Voltage is required. Shown below.

Derating Curve

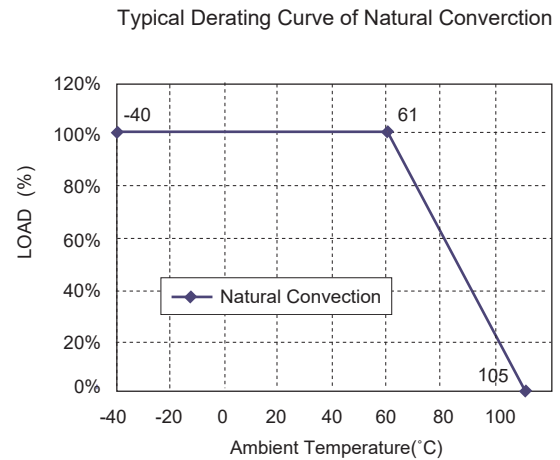
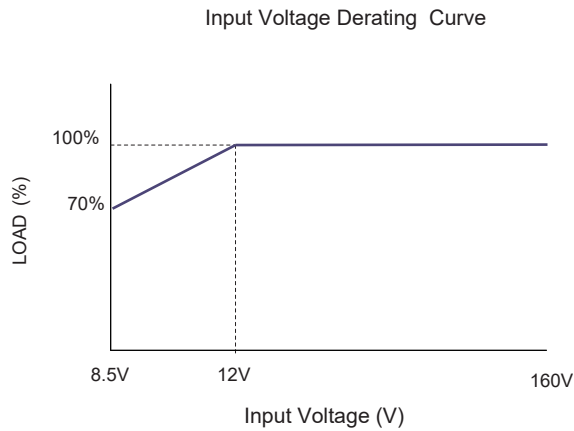

External Output Trim

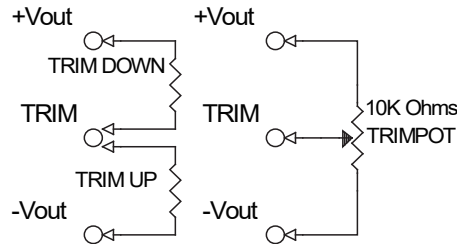

Specifications

All Specifications Typical At Nominal Line, Full Load, and 25°C Unless Otherwise Noted

INPUT SPECIFICATIONS

Input Voltage Range	72V.....8.5V-160V
Input Surge Voltage (100ms max.)	200Vdc max.
Under Voltage Lockout	Power up 9.0V Power down.....7.5V
Positive Logic Remote On/Off	See note 4 & 5
Input Filter	PI Type

OUTPUT SPECIFICATIONS

Voltage Accuracy:	±1.0% max.
Voltage Balance (Dual Output)	±1.0% max.
Transient Response: 75%~100% Step Load Change	±5% Vout nominal,
Error Band	<250us
Recovery Time	-20%,+15%
External Trim Adj. Range (Single Output Models Only)	
Ripple & Noise, 20MHz BW (note 3)	40mV RMS, max.
5V	75mV pk-pk, max.
Other	40mV RMS, max.
	100mV pk-pk, max.
Temperature Coefficient	±0.02%/°C
Short Circuit Protection	Continuous
Line Regulation (note 1)	±0.2% max
Load Regulation (note 2)	
Single	±0.2% max
Dual	±1.0% max
Cross Regulation (Dual output)	±5.0% max
Load cross variation 25%/100%	
Over Voltage Protection	Zener Clamp
Current Limit	110%-180% Nominal Output
Start up time	10ms typ.

GENERAL SPECIFICATIONS

Efficiency	See Table
Isolation Voltage	3000VAC min.
Isolation Resistance	10 ⁹ ohm min.
Isolation Capacitance	20pF typ.
Switching Frequency	200KHz typ.
Operating Ambient Temperature	-40°C to +85°C
De-rating, Above 61°C	Linearly to Zero power at 105°C
Case Temperature	105°C max.
Storage Temperature	-55°C to +125°C
Humidity	95% RH max. Non condensing
Operating Altitude	5000m
MTBF MIL-HDBK-217F, GB, 25°C, Full Load	TBD
Safety	Meet UL62368-1 (Reinforce insulation)
EMC (note6)	Meet EN50155(EN50121-3-2) with external filter
Shock/Vibration	Meet EN50155(EN61373)
Environmental	EN50155(EN60068-2-1)
Fire & Smoke	Meet EN45545-2
Dimensions	2.00x1.00x0.40 inches (50.8x25.4x10.2 mm)
Case Material	Non-Conductive Black Plastic
Weight	TBD

NOTE

1. Measured from high line to low line.
2. Measured from full load to zero load.
3. Output ripple and noise measured with 1uF ceramic capacitor across output.
4. Logic compatibility open collector ref. to -Input
Module on > 4.0VDC to 160VDC or open circuit
Module off 0 to < 1.2VDC
5. Suffix "N" to the model number with negative logic remote on/off
Module on 0 to < 1.2VDC
Module off > 4.0VDC to 160VDC or open circuit
6. Design meet EN50155 and RIA12 refer to application note.

EC9BW SERIES

30 WATT, 4:1 INPUT RANGE

Features

- ◆ 30W Isolated Output
- ◆ Efficiency to 92%
- ◆ 2" x 1" Six-Sided Shield Metal Case
- ◆ 4 : 1 Input Range
- ◆ Regulated Outputs
- ◆ Fixed Switching Frequency
- ◆ Input Under Voltage Protection
- ◆ Over Current Protection
- ◆ Remote On/Off
- ◆ Continuous Short Circuit Protection
- ◆ No Tantalum Capacitor Inside
- ◆ CE Mark Meets 2004/108/EC
- ◆ Safety Meets UL60950-1, EN60950-1, and IEC60950-1



Mechanical Dimensions

NOTE: Pin Size is 0.04±0.004 Inch (1.0±0.1 mm)DIA
 All Dimensions in Inches (mm)
 Tolerance Inches: X.XX=±0.04 , X.XXX=±0.010
 Millimeters: X.X=±0.5 , X.XX=±0.25

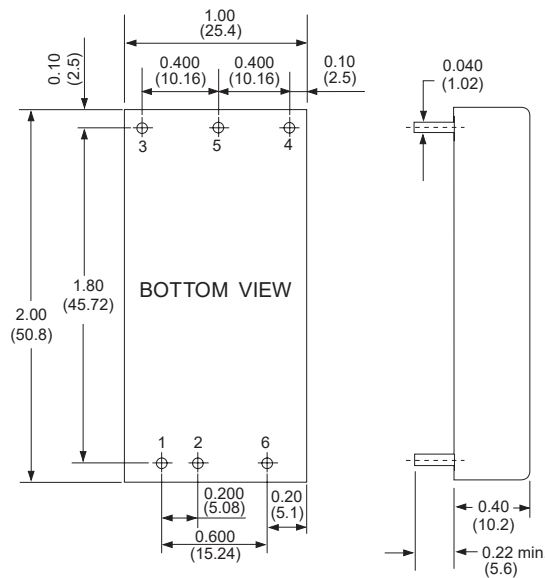

PIN CONNECTION		
PIN	Single Output	Dual Output
1	+V Input	+V Input
2	-V Input	-V Input
3	+V Output	+V Output
4	Trim	-V Output
5	-V Output	Common
6	Remote On/Off	

MODEL NUMBER	INPUT VOLTAGE	OUTPUT VOLTAGE	OUTPUT CURRENT		INPUT CURRENT		% EFF.		CAPACITOR LOAD MAX.
			MIN.	MAX.	NO LOAD	FULL LOAD	(2)	(3)	
EC9BW-24S33	9-36 VDC	3.3 VDC	0 mA	7500 mA	100 mA	1172 mA	88	88.5	7500µF
EC9BW-24S05	9-36 VDC	5 VDC	0 mA	6000 mA	110 mA	1397 mA	89.5	89.5	6000µF
EC9BW-24S12	9-36 VDC	12 VDC	0 mA	2500 mA	50 mA	1374 mA	91	90.5	2500µF
EC9BW-24S15	9-36 VDC	15 VDC	0 mA	2000 mA	50 mA	1374 mA	91	90.5	2000µF
EC9BW-24D12	9-36 VDC	±12 VDC	0 mA	±1250 mA	60 mA	1374 mA	91	90.5	1250µF
EC9BW-24D15	9-36 VDC	±15 VDC	0 mA	±1000 mA	60 mA	1359 mA	92	91	1000µF
EC9BW-48S33	18-75 VDC	3.3 VDC	0 mA	7500 mA	50 mA	593 mA	87	87.5	7500µF
EC9BW-48S05	18-75 VDC	5 VDC	0 mA	6000 mA	50 mA	694 mA	89.5	90	6000µF
EC9BW-48S12	18-75 VDC	12 VDC	0 mA	2500 mA	30 mA	683 mA	91.5	90	2500µF
EC9BW-48S15	18-75 VDC	15 VDC	0 mA	2000 mA	30 mA	679 mA	92	91	2000µF
EC9BW-48D12	18-75 VDC	±12 VDC	0 mA	±1250m A	40 mA	683 mA	91.5	90.5	1250µF
EC9BW-48D15	18-75 VDC	±15 VDC	0 mA	±1000m A	40 mA	679 mA	92	91	1000µF

NOTE:

1. Nominal Input Voltage 24 or 48 VDC
2. Measured at 12VDC for 24Vin, 24VDC for 48Vin
3. Measured at Nominal Input Voltage

Derating Curve

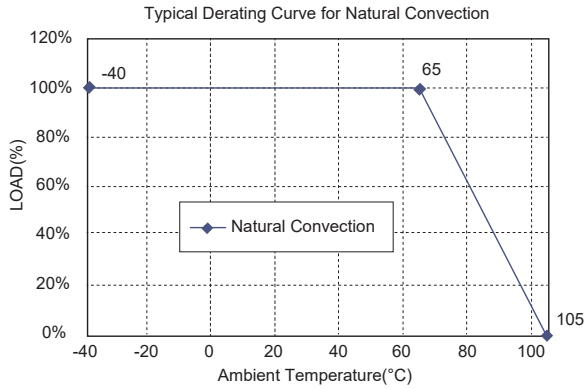

External Output Trim

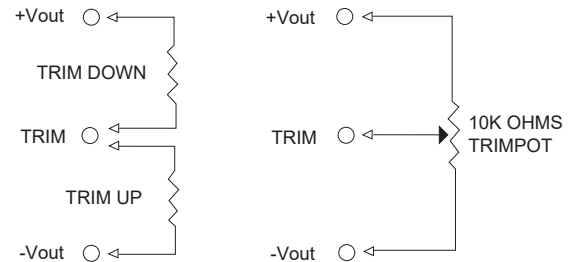

Specification

All Specifications Typical At Nominal Line, Full Load, and 25°C Unless Otherwise Noted

INPUT SPECIFICATIONS

Input Voltage Range	24VDC 9-36VDC	48VDC 18-75VDC
Input Surge Voltage (100ms max.)	24VDC 50VDC max.	48VDC 100VDC max.
Under Voltage Lockout	24Vin	Power Up.....8.8VDC typ. Power Down.....8.0VDC typ.
	48Vin	Power Up.....17VDC typ. Power Down.....16VDC typ.
Input Filter	PI Type	
Positive Logic Remote on/off Control (note 3 & 4)		

OUTPUT SPECIFICATIONS

Voltage Accuracy		±1% max.
Voltage Balance (Dual)		±1% max.
Transient Response: 75% - 100% Step Load Change		
Error Band		±5% Vout nominal,
Recovery Time		< 250µs
Ripple & Noise, 20MHz BW (Measured with 0.1µF MLCC)		
	Vo=3.3 & 5V	75mV pk-pk max.
	Vo=12V & 15V & ±12V & ±15V	100mV pk-pk max.
Temperature Coefficient		
Line Regulation (note 1)	Single	±0.2% max.
	Dual	±0.5% max.
Load Regulation (note 2)	Single	±0.5% max.
	Dual	±1.0% max.
Cross Regulation (Dual Output)		
Load Cross Variation 10%/100%		±5% max.
Over Voltage Protection		Zener or TVS Clamp
Current Limit		110% - 160% Nominal Output
Output Short Circuit Protection		Continuous (Hiccup Mode)
External Trim Adj. Range (Single Output Models Only)		
		±10%
Start Up Time		5ms typ.

GENERAL SPECIFICATIONS

Efficiency		See Table
Isolation Voltage		1500 VDC min.
Isolation Resistance		10 ⁹ ohm min.
Isolation Capacitance		1000pF typ.
Switching Frequency		430KHz typ.
EMI/RFI		Six-Sided Continuous Shield
Operating Ambient Temperature Range		-40°C to +85°C
De-rating, Above 65°C		Linearly to Zero Power at +105°C
Case Temperature (note 5)		105°C max.
Cooling		Natural Convection
Storage Temperature Range		-55°C to +125°C
Thermal Shutdown, Case Temp.		110°C typ.
Humidity		95% RH max. Non-Condensing
MTBF ... MIL-STD-217F, GB, 25°C, Full Load	Single	900Khrs typ.
	Dual	650Khrs typ.
Dimensions		2.00 x 1.00 x 0.40 inches (50.8 x 25.4 x 10.2 mm)
Case Material		Black Coated Copper with Non-Conductive Base
Weight		35 g

NOTE

- Measured from high line to low line.
- Measured from full load to min. load.
- Logic compatibility CMOS or open collector TTL, referenced to -Vin.
Module On >3.5VDC to 75VDC or open circuit
Module Off <1.2VDC
- Suffix "N" to the model number with negative logic remote on/off
Module On <1.2VDC
Module Off >3.5VDC to 75VDC or open circuit
- Maximum case temperature under any operating condition should not be exceeded 105°C.

ECLB40W SERIES

40 WATT, 4:1 INPUT RANGE

Features

- ◆ 40W Isolated Output
- ◆ Efficiency to 91%
- ◆ 2.05" x 1.2" x 0.4" Six-Sided Shield Metal Case
- ◆ 4 : 1 Input Range
- ◆ Regulated Outputs
- ◆ Fixed Switching Frequency
- ◆ Low No Load Power Consumption
- ◆ Input Under Voltage Protection
- ◆ Over Current Protection
- ◆ Remote On/Off
- ◆ Continuous Short Circuit Protection
- ◆ No Tantalum Capacitor Inside
- ◆ Safety Meets UL60950-1, EN60950-1, and IEC60950-1



Mechanical Dimensions

NOTE: Pin Size is 0.04±0.004 Inch (1.0±0.1 mm)DIA
 All Dimensions in Inches (mm)
 Tolerance Inches: X.XX=±0.04 , X.XXX=±0.010
 Millimeters: X.X=±0.5 , X.XX=±0.25

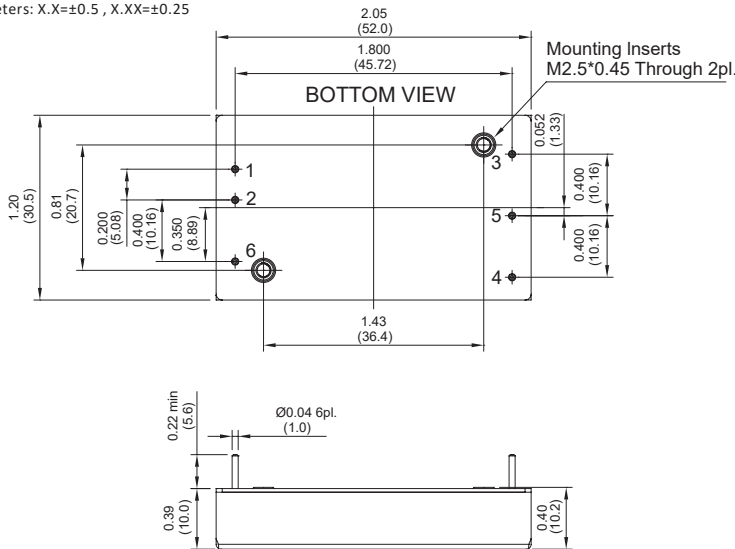

PIN CONNECTION		
PIN	Single Output	Dual Output
1	+V Input	+V Input
2	-V Input	-V Input
3	+V Output	+V Output
4	Trim	-V Output
5	-V Output	Common
6	Remote On/Off	

MODEL NUMBER	INPUT VOLTAGE	OUTPUT VOLTAGE	OUTPUT CURRENT		INPUT CURRENT		% EFF.		CAPACITOR LOAD MAX.
			MIN.	MAX.	NO LOAD	FULL LOAD	(3)	(2)	
ECLB40W-24S33	9-36 VDC	3.3 VDC	0 mA	10000 mA	8 mA	1528 mA	88.5	90	10000µF
ECLB40W-24S05	9-36 VDC	5 VDC	0 mA	8000 mA	8 mA	1842 mA	89.5	90.5	8000µF
ECLB40W-24S12	9-36 VDC	12 VDC	0 mA	3333 mA	10 mA	1832 mA	90.5	91	3300µF
ECLB40W-24S15	9-36 VDC	15 VDC	0 mA	2666 mA	10 mA	1842 mA	90.5	90.5	2700µF
ECLB40W-24D12	9-36 VDC	±12 VDC	0 mA	±1667 mA	10 mA	1873 mA	89.5	89	1650µF
ECLB40W-24D15	9-36 VDC	±15 VDC	0 mA	±1333 mA	10 mA	1862 mA	90	89.5	1350µF
ECLB40W-48S33	18-75 VDC	3.3 VDC	0 mA	10000 mA	6 mA	764 mA	89	90	10000µF
ECLB40W-48S05	18-75 VDC	5 VDC	0 mA	8000 mA	6 mA	921 mA	90	90.5	8000µF
ECLB40W-48S12	18-75 VDC	12 VDC	0 mA	3333 mA	8 mA	921 mA	91.5	90.5	3300µF
ECLB40W-48S15	18-75 VDC	15 VDC	0 mA	2666 mA	8 mA	921 mA	91	90.5	2700µF
ECLB40W-48D12	18-75 VDC	±12 VDC	0 mA	±1667 mA	8 mA	932 mA	90	89.5	1650µF
ECLB40W-48D15	18-75 VDC	±15 VDC	0 mA	±1333 mA	8 mA	926 mA	90.5	90	1350µF

NOTE:
 1. Nominal Input Voltage 24 or 48 VDC
 2. Measured at Nominal Input Voltage
 3. Measured at 12VDC for 24Vin, 24VDC for 48Vin

Derating Curve

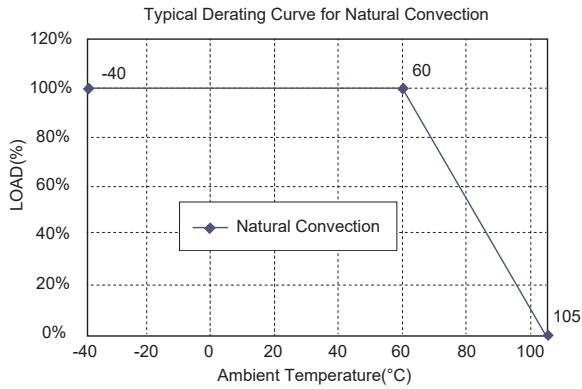

External Output Trim

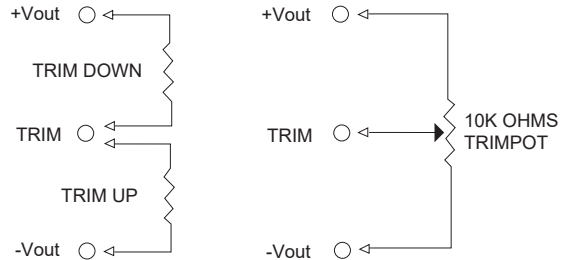

Specification

All Specifications Typical At Nominal Line, Full Load, and 25°C Unless Otherwise Noted

INPUT SPECIFICATIONS

Input Voltage Range	24VDC.....9-36VDC	48VDC.....18-75VDC
Input Surge Voltage (100ms max.)	24VDC.....50VDC max.	48VDC.....100VDC max.
Under Voltage Lockout	24Vin	Power Up.....8.5VDC typ. Power Down.....8.0VDC typ.
	48Vin	Power Up.....17VDC typ. Power Down.....16VDC typ.
Input Filter	PI Type	
Remote On/Off Control (note3)		

OUTPUT SPECIFICATIONS

Voltage Accuracy	±1.5% max.
Voltage Balance (Dual)	±1% max.
Transient Response: 75% - 100% Step Load Change	
Error Band	±5% Vout nominal
Recovery Time	< 250µs
Ripple & Noise, 20MHz BW (Measured with 1µF MLCC)	
Vo=3.3 & 5V	100mV pk-pk max.
Vo=12V & 15V & ±12V & ±15V	150mV pk-pk max.
Temperature Coefficient	±0.02%/°C max.
Line Regulation (note 1)	±0.2% max.
Load Regulation (note 2)	±0.5% max.
Cross Regulation (Dual Output)	
Load Cross Variation 10%/100%	±5% max.
Over Voltage Protection	Zener or TVS Clamp
Current Limit	110% - 165% Nominal Output
Output Short Circuit Protection	Continuous (Hiccup Mode)
External Trim Adj. Range (Single Output Models Only)	±10%
Start Up Time	15ms typ.

GENERAL SPECIFICATIONS

Efficiency	See Table
Isolation Voltage	Input/Output.....1500VDC min. Input/Case, Output/Case..... 1000VDC min. 10 ⁹ ohm min.
Isolation Resistance	Input/Output..... 1500pF typ.
Isolation Capacitance	Input/Case.....1000pF typ. Output/Case.....1000pF typ.
Switching Frequency	300KHz typ.
EMI/RFI	Six-Sided Continuous Shield
Operating Ambient Temperature Range	-40°C to +85°C
De-rating, Above 60°C	Linearly to Zero Power at +105°C
Case Temperature (note 4)	105°C max.
Cooling	Natural Convection
Storage Temperature Range	-55°C to +125°C
Thermal Shutdown, Case Temp.	110°C typ.
Humidity	95% RH max. Non-Condensing
MTBF MIL-STD-217F, GB, 25°C, Full Load	1400Khrs typ.
Dimensions	2.05 x 1.20 x 0.40 inches (52 x 30.5 x 10.2 mm)
Case Material	Aluminum with Non-Conductive Base
Weight	36 g

NOTE

1. Measured from high line to low line.
2. Measured from full load to min. load.
3. Logic compatibility ... CMOS or open collector TTL, refer to -Vin.
Module On >3.5VDC to 75VDC or open circuit
Module Off 0 to <1.2VDC
4. Maximum case temperature under any operating condition should not be exceeded 105°C.

ECLB40W-110 SERIES

40 WATT, INPUT RANGE 43-160 VDC

Features

- ◆ 40W Isolated Output
- ◆ Efficiency to 91%
- ◆ 2.05" x 1.2" x 0.4" Six-Sided Shield Metal Case
- ◆ 4 : 1 Input Range
- ◆ Regulated Outputs
- ◆ Fixed Switching Frequency
- ◆ Input Under Voltage Protection
- ◆ Over Current Protection
- ◆ Remote On/Off
- ◆ Low No Load Power Consumption
- ◆ Continuous Short Circuit Protection
- ◆ No Tantalum Capacitor Inside
- ◆ Safety standard: UL 60950-1 2nd (basic insulation)
- ◆ EMC: EN 50155 (EN 50121-3-2), external filter required
- ◆ Shock & Vibration: EN 50155 (EN 61373)
- ◆ UL60950-1 2nd (Basic Insulation) Approval
- ◆ Meets EN50155 with External Circuits
- ◆ Fire & Smoke Meets EN45545-2
- ◆ 3000m Operating Altitude
- ◆ Full Load Operation Up to 69°C with Heat-Sink M-C655 Natural Convection



Mechanical Dimensions

NOTE: Pin Size is 0.04±0.004 Inch (1.0±0.1 mm)DIA
 All Dimensions in Inches (mm)
 Tolerance Inches: X.XX±0.02 , X.XXX±0.010
 Millimeters: X.X±0.5 , X.XX±0.25

PIN CONNECTION		
PIN	Single Output	Dual Output
1	+V Input	+V Input
2	-V Input	-V Input
3	+V Output	+V Output
4	Trim	-V Output
5	-V Output	Common
6	Remote On/Off	

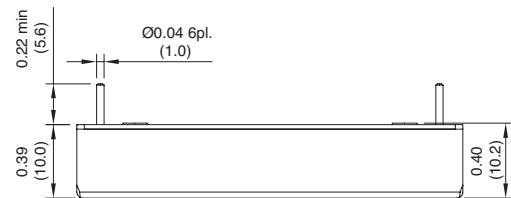
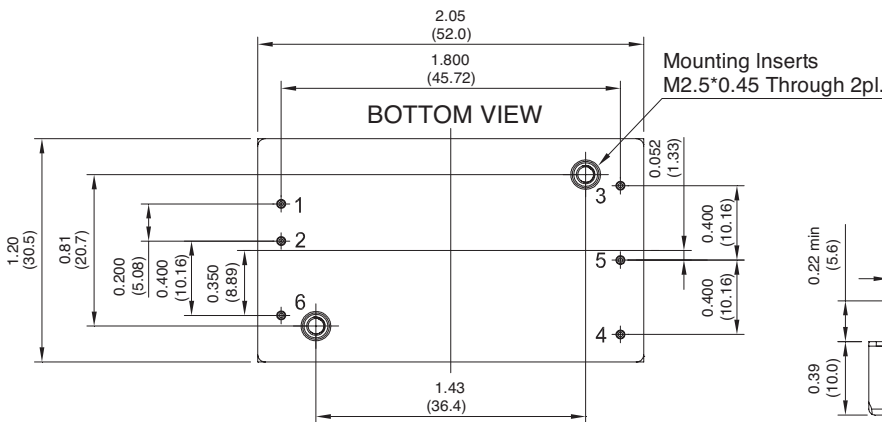

MODEL NUMBER	INPUT VOLTAGE	OUTPUT VOLTAGE	OUTPUT CURRENT		INPUT CURRENT		% EFF.	CAPACITOR LOAD MAX.
			MIN.	MAX.	NO LOAD	FULL LOAD		
ECLB40W-110S33	43-160 VDC	3.3 VDC	0 mA	10000 mA	6 mA	340 mA	88%	10000µF
ECLB40W-110S05	43-160 VDC	5 VDC	0 mA	8000 mA	6 mA	409 mA	88.5%	8000µF
ECLB40W-110S12	43-160 VDC	12 VDC	0 mA	3333 mA	6 mA	404 mA	90%	3300µF
ECLB40W-110S15	43-160 VDC	15 VDC	0 mA	2666 mA	6 mA	399 mA	91%	2700µF
ECLB40W-110D12	43-160 VDC	±12 VDC	0 mA	±1667 mA	6 mA	408 mA	88%	1650µF
ECLB40W-110D15	43-160 VDC	±15 VDC	0 mA	±1333 mA	6 mA	408 mA	88.5%	1350µF
ECLB40W-110D24	43-160 VDC	±24 VDC	0 mA	±833 mA	6 mA	408 mA	89%	850µF

NOTE: 1. Nominal Input Voltage 110 VDC

Derating Curve

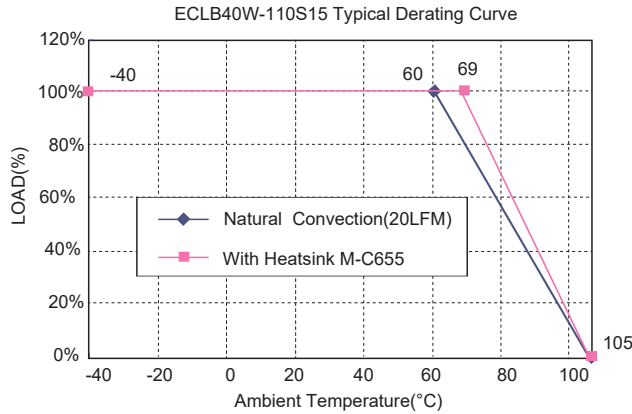

External Output Trim

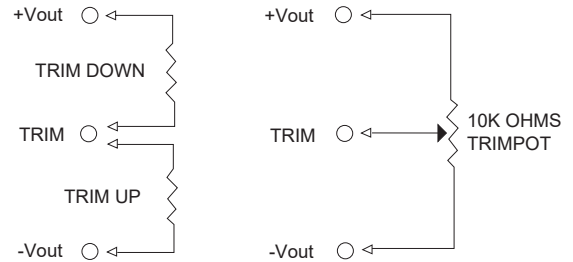

Specification

All Specifications Typical At Nominal Line, Full Load, and 25°C Unless Otherwise Noted

INPUT SPECIFICATIONS

Input Voltage Range	110V.....43-160V
Input Surge Voltage (100ms max.)	200Vdc max.
Under Voltage Lockout	Power up 40V Power down 38V
Positive Logic Remote On/Off (note 4 & 5)	
Input Filter	PI Type

OUTPUT SPECIFICATIONS

Voltage Accuracy	±1.5% max.
Voltage Balance (Dual Output)	±1.0% max.
Transient Response:	
25% Step Load Change	Error Band +/--5% Vout Nominal, Recovery Time < 250µs
External Trim Adj. Range (Single Output Models Only)	±10%
Ripple & Noise, 20MHz BW (Measured with 1µF MLCC)	
Vo= 3.3V & 5V	100mV pk-pk max.
Vo= 12V, 15V, ±12V & ±15V	150mV pk-pk max.
Vo= ±24V	200mV pk-pk max.
Temperature Coefficient	±0.02%/°C max.
Short Circuit Protection	Continuous
Line Regulation (note 1)	±0.2% max.
Load Regulation (note 2)	Single ±0.5% max. Dual ±1.0% max.
Cross Regulation (Dual output)	
Load cross variation 10%/100%	±5.0% max.
Over Voltage Protection	Zener or TVS Clamp
Current Limit	110%-165% Nominal Output
Start up time	15ms typ.

GENERAL SPECIFICATIONS

Efficiency	See Table
Isolation Voltage	Input/Output 3000VDC min. Input/Case 1600VDC min. Output/Case 1600VDC min. 10 ⁹ ohms min.
Isolation Resistance	1500pF typ.
Isolation Capacitance	Output/case 1000pF typ.
Case grounding	250KHz typ.
Switching Frequency	Six-Sided Continuous Shield
EMI/RFI	-40°C to +85°C
Operating Ambient Temperature Range	Linearly to Zero Power at +105°C
De-rating, Above 45°C	105°C max.
Case Temperature (note 5)	Natural Convection
Cooling	-55°C to +125°C
Storage Temperature Range	110°C typ.
Thermal Shutdown, Case Temp	95% RH max. Non-Condensing
Humidity	905Khrs typ.
MTBFMIL-STD-217F, GB, 25°C, Full Load	UL60950-1 2 nd (Basic insulation)
Safety	EN50155 (EN50121-3-2)
EMC (note 6)	with external filter
	EN50155 (EN61373)
Shock/Vibration	2.05 x 1.20 x 0.40 inches
Dimensions	(52.0 x 30.5 x 10.2 mm)
Case Material	Aluminum with
	Non-Conductive Base
Weight	36 g

NOTE

- Measured from high line to low line.
- Measured from full load to min. load.
- Logic Compatibility ... CMOS or Open Collector TTL, Referenced to -Vin.
Module On >3.5VDC to 75VDC or Open Circuit
Module Off 0 to <1.2VDC
- Suffix "N" to the model number with negative logic remote On/Off
Module On..... 0 to <1.2VDC
Module Off>3.5VDC to 75VDC or Open Circuit
- Maximum case temperature under any operating condition should not be exceeded 105°C.
- For information about EN50155 and RIA12, refer to application note.

ECLB60W SERIES

60 WATT, 4:1 INPUT RANGE

Features

- ◆ 60W Isolated Output
- ◆ Efficiency to 92%
- ◆ Low No Load Power Consumption
- ◆ 2.05" x 1.2" x 0.4" Six-Sided Shield Metal Case
- ◆ 4 : 1 Input Range
- ◆ Regulated Outputs
- ◆ Fixed Switching Frequency
- ◆ Input Under Voltage Protection
- ◆ Over Current Protection
- ◆ Remote On/Off
- ◆ Continuous Short Circuit Protection
- ◆ No Tantalum Capacitor Inside
- ◆ Safety Meets UL60950-1, EN60950-1, and IEC60950-1
- ◆ Full Load Operation Up to 60°C with Heat-Sink M-C655 Natural Convection



Mechanical Dimensions

NOTE: Pin Size is 0.04±0.004 Inch (1.0±0.1 mm)DIA
 All Dimensions in Inches (mm)
 Tolerance Inches: X.XX=±0.02 , X.XXX=±0.010
 Millimeters: X.X=±0.5 , X.XX=±0.25

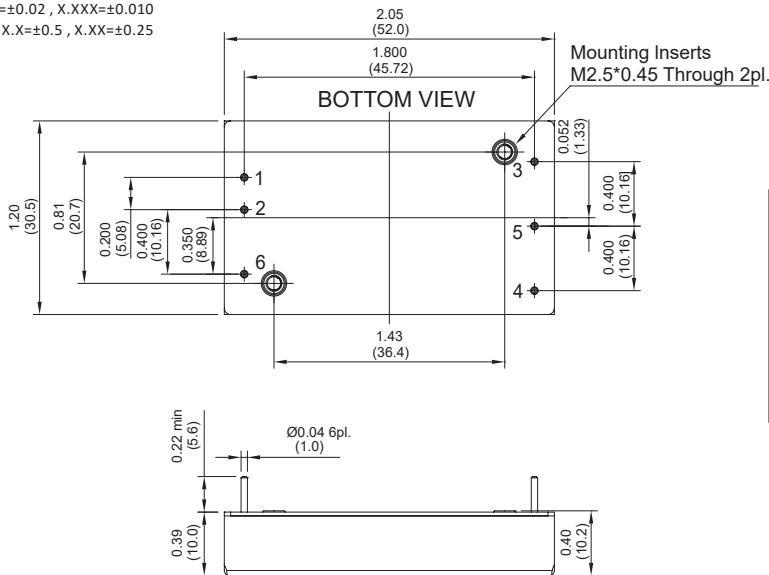

PIN CONNECTION		
PIN	Single Output	Dual Output
1	+V Input	+V Input
2	-V Input	-V Input
3	+V Output	+V Output
4	Trim	-V Output
5	-V Output	Common
6	Remote On/Off	

MODEL NUMBER	INPUT VOLTAGE	OUTPUT VOLTAGE	OUTPUT CURRENT		INPUT CURRENT		% EFF.		CAPACITOR LOAD MAX.
			MIN.	MAX.	NO LOAD	FULL LOAD	(3)	(2)	
ECLB60W-24S33	9-36 VDC	3.3 VDC	0 mA	15000 mA	10 mA	2279 mA	90.5	90	15000µF
ECLB60W-24S05	9-36 VDC	5 VDC	0 mA	12000 mA	10 mA	2717 mA	92	92	12000µF
ECLB60W-24S12	9-36 VDC	12 VDC	0 mA	5000 mA	10 mA	2717 mA	92.5	92	5000µF
ECLB60W-24S15	9-36 VDC	15 VDC	0 mA	4000 mA	10 mA	2717 mA	92	91	4000µF
ECLB60W-24D12	9-36 VDC	±12 VDC	0 mA	±2500 mA	12 mA	2747 mA	91	91	2500µF
ECLB60W-24D15	9-36 VDC	±15 VDC	0 mA	±2000 mA	12 mA	2747 mA	92	91	2000µF
ECLB60W-48S33	18-75 VDC	3.3 VDC	0 mA	15000 mA	8 mA	1140 mA	91	90.5	15000µF
ECLB60W-48S05	18-75 VDC	5 VDC	0 mA	12000 mA	8 mA	1359 mA	92	92	12000µF
ECLB60W-48S12	18-75 VDC	12 VDC	0 mA	5000 mA	8 mA	1359 mA	92.5	92	5000µF
ECLB60W-48S15	18-75 VDC	15 VDC	0 mA	4000 mA	8 mA	1359 mA	92	91	4000µF
ECLB60W-48D12	18-75 VDC	±12 VDC	0 mA	±2500 mA	8 mA	1374 mA	91	91	2500µF
ECLB60W-48D15	18-75 VDC	±15 VDC	0 mA	±2000 mA	8 mA	1374 mA	92	91	2000µF

Derating Curve

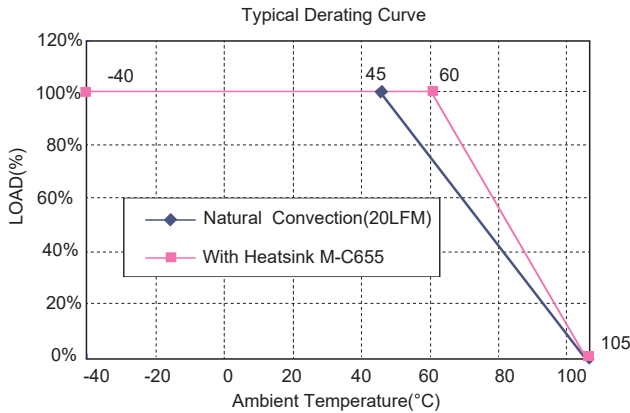

External Output Trim

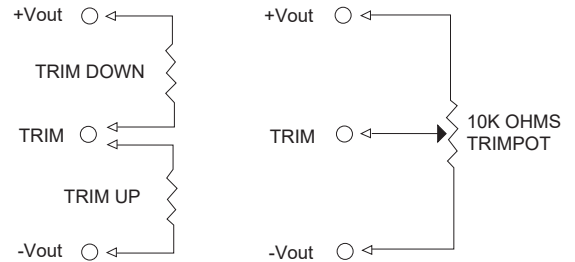

Specification

All Specifications Typical At Nominal Line, Full Load, and 25°C Unless Otherwise Noted

INPUT SPECIFICATIONS

Input Voltage Range	24VDC 9-36VDC	48VDC 18-75VDC
Input Surge Voltage (100ms max.)	24VDC 50VDC max.	48VDC 100VDC max.
Under Voltage Lockout	24Vin	Power Up.....8.5VDC typ. Power Down.....8.0VDC typ.
	48Vin	Power Up.....17VDC typ. Power Down.....16VDC typ.
Input Filter	PI Type	
Remote On/Off Control (note 3)		

OUTPUT SPECIFICATIONS

Voltage Accuracy	±1.5% max.
Voltage Balance (Dual)	±1% max.
Transient Response: 75% - 100% Step Load Change	
Error Band	±5% Vout nominal
Recovery Time	< 250µs
Ripple & Noise, 20MHz BW (Measured with 1µF MLCC)	
Vo=3.3 & 5V	100mV pk-pk max.
Vo=12V & 15V & ±12V & ±15V	150mV pk-pk max.
Temperature Coefficient .	±0.02%/°C max.
Line Regulation (note 1)	Single/Dual ±0.2% max.
Load Regulation (note 2)	Single/Dual ±0.5% max.
Cross Regulation (Dual Output)	
Load Cross Variation 10%/100%	±5% max.
Over Voltage Protection	Zener or TVS Clamp
Current Limit	110% - 170% Nominal Output
Output Short Circuit Protection	Continuous (Hiccup Mode)
External Trim Adj. Range (Single Output Models Only)	±10%
Start Up Time	30ms typ.

GENERAL SPECIFICATIONS

Efficiency	See Table
Isolation Voltage	Input/Output 1500VDC min. Input/Case, Output/ Case ... 1000VDC min.
Isolation Resistance	10 ⁹ ohm min.
Isolation Capacitance	Input/Output 1500pF typ. Input/Case 1000pF typ. Output/Case 1000pF typ. Single..... 245KHz typ. Dual..... 300KHz typ.
Switching Frequency	Single..... 245KHz typ. Dual..... 300KHz typ.
EMI/RFI	Six-Sided Continuous Shield
Operating Ambient Temperature Range .	-40°C to +85°C
De-rating, Above 45°C (note 5)	Linearly to Zero Power at +105°C
Case Temperature (note 5)	105°C max.
Cooling	Natural Convection
Storage Temperature Range	-55°C to +125°C
Thermal Shutdown, Case Temp.	110°C typ.
Humidity .	95% RH max. Non-Condensing
MTBF ... MIL-STD-217F, GB, 25°C, Full Load	Vo=3.3V 1116Khrs typ. Vo=5V 872Khrs typ., Vo=12V 930Khrs typ., Vo=15V 1230Khrs typ. Vo=±12V 859Khrs typ., Vo=±15V 1063Khrs typ.
Shock/Vibration	Meet MIL-STD-810F
Dimensions	2.05 x 1.20 x 0.40 inches (52 x 30.5 x 10.2 mm)
Case Material	Aluminum with Non-Conductive Base
Weight	39 g

NOTE

1. Measured from high line to low line.
2. Measured from full load to min. load.
3. Logic compatibility ... CMOS or open collector TTL, referenced to -Vin.
Module On.....>3.5VDC to 75VDC or open circuit
Module Off.....0 to < 1.2VDC
4. Suffix "N" to the model number with negative logic remote on/off
Module on 0 to < 1.2 VDC
Module off >3.5VDC to 75VDC or open circuit
5. Maximum case temperature under any operating condition should not be exceeded 105°C.
6. Refer application note Item 6.2.

ECLB75W SERIES

75 WATT 4:1 INPUT DC-DC CONVERTERS

Features

- ◆ 75W Isolated Output
- ◆ Efficiency Up to 92.5%
- ◆ Low No Load Power Consumption
- ◆ 2.05"x1.2x0.4" Six-Sided Shield Metal Case
- ◆ 4:1 Input Ranges
- ◆ Regulated Outputs
- ◆ Fixed Switching Frequency
- ◆ Input Under Voltage Protection
- ◆ Over Current Protection
- ◆ Remote On/Off
- ◆ Continuous Short Circuit Protection
- ◆ No Tantalum Capacitor Inside
- ◆ Safety Meets UL62368, EN62368, and IEC62368
- ◆ Full Load Operation Up to 59°C with Heat-Sink LBT127(M-C655)
Natural Convection

Preliminary



Mechanical Dimensions

CASE LB
All Dimensions in Inches[mm]
Tolerance Inches:x.xx=±0.02 ,x.xxx=±0.010
Millimeters:x.x=±0.5 , x.xx=±0.25

PIN CONNECTION		
PIN	Single Output	Dual Output
1	+V Input	+V Input
2	-V Input	-V Input
3	+V Output	+V Output
4	Trim	-V Output
5	-V Output	Common
6	Remote ON/OFF	
7	NP	Trim

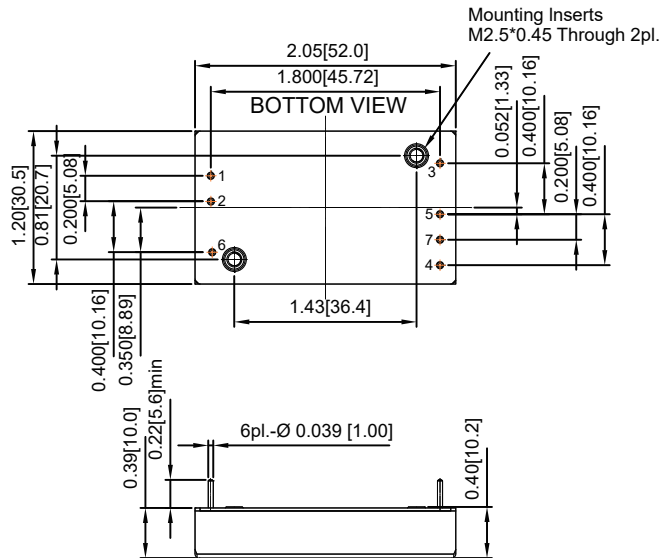

MODEL NUMBER	INPUT VOLTAGE	OUTPUT VOLTAGE	OUTPUT CURRENT		INPUT CURRENT		% EFF.		CAPACITOR LOAD MAX.
			MIN.	MAX.	NO LOAD	FULL LOAD	(3)	(2)	
ECLB75W-24S05	9-36 VDC	5 VDC	0 mA	15000 mA	10 mA	3415 mA	92	91.5	15000µF
ECLB75W-24S12	9-36 VDC	12 VDC	0 mA	6250 mA	10 mA	3415 mA	92	91	6250µF
ECLB75W-24S15	9-36 VDC	15 VDC	0 mA	5000 mA	10 mA	3434 mA	92	91	5000µF
ECLB75W-24D12	9-36 VDC	±12 VDC	0 mA	±3120 mA	12 mA	3453 mA	91	90.5	3200µF
ECLB75W-24D15	9-36 VDC	±15 VDC	0 mA	±2500 mA	12 mA	3453 mA	91	90.5	2500µF
ECLB75W-24D24	9-36 VDC	±24 VDC	0 mA	±1560 mA	18 mA	3453 mA	91	90.5	1560µF
ECLB75W-48S05	18-75 VDC	5 VDC	0 mA	15000 mA	8 mA	1700 mA	92	91.5	15000µF
ECLB75W-48S12	18-75 VDC	12 VDC	0 mA	6250 mA	8 mA	1700 mA	92.5	91.5	6250µF
ECLB75W-48S15	18-75 VDC	15 VDC	0 mA	5000 mA	8 mA	1736 mA	92	91	5000µF
ECLB75W-48D12	18-75 VDC	±12 VDC	0 mA	±3120 mA	10 mA	1726 mA	91	90.5	3200µF
ECLB75W-48D15	18-75 VDC	±15 VDC	0 mA	±2500 mA	10 mA	1717 mA	91.5	91	2500µF
ECLB75W-48D24	18-75 VDC	±24 VDC	0 mA	±1560 mA	10 mA	1717 mA	91.5	91	1560µF

NOTE:

1. Nominal Input Voltage 24 or 48 VDC
2. Measured at Nominal Input Voltage
3. Measured at 12VDC for 24Vin, 24VDC for 48Vin

4. An external input capacitor 100µF for 48Vin models and 220µF for 24Vin models are recommended to reduce input ripple voltage.

Derating Curve

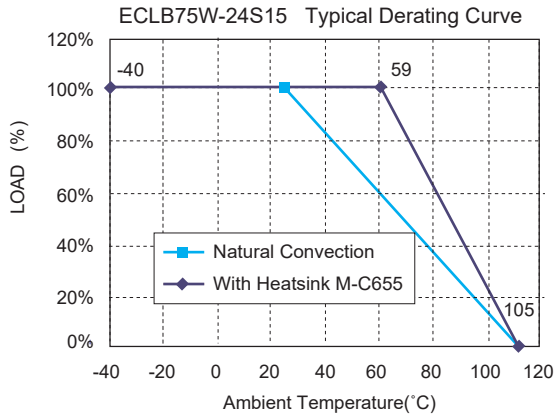

External Output Trim

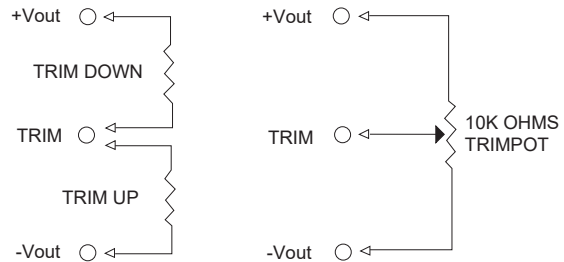

Specifications

All Specifications Typical At Nominal Line, Full Load, and 25°C Unless Otherwise Noted

INPUT SPECIFICATIONS

Input Voltage Range	24VDC.....9 – 36VDC 48VDC.....18 – 75VDC
Input Surge Voltage (100ms max.)	24VDC.....50VDC max. 48VDC.....100VDC max.
Under Voltage Lockout	
24Vin Power Up	8.5VDC typ.
24Vin Power Down	7.8VDC typ.
48Vin Power Up	16VDC typ.
48Vin Power Down	15VDC typ.
Input Filter (note6)	PI Type
Positive Logic Remote On/Off	See note 3 & 4

OUTPUT SPECIFICATIONS

Voltage Accuracy:	±1.0% max.
Voltage Balance (Dual)	±1% max.
Transient Response: 75%~100% Step Load Change	
Error Band	±5% Vout nominal,
Recovery Time	<250us
Ripple & Noise, 20MHz BW (Measured with 1uF MLCC)	+10%, -20%
Vo=5V	100mV pk-pk max.
Vo=12V&15V&±12V&±15V	150mV pk-pk max.
Vo=±24V	240mV pk-pk max.
Temperature Coefficient	±0.02% /°C max.
Line Regulation (note 1)	±0.2% max.
Load Regulation (note 2)	±0.5% max.
	Continuous
Cross Regulation (Dual Output)	±5% max.
Load Cross Variation 10%/100%	
Over Voltage Protection	Zener or TVS Clamp
Current Limit	110% - 160% Nominal Output
Output Short Circuit Protection	Continuous (Hiccup Mode)
External Trim Adj. Range	+10%, -20%
Start up time	30ms typ.

GENERAL SPECIFICATIONS

Efficiency	See Table
Isolation Voltage	
Input/Output	2250VDC min.
Input/Case, Output/Case	1600VDC min.
Isolation Resistance	10 ⁹ ohm min.
Isolation Capacitance	
Input/Output	1500pF typ.
Input/Case, Output/Case	1000pF typ.
Switching Frequency	
Single	270KHz typ.
Dual	330KHz typ.
EMI/RFI	Six-Sided Continuous Shield
Operating Ambient Temperature Range	-40°C to +85°C
De-rating, Above 26°C (note5)	Linearly to Zero power at +105°C
Case Temperature	105°C max.
Cooling	Natural Convection
Storage Temperature Range	-55°C to +125°C
Thermal Shutdown, Case Temp.	110°C typ.
MTBF MIL-HDBK-217F, GB, 25°C, Full Load	Vo=5V TBDKhrs typ. Vo=12V TBD Khrs typ. Vo=15V TBDKhrs typ. Vo=±12V TBDKhrs typ. Vo=±15V TBDKhrs typ. Vo=±24V TBDKhrs typ.
Shock/Vibration	Meet MIL-STD-810F
Dimensions	2.05x1.20x0.40 inches (52.0x30.5x10.2 mm)
Case Material	Aluminum with Non-Conductive Base
Weight	39g

NOTE

1. Measured from high line to low line.
2. Measured from full load to min. load.
3. Logic compatibility ... CMOS or open collector TTL, refer to -Vin.
Module on >3.5VDC to 75VDC or open circuit
Module off 0 to < 1.2VDC
4. Suffix "N" to the model number with negative logic remote on/off
Module on 0 to < 1.2 VDC
Module off >3.5VDC to 75VDC or open circuit
5. Maximum case temperature under any operating condition should not be exceeded 105°C
6. An external input capacitor 100uF for 48Vin models and 220uF for 24Vin models are recommended to reduce input ripple voltage

EC1SC SERIES

20 WATT, 4:1 INPUT RANGE

Features

- ◆ 20W Isolated Output
- ◆ 2" x 1.6" Six-Sided Shield Metal Case
- ◆ Efficiency to 84%
- ◆ 4 : 1 Input Range
- ◆ Pi Input Filter
- ◆ Continuous Short Circuit Protection
- ◆ Meets EN55022 Class A, Conducted
- ◆ Remote On/Off Control
- ◆ CE Mark Meets 2004/108/EC
- ◆ UL60950-1 Approval

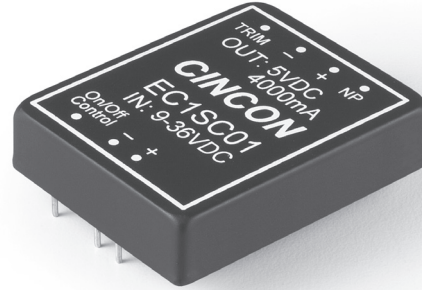

Mechanical Dimensions

All Dimensions in Inches (mm)
 Tolerance Inches: X.XX=±0.04, X.XXX=±0.010
 Millimeters: X.X=±0.5, X.XX=±0.25

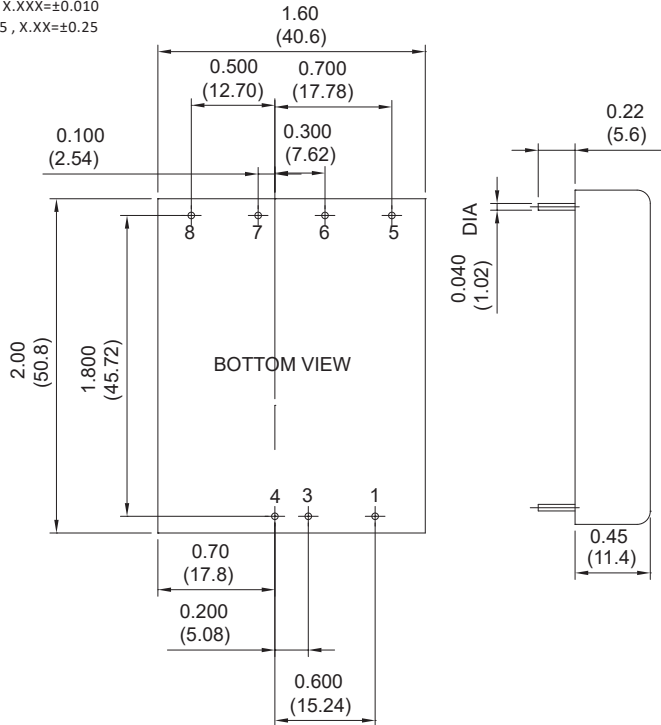

PIN CONNECTION		
PIN	Single Output	Dual Output
1	On/Off Control	On/Off Control
3	-V Input	-V Input
4	+V Input	+V Input
5	Trim	Trim
6	-V Output	-V Output
7	+V Output	Common
8	No Pin	+V Output

MODEL NUMBER	INPUT VOLTAGE	OUTPUT VOLTAGE	OUTPUT CURRENT	INPUT CURRENT		% EFF.	CAPACITOR LOAD MAX.
				NO LOAD	FULL LOAD		
EC1SC01	9-36 VDC	5 VDC	4000 mA	15 mA	1029 mA	81	4000µF
EC1SC02	9-36 VDC	12 VDC	1670 mA	15 mA	1006 mA	83	1670µF
EC1SC03	9-36 VDC	15 VDC	1330 mA	15 mA	1004 mA	83	1330µF
EC1SC04	9-36 VDC	±12 VDC	±833 mA	20 mA	1004 mA	83	833µF
EC1SC05	9-36 VDC	±15 VDC	±666 mA	20 mA	1004 mA	83	666µF
EC1SC06	9-36 VDC	±5 VDC	±2000 mA	20 mA	1004 mA	83	2000µF
EC1SC07	9-36 VDC	3.3 VDC	4000 mA	15 mA	705 mA	78	4000µF
EC1SC11	18-72 VDC	5 VDC	4000 mA	10 mA	508 mA	82	4000µF
EC1SC12	18-72 VDC	12 VDC	1670 mA	10 mA	497 mA	84	1670µF
EC1SC13	18-72 VDC	15 VDC	1330 mA	10 mA	496 mA	84	1330µF
EC1SC14	18-72 VDC	±12 VDC	±833 mA	15 mA	496 mA	84	833µF
EC1SC15	18-72 VDC	±15 VDC	±666 mA	15 mA	496 mA	84	666µF
EC1SC16	18-72 VDC	±5 VDC	±2000 mA	15 mA	496 mA	84	2000µF
EC1SC17	18-72 VDC	3.3 VDC	4000 mA	10 mA	353 mA	78	4000µF

NOTE: 1. Nominal Input Voltage 24 or 48VDC

Derating Curve

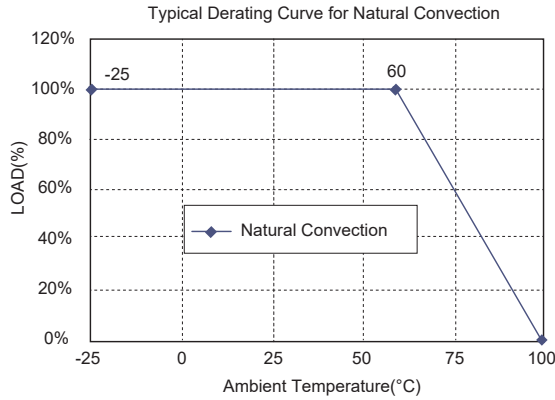

External Output Trim

Output may optionally be externally trimmed ($\pm 10\%$) with a fixed resistor or an external trimpot as shown.

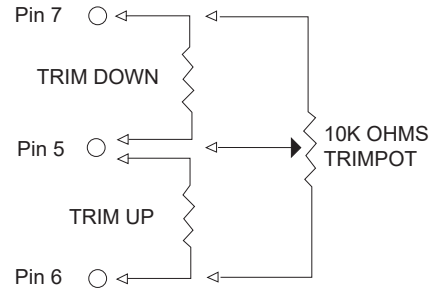

Specification

All Specifications Typical At Nominal Line, Full Load, and 25°C Unless Otherwise Noted

INPUT SPECIFICATIONS

Input Voltage Range	24V 9-36V
	48V 18-72V
Input Surge Voltage (100ms max.)	24V 50Vdc max.
	48V 100Vdc max.
Input Filter	Pi Type
Positive Logic Remote On/Off /Control	See Note3

OUTPUT SPECIFICATIONS

Voltage Accuracy	
Single Output	$\pm 1.0\%$ max.
Dual +Output	$\pm 1.0\%$ max.
Dual -Output	$\pm 2.0\%$ max.
Voltage Balance, Dual Output at Full Load	$\pm 1.0\%$ max.
Transient Response	
Single 25% Step Load Change	< 500 μ s
Dual FL-1/2L $\pm 1\%$ Error Band	< 500 μ s
External Trim Adj, Range	$\pm 10\%$
Ripple & Noise, 20MHz BW	20mV RMS, max. 75mV p-p max.
Temperature Coefficient	$\pm 0.02\%/^{\circ}\text{C}$ max.
Short Circuit Protection	Continuous
Line Regulation (note 1)	$\pm 0.5\%$ max.
Load Regulation (note 2)	$\pm 0.5\%$ max.
Start up time	270ms Typ.

GENERAL SPECIFICATIONS

Efficiency	See Table
Isolation Voltage	1500 VDC min
Isolation Resistance	10 ⁸ ohms
Isolation Capacitance	1000pF Typ.
Switching Frequency	300KHz Typ.
Operating Ambient Temperature Range	-25°C to +71°C
De-rating, Above 60°C	Linearly to Zero power at +100°C
Case Temperature(note 4)	100°C max.
Storage Temperature Range	-55°C to +105°C
Humidity	95% RH max. Non condensing
MTBF MIL-STD-217F, GB, 25°C, Full Load	1500KHrs Typ.
EMI/RFI	Six Sided Continuous Shield
Dimensions	2.00 x 1.60 x 0.45 inches (50.8 x 40.6 x 11.4mm)
Case Material	Black Coated Copper with Non-Conductive Base
Weight	53 g

NOTE

- Measured from high line to low line.
- Measured from full load to 1/4 load.
- Remote on/off control:
 - Logic compatibilityCMOS or open collector TTL
 - EC-On >+5.5VDC to 75VDC or open circuit
 - EC-Off < 1.8VDC
 - Control common.....referenced to input minus
- Maximum case temperature under any operating condition should not be exceeded 100°C.

EC3SCW SERIES

20-30 WATT, 4:1 INPUT RANGE

Features

- ◆ 20-30W Isolated Output
- ◆ 2" x 1.6" Six-Sided Shield Metal Case
- ◆ High Efficiency Up to 91%
- ◆ Fixed 300KHz Switching Frequency
- ◆ 4 : 1 Wide Input Range
- ◆ Regulated Outputs
- ◆ Continuous Short Circuit Protection
- ◆ Industry Standard Pin-Out
- ◆ CE Mark Meets 2004/108/EC
- ◆ Safety Meets UL60950-1, EN60950-1 and IEC60950-1

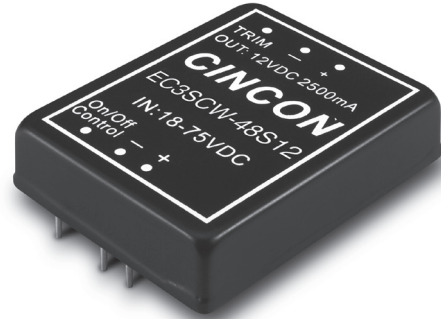

Mechanical Dimensions

NOTE: Pin Size is 0.04±0.004 Inch (1.0±0.1mm)DIA
 All Dimensions in Inches (mm)
 Tolerance Inches: X.XX±0.04 , X.XXX±0.010
 Millimeters: X.X±0.5 , X.XX±0.25

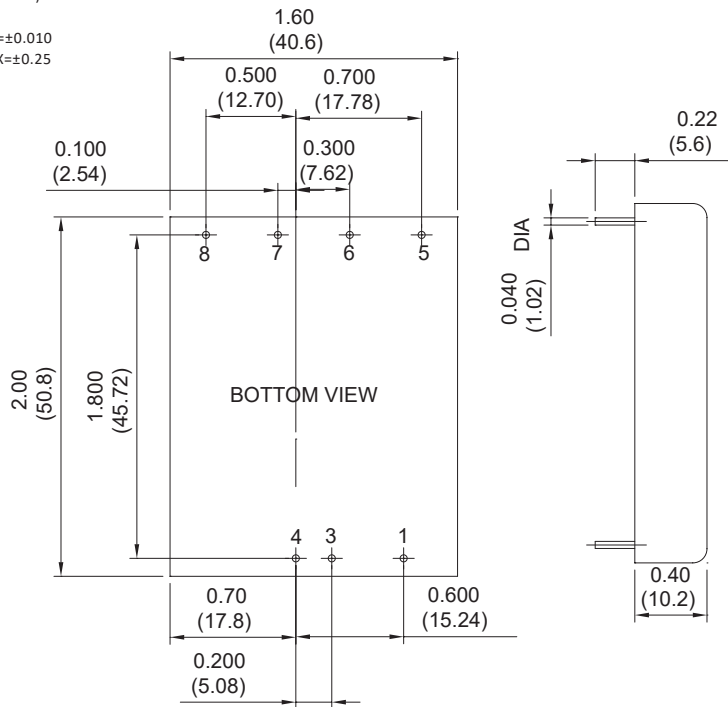

PIN CONNECTION	
PIN	function
1	On/Off Control
3	-V Input
4	+V Input
5	Trim
6	-V Output
7	+V Output
8	No Pin

MODEL NUMBER	INPUT VOLTAGE	OUTPUT VOLTAGE	OUTPUT CURRENT		INPUT CURRENT		% EFF.	CAPACITOR LOAD MAX.
			MIN.	MAX.	NO LOAD	FULL LOAD		
EC3SCW-24S3V3	9-36 VDC	3.3 VDC	0 mA	7500 mA	50 mA	1172 mA	88	7500µF
EC3SCW-24S05	9-36 VDC	5 VDC	0 mA	6000 mA	60 mA	1404 mA	89	6000µF
EC3SCW-24S12	9-36 VDC	12 VDC	0 mA	2500 mA	80 mA	1374 mA	91	2500µF
EC3SCW-24S15	9-36 VDC	15 VDC	0 mA	2000 mA	50 mA	1374 mA	91	2000µF
EC3SCW-48S3V3	18-75 VDC	3.3 VDC	0 mA	7500 mA	30 mA	586 mA	88	7500µF
EC3SCW-48S05	18-75 VDC	5 VDC	0 mA	6000 mA	30 mA	694 mA	90	6000µF
EC3SCW-48S12	18-75 VDC	12 VDC	0 mA	2500 mA	40 mA	687 mA	91	2500µF
EC3SCW-48S15	18-75 VDC	15 VDC	0 mA	2000 mA	50 mA	687 mA	91	2000µF

NOTE: 1. Nominal Input Voltage 24, 48VDC

Derating Curve

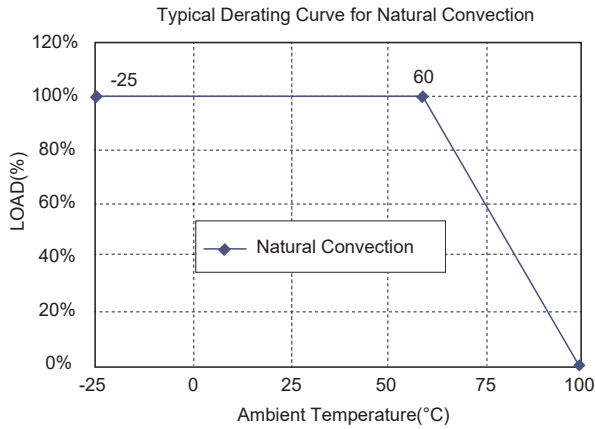

External Output Trim

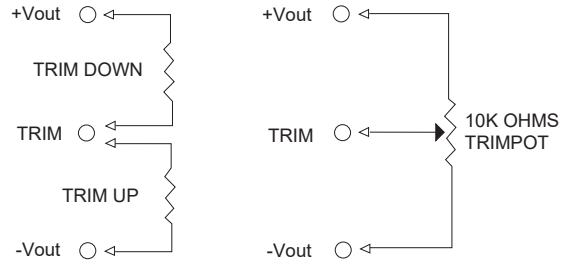

Specification

All Specifications Typical At Nominal Line, Full Load, and 25°C Unless Otherwise Noted

INPUT SPECIFICATIONS

Input Voltage Range	24V	9-36V	
	48V	18-75V	
Input Surge Voltage (100ms max.)	24V	50Vdc max.	
	48V	100Vdc max.	
Under Voltage Lockout	24Vin	power up	8.8V typ.
		power down	8.0V typ.
	48Vin	power up	17V typ.
		power down	16V typ.
Positive Logic Remote On/Off (note 3 & 4)			
Input Filter	Pi Type		

OUTPUT SPECIFICATIONS

Voltage Accuracy:	±1.5% max.
Transient Response: 75% - 100% Step Load Change	
Error Band	±5% Vout nominal
Recovery Time	< 300µs
External Adjustment Range, %Vo	±10%
Ripple & Noise, 20MHz BW (Measured with 0.1µF MLCC)	
3.3V & 5V	20mV RMS max. 75mV pk-pk max.
12V & 15V	20mV RMS max. 100mV pk-pk max.
Temperature Coefficient	±0.02%/°C
Line Regulation (note 1)	±0.5% max.
Load Regulation (note 2)	±0.5% max.
Output Over voltage Protection (Zener or TVS Clamp)	
3.3V	3.9V
5V	6.2V
12V	15V
15V	18V
Output Current Limit, % Nominal Output	110%-150%
Output Short Circuit Protection	Continuous (Hiccup Mode)
Start up time	8ms typ.

GENERAL SPECIFICATIONS

Efficiency	See Table
Isolation Voltage	Input/Output1500VDC min. 10 ⁸ ohm min.
Isolation Resistance	
Isolation Capacitance	1000pF typ.
Switching Frequency	24Vin 300KHz typ.
	48Vin 250KHz typ.
Operating Ambient Temperature	-40°C to +85°C
De-rating, Above 60°C	Linearly to Zero power at 100°C
Case Temperature (note 5)	100°C max.
Cooling	Natural Convection
Storage Temperature	-55°C to +125°C
Humidity	95% RH max. Non condensing
MTBF MIL-STD-217F, GB, 25°C, Full Load	650Khrs typ.
Thermal Shutdown Case Temp.	110°C typ.
Dimensions	2.00 × 1.60 × 0.40 inches (50.8 × 40.6 × 10.2 mm)
Case Material	Black Coated Copper with Non-Conductive Base
Weight	50 g

NOTE

- Measured from high line to low line.
- Measured from full load to 10% load.
- Logic compatibility CMOS or open collector TTL, ref. to -Vin
Module On >3.5VDC to 75VDC or open circuit
Module Off < 1.2VDC
- Suffix "N" to the model number with negative logic remote on/off
Module On < 1.2VDC
Module Off >3.5VDC to 75VDC or open circuit
- Maximum case temperature under any operating condition should not be exceeded 100°C.

EC3C SERIES

15 WATT, 2:1 INPUT RANGE

Features

- ◆ 15W Isolated Output
- ◆ Efficiency to 82%
- ◆ 2" x 2" Six-Sided Shield Metal Case
- ◆ Alternative Pin Configuration
- ◆ Fixed 200KHz Switching Frequency

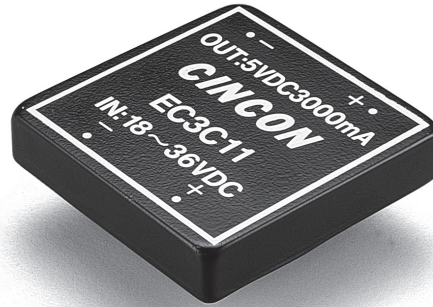

Not Recommended For New Design

Mechanical Dimensions

All Dimensions in Inches (mm)
 Tolerance Inches: X.XX±0.04, X.XXX±0.010
 Millimeters: X.X±0.5, X.XX±0.25

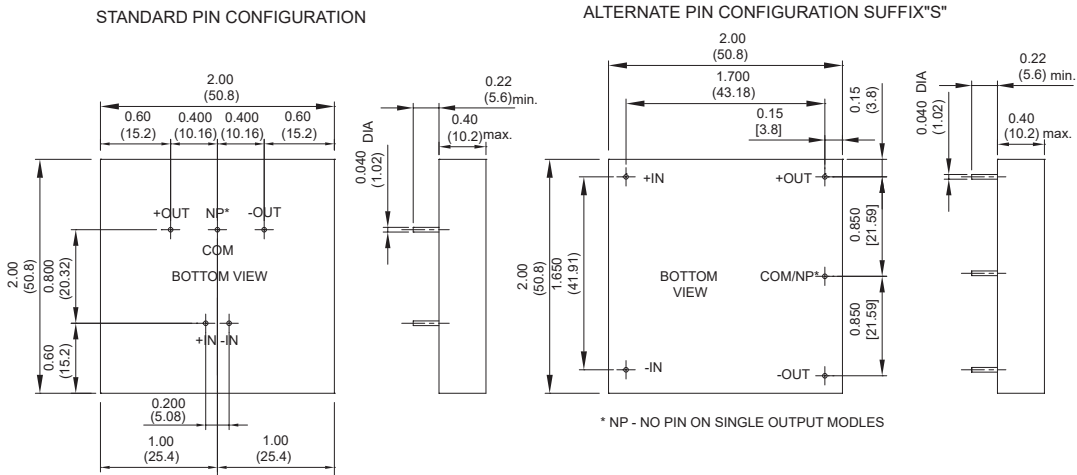

MODEL NUMBER	INPUT VOLTAGE	OUTPUT VOLTAGE	OUTPUT CURRENT	INPUT CURRENT		% EFF.
				NO LOAD	FULL LOAD	
EC3C01	9-18 VDC	5 VDC	3000 mA	30 mA	1660 mA	75
EC3C02	9-18 VDC	12 VDC	1250 mA	30 mA	1625 mA	78
EC3C03	9-18 VDC	15 VDC	1000 mA	30 mA	1625 mA	78
EC3C04	9-18 VDC	±12 VDC	±625 mA	35 mA	1620 mA	77
EC3C05	9-18 VDC	±15 VDC	±500 mA	35 mA	1620 mA	77
EC3C06	9-18 VDC	±5 VDC	±1500 mA	35 mA	1620 mA	77
EC3C07	9-18 VDC	3.3 VDC	3000 mA	30 mA	1178 mA	70
EC3C11	18-36 VDC	5 VDC	3000 mA	15 mA	812 mA	78
EC3C12	18-36 VDC	12 VDC	1250 mA	20 mA	772 mA	81
EC3C13	18-36 VDC	15 VDC	1000 mA	20 mA	772 mA	81
EC3C14	18-36 VDC	±12 VDC	±625 mA	25 mA	780 mA	80
EC3C15	18-36 VDC	±15 VDC	±500 mA	25 mA	780 mA	80
EC3C16	18-36 VDC	±5 VDC	±1500 mA	25 mA	780 mA	80
EC3C17	18-36 VDC	3.3 VDC	3000 mA	15 mA	557 mA	74
EC3C21	36-72 VDC	5 VDC	3000 mA	10 mA	390 mA	80
EC3C22	36-72 VDC	12 VDC	1250 mA	15 mA	381 mA	82
EC3C23	36-72 VDC	15 VDC	1000 mA	15 mA	381 mA	82
EC3C24	36-72 VDC	±12 VDC	±625 mA	20 mA	386 mA	81
EC3C25	36-72 VDC	±15 VDC	±500 mA	20 mA	386 mA	81
EC3C26	36-72 VDC	±5 VDC	±1500 mA	20 mA	386 mA	81
EC3C27	36-72 VDC	3.3 VDC	3000 mA	20 mA	271 mA	76

Derating Curve

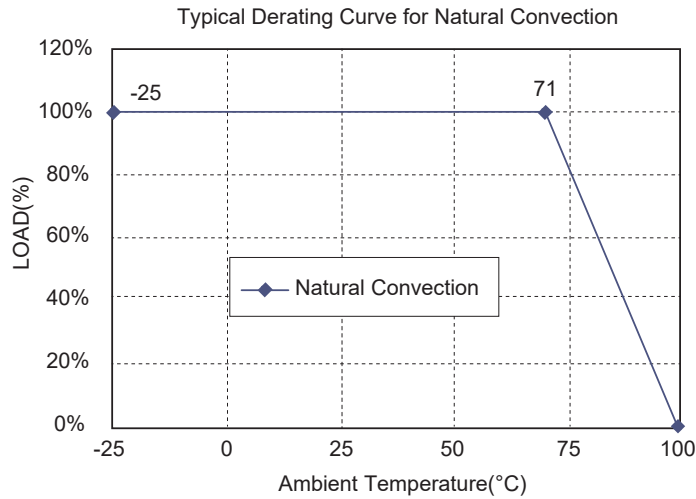

Specification

All Specifications Typical At Nominal Line, Full Load, and 25°C Unless Otherwise Noted

INPUT SPECIFICATIONS

Input Voltage Range	12V 9-18V
	24V 18-36V
	48V 36-72V
Input Filter	Pi Type

OUTPUT SPECIFICATIONS

Voltage Accuracy	
Single Output	±1.0% max.
Dual +Output	±1.0% max.
Dual - Output	±3.0% max.
Voltage Balance Dual Output Full Load	±1.0% max.
Transient Response	
Single 25% Step Load Change	< 500µs
Dual FL-1/2L±1% Error Band	< 500µs
Ripple and Noise, 20MHz BW	10mV RMS. max. 75mV p-p max.
Temperature Coefficient	±0.02%/°C
Short Circuit Protection	Indefinite & Current Limit
Line Regulation (note 1), Single/Dual Output	±0.2% max.
Load Regulation (note 2), Single/Dual Output	±1.0% max.

GENERAL SPECIFICATIONS

Efficiency	See Table
Isolation Voltage	500 VDC min.
Isolation Resistance	10 ⁹ ohms
Switching Frequency	200KHz, typ.
Operating Ambient Temperature Range	-25°C to +71°C
De-rating, Above 71°C	Linearly to Zero power at 100°C
Case Temperature (note 5)	100°C max.
Cooling	Natural Convection
Storage Temperature Range	-40°C to +100°C
EMI/RFI	Six-Sided Continuous Shield
Dimensions	2.00 × 2.00 × 0.40 inches (50.8 × 50.8 × 10.2mm)
Case Material	Black Coated Copper With Non-Conductive Base
Weight	57 g

NOTE

1. Measured from high line to low line.
2. Measured from full load to 1/4 full load.
3. Determine the correct fuse size by calculating the maximum DC current drain at low line input, maximum load and then adding 20 to 25% to get desired fuse size.
4. Alternative pin configuration suffix "S"
5. Maximum case temperature under any operating condition should not be exceeded 100°C.

EC5C SERIES

15 WATT, 4:1 INPUT RANGE

Features

- ◆ 15W Isolated Output
- ◆ 2" x 2" Six-Sided Shield Metal Case
- ◆ 4 : 1 Input Range
- ◆ Efficiency to 84%
- ◆ Remote On/Off Control
- ◆ Regulated Outputs
- ◆ Continuous Short Circuit Protection
- ◆ CE Mark Meets 2004/108/EC
- ◆ UL60950-1 Approval

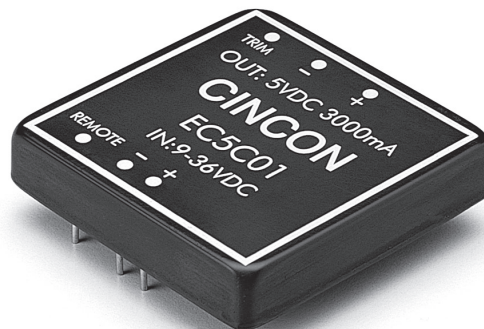

Mechanical Dimensions

All Dimensions in Inches (mm)
 Tolerance Inches: X.XX=±0.04, X.XXX=±0.010
 Millimeters: X.X=±0.5, X.XX=±0.25

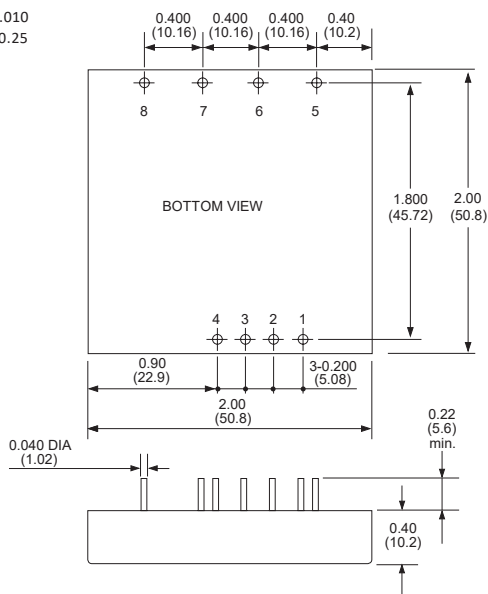

PIN CONNECTION			
PIN	Single	Dual	Triple
1	Remote On/Off Control		
2	No Pin	No Pin	No Pin
3	-V Input	-V Input	-V Input
4	+V Input	+V Input	+V Input
5	Trim	Trim	-Aux. Output
6	-V Output	-V Output	Common
7	+V Output	Common	+5V Output
8	No Pin	+V Output	+Aux. Output

MODEL NUMBER	INPUT VOLTAGE	OUTPUT VOLTAGE	OUTPUT CURRENT		INPUT CURRENT		% EFF.
			MIN.	MAX.	NO LOAD	FULL LOAD	
EC5C01	9-36 VDC	5 VDC	0 mA	3000 mA	15 mA	770 mA	81
EC5C02	9-36 VDC	12 VDC	0 mA	1250 mA	15 mA	745 mA	84
EC5C03	9-36 VDC	15 VDC	0 mA	1000 mA	15 mA	760 mA	82
EC5C04	9-36 VDC	±5 VDC	±0 mA	±1500 mA	20 mA	770 mA	81
EC5C05	9-36 VDC	±12 VDC	±0 mA	±625 mA	20 mA	760 mA	82
EC5C06	9-36 VDC	±15 VDC	±0 mA	±500 mA	20 mA	750 mA	83
EC5C07	9-36 VDC	5/±12 VDC	250/±100 mA	1500/±310 mA	20 mA	780 mA	80
EC5C08	9-36 VDC	5/±15 VDC	250/±100 mA	1500/±250 mA	20 mA	780 mA	80
EC5C09	9-36 VDC	3.3 VDC	0 mA	3000 mA	15 mA	530 mA	78
EC5C11	18-72 VDC	5 VDC	0 mA	3000 mA	10 mA	385 mA	81
EC5C12	18-72 VDC	12 VDC	0 mA	1250 mA	10 mA	375 mA	83
EC5C13	18-72 VDC	15 VDC	0 mA	1000 mA	10 mA	380 mA	82
EC5C14	18-72 VDC	±5 VDC	±0 mA	±1500 mA	15 mA	385 mA	81
EC5C15	18-72 VDC	±12 VDC	±0 mA	±625 mA	15 mA	375 mA	83
EC5C16	18-72 VDC	±15 VDC	±0 mA	±500 mA	15 mA	385 mA	81
EC5C17	18-72 VDC	5/±12 VDC	250/±100 mA	1500/±310 mA	15 mA	385 mA	81
EC5C18	18-72 VDC	5/±15 VDC	250/±100 mA	1500/±250 mA	15 mA	390 mA	80
EC5C19	18-72 VDC	3.3 VDC	0 mA	3000 mA	10 mA	270 mA	77

NOTE: 1. Nominal Input Voltage 24 or 48VDC

Derating Curve

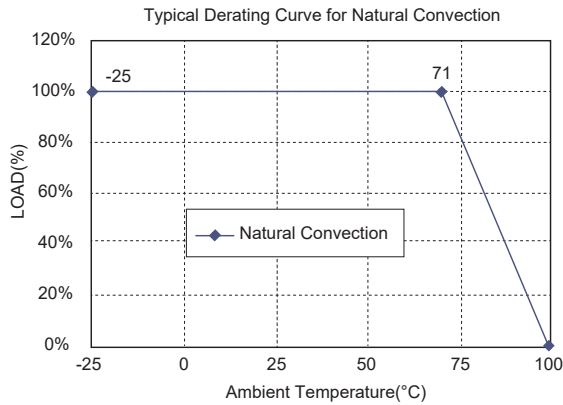

External Output Trim

Output may optionally be externally trimmed ($\pm 10\%$) with a fixed resistor or an external trimpot as shown.

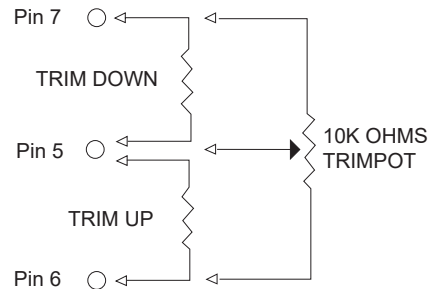

Specification

All Specifications Typical At Nominal Line, Full Load, and 25°C Unless Otherwise Noted

INPUT SPECIFICATIONS

Input Voltage Range	24V.....9-36V
	48V.....18-72V
Input Surge Voltage (100ms max.)	24V.....50Vdc max.
	48V.....100Vdc max.
Input Filter	Pi Type

OUTPUT SPECIFICATIONS

Voltage Accuracy	
Single Output, Dual +Output	$\pm 1.0\%$ max.
Dual-Output	$\pm 3.0\%$ max.
Triple, 5V	$\pm 2.0\%$ max.
12V/15V	$\pm 3.0\%$ max.
Voltage Balance (Dual)	$\pm 1.0\%$ max.
Transient Response	
Single 25% Step Load Change	< 500 μ s
Dual FL-1/2L $\pm 1\%$ Error Band	< 500 μ s
External Trim Adj. Range	$\pm 10\%$
Ripple & Noise, 20MHz BW	10mV RMS max., 75mV pk-pk max.
Temperature Coefficient	$\pm 0.02\%/^{\circ}\text{C}$
Short Circuit Protection	Continuous
Line Regulation Single/Dual (note 1)	$\pm 0.2\%$ max.
Triple	$\pm 1.0\%$ max.
Load Regulation Single/Dual (note 2)	$\pm 1.0\%$ max.
Triple	$\pm 5.0\%$ max.
Start up time	300ms typ.

GENERAL SPECIFICATIONS

Efficiency	See Table
Isolation Voltage	500 VDC min.
Isolation Resistance	10 ⁹ ohm min.
Isolation Capacitance	1000pF typ.
Switching Frequency	300KHz typ.
Case Grounding	Connected to Output Common
Operating Ambient Temperature Range	-25°C to +71°C
De-rating, Above 71°C	Linearly to Zero power at 100°C
Case Temperature (note 3)	100°C max.
Cooling	Natural Convection
Storage Temperature Range	-55°C to +105°C
Humidity	95% RH max. Non condensing
MTBF MIL-STD-217F, GB, 25°C, Full Load	1300Khrs typ.
EMI/RFI	Six-Sided Continuous Shield
Dimensions	2.00 x 2.00 x 0.40 inches (50.8 x 50.8 x 10.2mm)
Case Material	Black Coated Copper With Non-Conductive Base
Weight	59 g

NOTE

1. Measured from high line to low line.
2. Measured from full load to 1/4 full load.
3. Maximum case temperature under any operating condition should not be exceeded 100°C.

TRIPLE OUTPUT LOADING TABLE (1)			
Output (Pin No.)	Voltage	Amperes	
		Min. (2)	Nom.
7	+5	0.25	1.5
8 & 5	+12 & -12	0.10	0.31
8 & 5	+15 & -15	0.10	0.25

Remote On/Off Control	
Logic Compatibility	CMOS or Open Collector TTL
Ec-On	>+5.5 VDC to 75Vdc or Open Circuit
Ec-Off	<1.8 VDC
Shutdown Idle Current	10mA
Control Common	Referenced to Input Minus

- NOTE:
1. Maximum total power from all outputs is limited to 15 watts but no output should be allowed to exceed its maximum current
 2. Minimum current on each output is required to maintain specified

EC6C SERIES

25-30 WATT, 2:1 INPUT RANGE

Features

- ◆ 25-30W Isolated Output
- ◆ 2" x 2" Six-Sided Shield Metal Case
- ◆ 2 : 1 Input Range
- ◆ Regulated Outputs
- ◆ Efficiency to 88%
- ◆ Remote ON/OFF Control
- ◆ CE Mark Meets 2004/108/EC
- ◆ UL60950-1 Approval

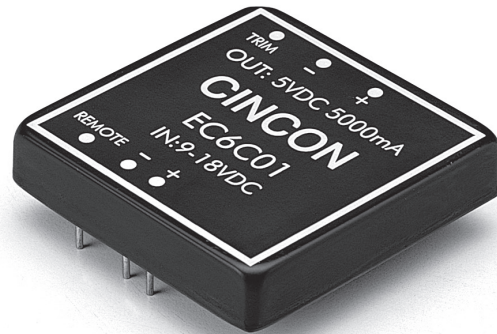

Mechanical Dimensions

All Dimensions in Inches (mm)
 Tolerance Inches: X.XX=±0.04, X.XXX=±0.010
 Millimeters: X.X=±1.0, X.XX=±0.25

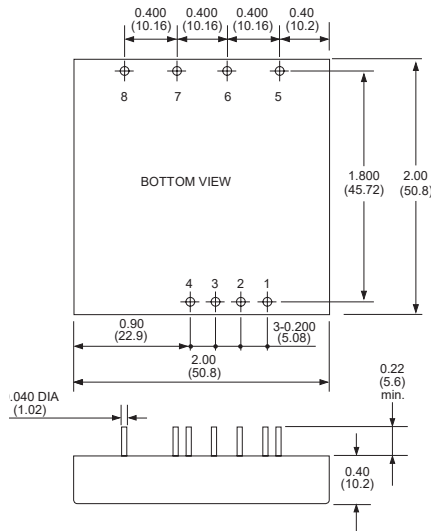

PIN CONNECTION			
PIN	Single Output	Dual Output	Triple
1	Remote On/Off Control		
2	No Pin	No Pin	No Pin
3	-V Input	-V Input	-V Input
4	+V Input	+V Input	+V Input
5	Trim	Trim	-Aux. Output
6	-V Output	-V Output	Common
7	+V Output	Common	+5V Output
8	No Pin	+V Output	+Aux. Output

MODEL NUMBER	INPUT VOLTAGE	OUTPUT VOLTAGE	OUTPUT CURRENT		INPUT CURRENT		% EFF.	CAPACITOR LOAD MAX.
			MIN.	MAX.	NO LOAD	FULL LOAD		
EC6C01	9-18 VDC	5 VDC	0 mA	5000 mA	30 mA	2675 mA	84	5000 uF
EC6C02	9-18 VDC	12 VDC	0 mA	2500 mA	30 mA	3050 mA	88	2500 uF
EC6C03	9-18 VDC	15 VDC	0 mA	2000 mA	30 mA	3050 mA	88	2000 uF
EC6C04	9-18 VDC	±5 VDC	±0 mA	±2500 mA	35 mA	2675 mA	83	2500 uF
EC6C05	9-18 VDC	±12 VDC	±0 mA	±1250 mA	35 mA	3050 mA	88	1250 uF
EC6C06	9-18 VDC	±15 VDC	±0 mA	±1000 mA	35 mA	3050 mA	87	1000 uF
EC6C07	9-18 VDC	5/±12 VDC	500/±100 mA	3500/±310 mA	35 mA	2640 mA	81	3500/310 uF
EC6C08	9-18 VDC	5/±15 VDC	500/±100 mA	3500/±250 mA	35 mA	2640 mA	82	3500/250 uF
EC6C09	9-18 VDC	3.3 VDC	0 mA	5000 mA	30 mA	1860 mA	80	5000 uF
EC6C11	18-36 VDC	5 VDC	0 mA	5000 mA	30 mA	1336 mA	83	5000 uF
EC6C12	18-36 VDC	12 VDC	0 mA	2500 mA	30 mA	1525 mA	87	2500 uF
EC6C13	18-36 VDC	15 VDC	0 mA	2000 mA	30 mA	1525 mA	87	2000 uF
EC6C14	18-36 VDC	±5 VDC	±0 mA	±2500 mA	30 mA	1336 mA	82	2500 uF
EC6C15	18-36 VDC	±12 VDC	±0 mA	±1250 mA	30 mA	1470 mA	87	1250 uF
EC6C16	18-36 VDC	±15 VDC	±0 mA	±1000 mA	30 mA	1470 mA	86	1000 uF
EC6C17	18-36 VDC	5/±12 VDC	500/±100 mA	3500/±310 mA	30 mA	1320 mA	82	3500/310 uF
EC6C18	18-36 VDC	5/±15 VDC	500/±100 mA	3500/±250 mA	30 mA	1320 mA	82	3500/250 uF
EC6C19	18-36 VDC	3.3 VDC	0 mA	5000 mA	30 mA	920 mA	79	5000 uF
EC6C21	36-72 VDC	5 VDC	0 mA	5000 mA	20 mA	660 mA	83	5000 uF
EC6C22	36-72 VDC	12 VDC	0 mA	2500 mA	20 mA	765 mA	87	2500 uF
EC6C23	36-72 VDC	15 VDC	0 mA	2000 mA	20 mA	765 mA	87	2000 uF
EC6C24	36-72 VDC	±5 VDC	±0 mA	±2500 mA	25 mA	660 mA	82	2500 uF
EC6C25	36-72 VDC	±12 VDC	±0 mA	±1250 mA	25 mA	735 mA	87	1250 uF
EC6C26	36-72 VDC	±15 VDC	±0 mA	±1000 mA	25 mA	735 mA	87	470 uF
EC6C27	36-72 VDC	5/±12 VDC	500/±100 mA	3500/±310 mA	25 mA	655 mA	83	2200/220 uF
EC6C28	36-72 VDC	5/±15 VDC	500/±100 mA	3500/±250 mA	25 mA	655 mA	82	1500/150 uF
EC6C29	36-72 VDC	3.3 VDC	0 mA	5000 mA	20 mA	460 mA	79	5000 uF

NOTE: 1. Nominal Input Voltage 12, 24 or 48VDC

Derating Curve

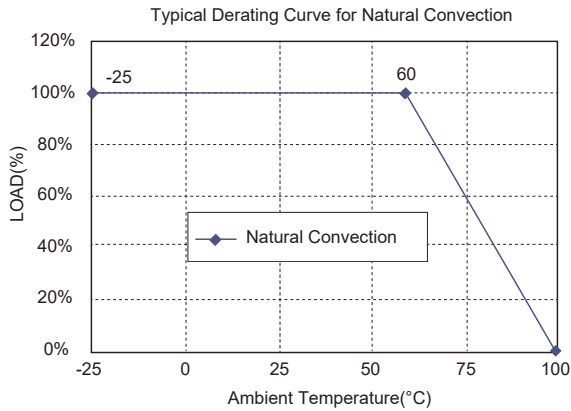

External Output Trim

Output may optionally be externally trimmed ($\pm 10\%$) with a fixed resistor or an external trimpot as shown.

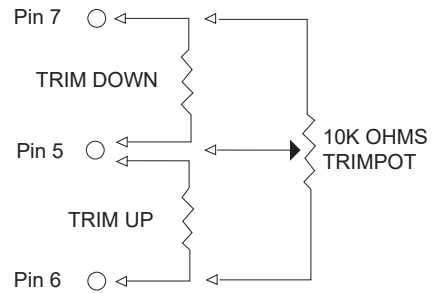

Specification

All Specifications Typical At Nominal Line, Full Load, and 25°C Unless Otherwise Noted

INPUT SPECIFICATIONS

Input Voltage Range	12V 9-18V
	24V 18-36V
	48V 36-72V
Input Surge Voltage (100ms max.)	12V 25Vdc max.
	24V 50Vdc max.
	48V 100Vdc max.
Input Filter	Pi Type

OUTPUT SPECIFICATIONS

Voltage Accuracy	
Single Output	$\pm 2.0\%$ max.
Dual +Output	$\pm 2.0\%$ max.
Dual - Output	$\pm 3.0\%$ max.
Triple, 5V	$\pm 2.0\%$ max.
12V/15V	$\pm 5.0\%$ max.
Voltage Balance (Dual)	$\pm 1.0\%$ max.
Transient Response.	
Single 25% Step Load Change	< 500 μ s
Dual FL-1/2L $\pm 1\%$ Error Band	< 500 μ s
External Trim Adj. Range	$\pm 10\%$
Ripple and Noise, 20MHz BW	10mV RMS. max.
	75mV p-p max.
Temperature Coefficient	$\pm 0.02\%/^{\circ}\text{C}$
Short Circuit Protection	Continuous
Line Regulation Single/Dual (note 1)	$\pm 0.5\%$ max.
Triple	$\pm 1.0\%$ max.
Load Regulation Single/Dual (note 2)	$\pm 1.0\%$ max.
Triple	$\pm 5.0\%$ max.
Start up time	900ms typ.

GENERAL SPECIFICATIONS

Efficiency	See Table
Isolation Voltage	500 VDC min.
Isolation Resistance	10^9 ohms
Isolation Capacitance	500pF typ.
Switching Frequency	300KHz typ.
Case Grounding	Connected to Output Common
Operating Ambient Temperature Range	-25°C to +71°C
De-rating, Above 60°C	Linearly to Zero power at 100°C
Case Temperature (note 3)	100°C max.
Cooling	Natural Convection
Storage Temperature Range	-55°C to +105°C
Humidity	95% RH max. Non condensing
MTBF MIL-STD-217F, GB, 25°C, Full Load	900Khrs typ.
EMI/RFI	Six-Sided Continuous Shield
Dimensions	2.00 x 2.00 x 0.40 inches (50.8 x 50.8 x 10.2mm)
Case Material	Black Coated Copper With Non-Conductive Base
Weight	65 g

NOTE

1. Measured from high line to low line.
2. Measured from full load to 1/4 full load.
3. Maximum case temperature under any operating condition should not be exceeded 100°C.

TRIPLE OUTPUT LOADING TABLE (1)			
Output (Pin No.)	Voltage	Amperes	
		Min. (2)	Nom.
7	+5	0.50	3.5
8 & 5	+12 & -12	0.10	0.31
8 & 5	+15 & -15	0.10	0.25

Remote On/Off Control	
Logic Compatibility	CMOS or Open Collector TTL
Ec-On	>+5.5 VDC or Open Circuit
Ec-Off	<1.8 VDC
Shutdown Idle Current	10mA
Control Common	Referenced to Input Minus

NOTE:
1. Maximum total power from all outputs is limited to 25 watts but no output should be allowed to exceed its maximum current
2. Minimum current on each output is required to maintain specified regulation

EC7C SERIES

40 WATT, 2:1 INPUT RANGE

Features

- ◆ 40W Isolated Output
- ◆ 2" x 2" Six-Sided Shield Metal Case
- ◆ High Efficiency Up to 93%
- ◆ Fixed 350KHz Switching Frequency
- ◆ 2 : 1 Input Range
- ◆ Regulated Outputs
- ◆ Continuous Short Circuit Protection (Except EC7C-XXD3305)
- ◆ UL60950-1 Approval



Mechanical Dimensions

NOTE: Pin Size is 0.02±0.002 Inch(0.5±0.05mm)DIA
 All Dimensions in Inches (mm)
 Tolerance Inches: X.XX±0.04 , X.XXX±0.010
 Millimeters: X.X±0.5 , X.XX±0.25

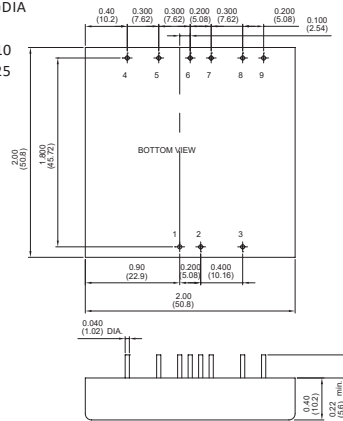

PIN CONNECTION				
PIN	Single	Dual	Dual Positive	Triple
1	+V Input	+V Input	+V Input	+V Input
2	-V Input	-V Input	-V Input	-V Input
3	On / Off	On / Off	On / Off	On / Off
4	NC	No Pin	+3.3Vout	+Aux. Out
5	- Sense	+V Output	Com(3.3V RTM)	Common
6	+Sense	Common	Trim	- Aux. Out
7	+V Output	Common	NC	+V Output
8	-V Output	-V Output	+5V Output	-V Output(Common)
9	Trim	Trim	Com(5V RTN)	NC

*NC : NO CONNECTION WITH PIN

MODEL NUMBER	INPUT VOLTAGE	OUTPUT VOLTAGE	OUTPUT CURRENT		INPUT CURRENT		% EFF.	CAPACITOR LOAD MAX.
			MIN.	MAX.	NO LOAD	FULL LOAD		
EC7C-12S25	9-18 VDC	2.5 VDC	0 mA	10000 mA	200 mA	2354 mA	88.5	10000µF
EC7C-12S33	9-18 VDC	3.3 VDC	0 mA	10000 mA	200 mA	3090 mA	89	10000µF
EC7C-12S05	9-18 VDC	5 VDC	0 mA	8000 mA	200 mA	3683 mA	90.5	8000µF
EC7C-12S12	9-18 VDC	12 VDC	0 mA	3333 mA	200 mA	3643 mA	91.5	3300µF
EC7C-12S15	9-18 VDC	15 VDC	0 mA	2666 mA	200 mA	3642 mA	91.5	2700µF
EC7C-12D12	9-18 VDC	±12 VDC	90 mA	±1800 mA	100 mA	4022 mA	89.5	1800µF
EC7C-12D15	9-18 VDC	±15 VDC	70 mA	±1400 mA	100 mA	3867 mA	90.5	1400µF
EC7C-12D3305	9-18 VDC	3.3/5.0 VDC	0 mA	10A/7.5 A	100 mA	3727 mA	89 ⁽³⁾	7270µF/7270µF
EC7C-12T3312	9-18 VDC	3.3/±12 VDC	0.6A/±40 mA	6A/±0.4 A	200 mA	2768 mA	88.5	6000µF/400µF
EC7C-12T3315	9-18 VDC	3.3/±15 VDC	0.6A/±30 mA	6A/±0.3 A	200 mA	2712 mA	88.5	6000µF/330µF
EC7C-12T0512	9-18 VDC	5.0/±12 VDC	0.6A/±40 mA	6A/±0.4 A	200 mA	3729 mA	88.5	6000µF/400µF
EC7C-12T0515	9-18 VDC	5.0/±15 VDC	0.6A/±30 mA	6A/±0.3 A	200 mA	3611 mA	90	6000µF/330µF
EC7C-24S25	18-36 VDC	2.5 VDC	0 mA	10000 mA	100 mA	1157 mA	90	10000µF
EC7C-24S33	18-36 VDC	3.3 VDC	0 mA	10000 mA	100 mA	1519 mA	90.5	10000µF
EC7C-24S05	18-36 VDC	5 VDC	0 mA	8000 mA	110 mA	1812 mA	92	8000µF
EC7C-24S12	18-36 VDC	12 VDC	0 mA	3333 mA	100 mA	1792 mA	93	3300µF
EC7C-24S15	18-36 VDC	15 VDC	0 mA	2666 mA	100 mA	1792 mA	93	2700µF
EC7C-24D12	18-36 VDC	±12 VDC	90 mA	±1800 mA	100 mA	1967 mA	91.5	1800µF
EC7C-24D15	18-36 VDC	±15 VDC	70 mA	±1400 mA	100 mA	1902 mA	92	1400µF
EC7C-24D3305	18-36 VDC	3.3/5.0 VDC	0 mA	10A/7.5 A	50 mA	1843 mA	90 ⁽²⁾	7270µF/7270µF
EC7C-24T3312	18-36 VDC	3.3/±12 VDC	0.6A/±40 mA	6A/±0.4 A	100 mA	1361 mA	90	6000µF/400µF
EC7C-24T3315	18-36 VDC	3.3/±15 VDC	0.6A/±30 mA	6A/±0.3 A	100 mA	1333 mA	90	6000µF/330µF
EC7C-24T0512	18-36 VDC	5.0/±12 VDC	0.6A/±40 mA	6A/±0.4 A	100 mA	1813 mA	91	6000µF/400µF
EC7C-24T0515	18-36 VDC	5.0/±15 VDC	0.6A/±30 mA	6A/±0.3 A	100 mA	1786 mA	91	6000µF/330µF
EC7C-48S25	36-75 VDC	2.5 VDC	0 mA	10000 mA	50 mA	585 mA	89	10000µF
EC7C-48S33	36-75 VDC	3.3 VDC	0 mA	10000 mA	50 mA	764 mA	90	10000µF
EC7C-48S05	36-75 VDC	5 VDC	0 mA	8000 mA	60 mA	906 mA	92	8000µF
EC7C-48S12	36-75 VDC	12 VDC	0 mA	3333 mA	60 mA	896 mA	93	3300µF
EC7C-48S15	36-75 VDC	15 VDC	0 mA	2666 mA	60 mA	906 mA	92	2700µF
EC7C-48D12	36-75 VDC	±12 VDC	90 mA	±1800 mA	50 mA	989 mA	91	1800µF
EC7C-48D15	36-75 VDC	±15 VDC	70 mA	±1400 mA	50 mA	962 mA	91	1400µF
EC7C-48D3305	36-75 VDC	3.3/5.0 VDC	0 mA	10A/7.5 A	50 mA	926 mA	89.5 ⁽³⁾	7270µF/7270µF
EC7C-48T3312	36-75 VDC	3.3/±12 VDC	0.6A/±40 mA	6A/±0.4 A	50 mA	684 mA	89.5	6000µF/400µF
EC7C-48T3315	36-75 VDC	3.3/±15 VDC	0.6A/±30 mA	6A/±0.3 A	50 mA	682 mA	88	6000µF/330µF
EC7C-48T0512	36-75 VDC	5.0/±12 VDC	0.6A/±40 mA	6A/±0.4 A	50 mA	932 mA	88.5	6000µF/400µF
EC7C-48T0515	36-75 VDC	5.0/±15 VDC	0.6A/±30 mA	6A/±0.3 A	50 mA	903 mA	90	6000µF/330µF

Derating Curve

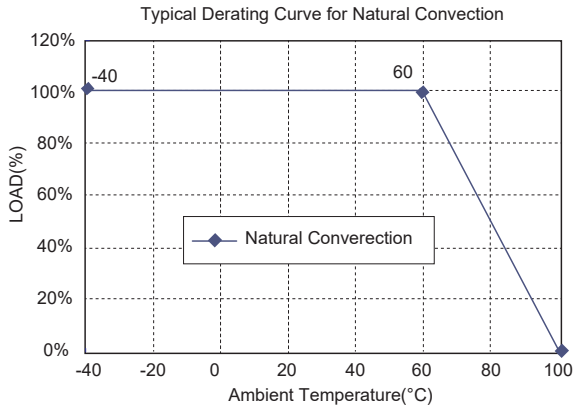

External Output Trim

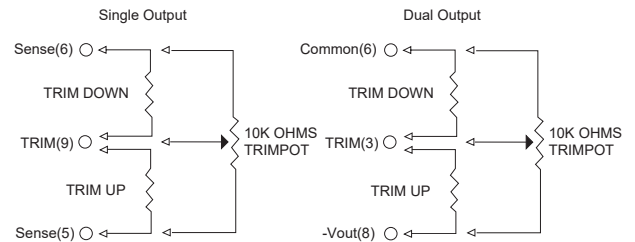

Specification

All Specifications Typical At Nominal Line, Full Load, and 25°C Unless Otherwise Noted

INPUT SPECIFICAT

Input Voltage Range	12V 9-18V 24V 18-36V 48V 36-75V
Input Surge Voltage (100ms max.)	12V 25Vdc max 24V 50Vdc max. 48V 100Vdc max.
Under voltage lockout	12V in power up 8.8V power down 8.0V 24V in power up 17V power down 16V 48V in power up 34V power down 32V
Positive/Negative Logic Remote On/Off (note 5 & 6)	
Input Filter	PI Type

GENERAL SPECIFICATIONS

Efficiency	See Table
Isolation Voltage	Input/Output..1500VDC max.
Isolation Resistance	10 ⁹ ohm min.
Isolation Capacitance	1000pF typ.
Switching Frequency	350KHz typ.
Operating Ambient Temperature	-40°C to +85°C
De-rating, Above 60°C	Linearly to Zero power at 100°C
Case Temperature (note 8)	100°C max.
Cooling	Natural Convection
Storage Temperature	-55°C to +125°C
Humidity	95% RH max. Non condensing
MTBF.. MIL-STD-217F, GB, 25°C, Full Load	XXD3305 500Khrs typ. Others 700Khrs typ.
Thermal Shutdown, Case Temperature	110°C Typical
Dimensions	2.00 x 2.00 x 0.40 inches (50.8 x 50.8 x 10.2 mm)
Case Material	Black Coated Copper with Non-Conductive Base
Weight	65 g

OUTPUT SPECIFICATIONS

Voltage Accuracy	Single/Dual Dual positive Triple	±1.5% max. 3.3V±1.5% max., 5V±3% max. Main ±1.5% max., Auxiliary ±3.0% max.
Voltage Balance(Dual)		±2.0% max.
Transient Response: 75% - 100% Step Load Change (Main Output)	Error Band	±5% Vout nominal
	Recovery Time	< 300µs
Output Voltage Adjustment Range		Single/Dual Vo±10%, Dual Positive±5%
Ripple & Noise, 20MHz BW (Measured with 0.1µF MLCC)		
	2.5V & 3.3V & 5V	50mVpp,max.,
	12V & 15V	75mVpp max.
	Dual ±12V	120mVpk-pk, max.,
	±15V	150mVpk-pkmax.
	Dual positive +3.3V /+5V	100mVpk-pk max.
Temperature Coefficient		±0.02%/°C
Line Regulation (note 1)		
	Single/Dual	±0.5% max.
	Dual positive	±0.5% max.
	Triple	Main ±1.0% max. Auxiliary ±3.0% max.
Load Regulation (note 2)		
	Single	±0.5% max.,
	Dual	±1.0% max.
	Dual positive(note 3)	3.3V ±1.5% max., 5V±4% max.
	Triple	Main ±1.0% max. Auxiliary ±4.0% max.
Cross Regulation (note 4)		+3.3V.....±1.0% max. +5V.....±4.0% max.
Over voltage Protection (Zener Diode Clamp)		2.5V 3.6Vdc typ. 3.3V..... 3.9Vdc typ.,5V6.2Vdc typ. 12V..... 15Vdc typ.,15V18Vdc typ.
Output Current Limit, % Nominal		110%-140%
Output Output Short Circuit Protection		Continuous (hiccup mode)
Start up time		10ms typ.

NOTE

- Measured from high line to low line (dual positive at rated load).
- Measured from full load to 10% load.
- Measured from max. load to zero load, other output at zero load.
- Measured from max. load to 10% load, other output at 10% load.
- Logic Compatibility CMOS or open collector TTL, ref. to -Vin
Module On >3.5VDC to 75VDC or open circuit
Module Off < 1.8VDC.
- Suffix "N" to the model number with negative logic remote On/Off
Module On < 1.8VDC
Module Off >3.5VDC to 75VDC or open circuit
- If +/-sense is not being used, the +sense should be connected to +vout and likewise the -sense should be connected to -Vout.
- Maximum case temperature under any operating condition should not be exceeded 100°C.

EC6E SERIES

20-30 WATT, 4:1 INPUT RANGE

Features

- ◆ 30W Isolated Output
- ◆ 4 : 1 Input Range
- ◆ Six-Sided Shield Metal Case
- ◆ Remote On/Off Control
- ◆ Efficiency to 84%
- ◆ Fixed 200KHz Switching Frequency
- ◆ Regulated Outputs



Mechanical Dimensions

All Dimensions in Inches (mm)
 Tolerance Inches: X.XX=±0.04, X.XXX=±0.010
 Millimeters: X.X=±0.5, X.XX=±0.25

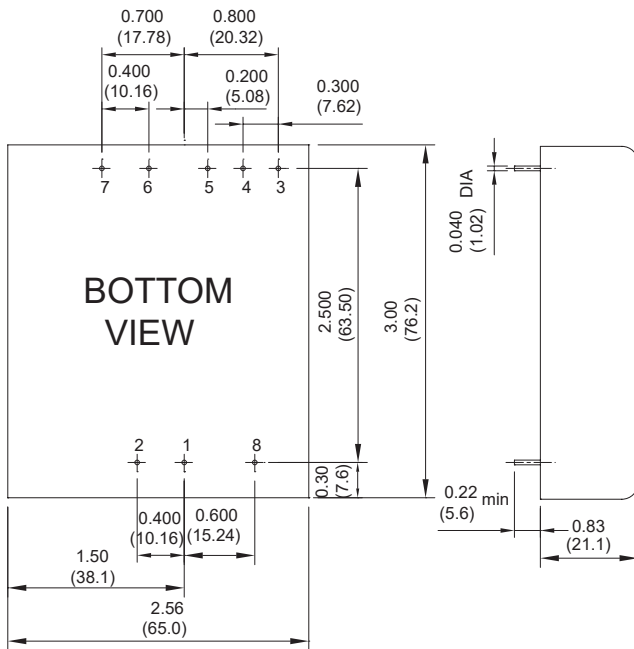

PIN CONNECTION			
PIN	Single Output	Dual Output	Triple Output
1	+Input	+Input	+Input
2	-Input	-Input	-Input
3	+Sense	+Output	+Output
4	Output Trim	Common	Common
5	-Sense	-Output	-Output
6	+Output	No Pin	+5V Output
7	-Output	No Pin	No Pin
8	Remote On/Off Control		

MODEL NUMBER	INPUT VOLTAGE	OUTPUT VOLTAGE	OUTPUT CURRENT	INPUT CURRENT		% EFF.	SIZE
				NO LOAD	FULL LOAD		
EC6E01	9-36 VDC	5 VDC	5000 mA	20 mA	1350 mA	77	2.56"x3"
EC6E02	9-36 VDC	12 VDC	2500 mA	20 mA	1560 mA	80	2.56"x3"
EC6E03	9-36 VDC	15 VDC	2000 mA	20 mA	1560 mA	80	2.56"x3"
EC6E04	9-36 VDC	±12 VDC	±1250 mA	25 mA	1560 mA	80	2.56"x3"
EC6E05	9-36 VDC	±15 VDC	±1000 mA	25 mA	1560 mA	80	2.56"x3"
EC6E06	9-36 VDC	5/±12 VDC	3000/±625 mA	25 mA	1650 mA	76	2.56"x3"
EC6E07	9-36 VDC	5/±15 VDC	3000/±500 mA	25 mA	1650 mA	76	2.56"x3"
EC6E08	9-36 VDC	+5/+12/-5 VDC	3000/600/1000 mA	25 mA	1450 mA	78	2.56"x3"
EC6E11	18-72 VDC	5 VDC	5000 mA	15 mA	670 mA	78	2.56"x3"
EC6E12	18-72 VDC	12 VDC	2500 mA	15 mA	770 mA	81	2.56"x3"
EC6E13	18-72 VDC	15 VDC	2000 mA	15 mA	770 mA	81	2.56"x3"
EC6E14	18-72 VDC	±12 VDC	±1250 mA	20 mA	750 mA	84	2.56"x3"
EC6E15	18-72 VDC	±15 VDC	±1000 mA	20 mA	750 mA	84	2.56"x3"
EC6E16	18-72 VDC	5/±12 VDC	3000/±625 mA	20 mA	790 mA	79	2.56"x3"
EC6E17	18-72 VDC	5/±15 VDC	3000/±500 mA	20 mA	790 mA	80	2.56"x3"
EC6E18	18-72 VDC	+5/+12/-5 VDC	3000/600/1000 mA	20 mA	725 mA	78	2.56"x3"

NOTE: 1. Nominal Input Voltage 24 or 48VDC

Derating Curve

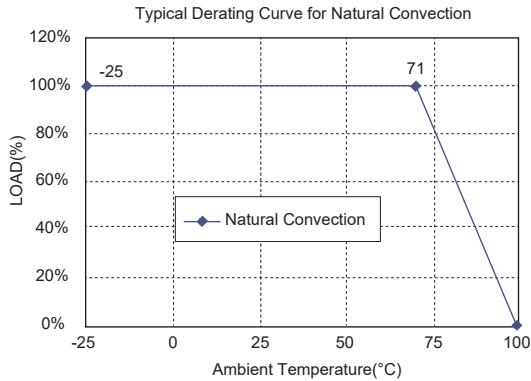

External Output Trim

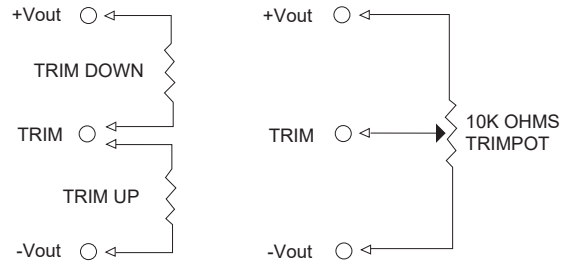

Specification

All Specifications Typical At Nominal Line, Full Load, and 25°C Unless Otherwise Noted

INPUT SPECIFICATIONS

Input Voltage Range	24V 9-36V
	48V 18-72V
Input Filter	Pi Type

OUTPUT SPECIFICATIONS

Voltage Accuracy	
Single Output	±1.0% max.
Dual +Output	±1.0% max.
Dual - Output	±3.0% max.
Triple 5V	±1.0% max.
12V/15V	±5.0% max.
-5V	±2.0% max.
Voltage Balance (Dual)	±1.0% max.
Transient Response	
Single 25% Step Load Change	< 500µs
Dual FL-1/2L±1% Error Band	< 500µs
External Trim Adj. Range	±10%
Ripple and Noise, 20MHz BW	10mV RMS max. 75mV p-p max.
Temperature Coefficient	±0.02%/°C
Short Circuit Protection	Continuous
Line Regulation Single/Dual (note 1)	±0.2% max.
Triple	±1.0% max.
Load Regulation Single/Dual (note 2)	±1.0% max.
Triple	±5.0% max.

GENERAL SPECIFICATIONS

Efficiency	See Table
Isolation Voltage	500 VDC min.
Isolation Resistance	10 ⁹ ohms
Switching Frequency	200KHz typ.
Operating Ambient Temperature Range	-25°C to +71°C
De-rating, Above 71°C	Linearly to Zero power at 100°C
Case Temperature (note 3)	100°C max.
Cooling	Natural Convection
Storage Temperature Range	-55°C to +105°C
EMI/RFI	Six-Sided Continuous Shield
Dimensions	2.56 × 3.00 × 0.83 inches (65.0 × 76.2 × 21.1 mm)
Case Material	Black Coated Copper With Non-Conductive Base
Weight	175 g

NOTE

1. Measured from high line to low line.
2. Measured from full load to 1/4 full load.
3. Maximum case temperature under any operating condition should not be exceeded 100°C.

Output (Pin No.)	Voltage	Amperes	
		Min. (2)	Nom.
6	+5	0.25	3.0
3 & 5	+12 & -12	0.10	0.625
3 & 5	+15 & -15	0.10	0.500
3 & 5	+12 & -5	0.10/0.10	0.60/1.0

Logic Compatibility	CMOS or Open Collector TTL
Ec-On	>+5.5 VDC or Open Circuit
Ec-Off	<1.8 VDC
Shutdown Idle Current	10mA
Control Common	Referenced to Input Minus

NOTE:
1. Maximum total power from all outputs is limited to 30 watts but no output should be allowed to exceed its maximum current
2. Minimum current on each output is required to maintain specified regulation

Rapid Standard-Modification, Value Added & Customized Power Supplies. Cincon offers a high degree of flexibility in product designs.

Cincon provides a broad range of standard products that address the needs of many applications, there are occasions when a standard product doesn't address all your application requirements.

By years of experience in developing our customers with solutions on demand, do not hesitate to talk to Cincon to obtain your preferred products.

Cincon Headquarters

14F, No. 306, Section 4, Hsin Yi Rd., Taipei, Taiwan
Tel: (886-2) 2708-6210
E-mail: sales@cincon.com.tw

Cincon USA

1655 Mesa Verde Ave, Ste 180
Ventura, CA 93003 USA
Tel: (805) 639-3350
E-mail: info@cincon.com

POWER SUPPLY - REQUEST FOR QUOTE - by fax +886 2 2702 9852

Company _____ Date _____

First Name _____ Last Name _____

Country _____ City _____

Address _____

Telephone _____ Fax _____

E-mail _____

Product Type

Application

Output Voltages

Output Currents

Input Voltages

Efficiency

Isolation

Protection

Storage / Operating Temperature Range

Safety Standard

EMC Standard

Mechanical Description

Remarks

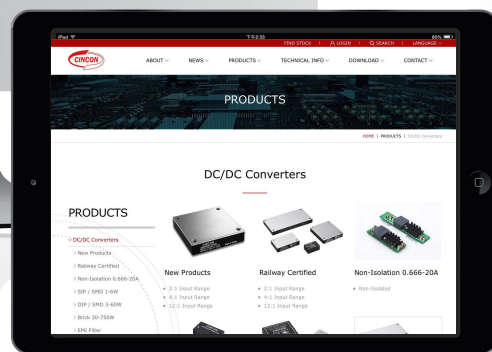
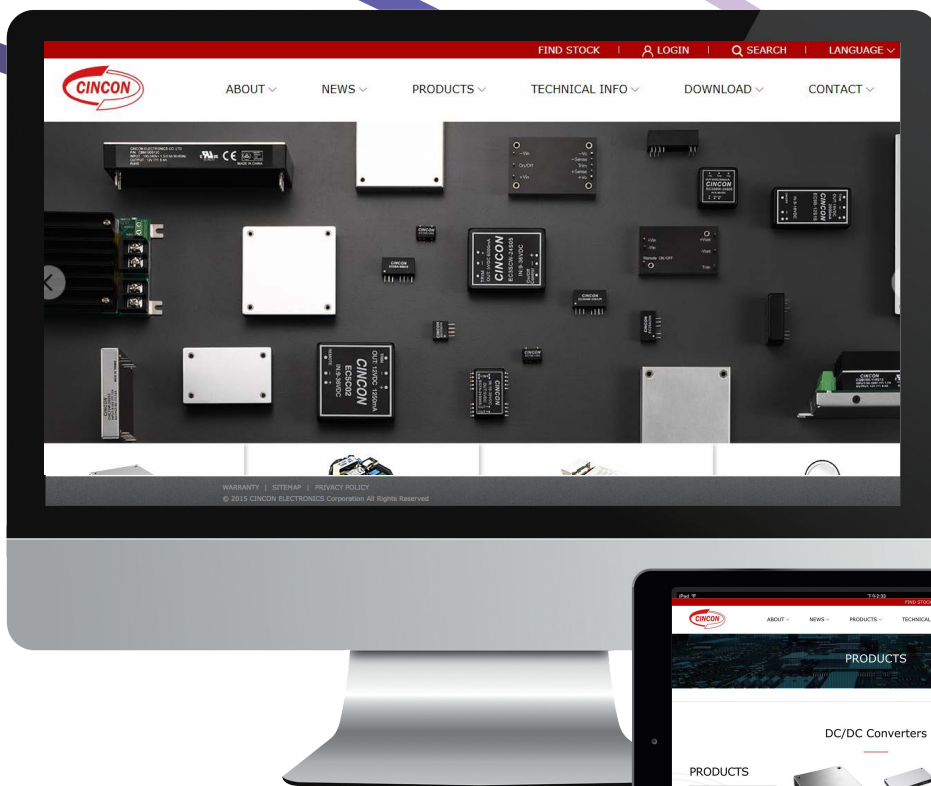

Visit Our Website
WWW.CINCON.COM

On Cincon Website

- ✓ You can download latest datasheets & application notes
- ✓ You can find all new product releases and latest news
- ✓ You can find Cincon sales representative & distributors
- ✓ You can check stock and send product inquiry to us

Let Cincon Power Your Idea



Getronic Vertrieb elektronischer Bauelemente GmbH
Stawedder 29
25462 Rellingen
Germany

Tel: 04101/8040-100
E-Mail: service@getronic.de
www.getronic.de



CINCON HEADQUARTERS

14F , No. 306, Section 4, Hsin Yi Road Taipei, Taiwan, R.O.C.
Tel : (886-2) 2708-6210 | Fax : (886-2) 2702-9852
E-mail : sales@cincon.com.tw

CINCON USA

1655 Mesa Verde Ave, Ste 180 Ventura , CA 93003 USA
Tel : (805) 639-3350 | Fax : (805) 639-4101
E-mail : info@cincon.com

WWW.CINCON.COM